



EUROPEAN COMMISSION
DIRECTORATE-GENERAL JRC
JOINT RESEARCH CENTRE
Institute for Prospective Technological Studies

Integrated Pollution Prevention and Control

Reference Document on
Best Available Techniques in the

Ceramic Manufacturing Industry

Dated December 2006

This document is one of a series of foreseen documents as below (at the time of writing, not all documents have been finalised):

Reference Document on Best Available Techniques...	Code
Large Combustion Plants	LCP
Mineral Oil and Gas Refineries	REF
Production of Iron and Steel	I&S
Ferrous Metals Processing Industry	FMP
Non Ferrous Metals Industries	NFM
Smitheries and Foundries Industry	SF
Surface Treatment of Metals and Plastics	STM
Cement and Lime Manufacturing Industries	CL
Glass Manufacturing Industry	GLS
<i>Ceramic Manufacturing Industry</i>	<i>CER</i>
Large Volume Organic Chemical Industry	LVOC
Manufacture of Organic Fine Chemicals	OFC
Production of Polymers	POL
Chlor – Alkali Manufacturing Industry	CAK
Large Volume Inorganic Chemicals - Ammonia, Acids and Fertilisers Industries	LVIC-AAF
Large Volume Inorganic Chemicals - Solid and Others industry	LVIC-S
Production of Speciality Inorganic Chemicals	SIC
Common Waste Water and Waste Gas Treatment/Management Systems in the Chemical Sector	CWW
Waste Treatments Industries	WT
Waste Incineration	WI
Management of Tailings and Waste-Rock in Mining Activities	MTWR
Pulp and Paper Industry	PP
Textiles Industry	TXT
Tanning of Hides and Skins	TAN
Slaughterhouses and Animals By-products Industries	SA
Food, Drink and Milk Industries	FDM
Intensive Rearing of Poultry and Pigs	ILF
Surface Treatment Using Organic Solvents	STS
Industrial Cooling Systems	CV
Emissions from Storage	ESB
Reference Document...	
General Principles of Monitoring	MON
Economics and Cross-Media Effects	ECM
Energy Efficiency Techniques	ENE

EXECUTIVE SUMMARY

The BAT (Best Available Techniques) Reference Document (BREF) entitled ‘Ceramic Manufacturing (CER)’ reflects an information exchange carried out under Article 16(2) of Council Directive 96/61/EC (IPPC Directive). This executive summary describes the main findings, a summary of the principal BAT conclusions and the associated consumption and emission levels. It should be read in conjunction with the preface, which explains this document’s objectives; how it is intended to be used and legal terms. It can be read and understood as a standalone document but, as a summary, it does not present all the complexities of this full document. It is therefore not intended as a substitute for this full document as a tool in BAT decision making and it has to be stressed again that this summary cannot correctly be interpreted unless it is read in conjunction with Chapters 4 and 5.

SCOPE OF THIS DOCUMENT

This document addresses the industrial activities specified in Section 3.5 of Annex I to Directive 96/61/EC, namely:

‘3.5. Installations for the manufacture of ceramic products by firing, in particular roofing tiles, bricks, refractory bricks, tiles, stoneware or porcelain, with a production capacity exceeding 75 tonnes per day, and/or with a kiln capacity exceeding 4 m³ and with a setting density per kiln exceeding 300 kg/m³’.

For the purposes of this document the industrial activities falling within this description will be referred to as the ‘ceramic industry’. The major sectors which are based on the ceramic products (ceramics) manufactured are as follows:

- wall and floor tiles
- bricks and roof tiles
- table- and ornamentalware (household ceramics)
- refractory products
- sanitaryware
- technical ceramics
- vitrified clay pipes
- expanded clay aggregates
- inorganic bonded abrasives.

In addition to the basic manufacturing activities, this document covers the directly associated activities which could have an effect on emissions or pollution. Thus, this document includes activities from the preparation of raw materials to the dispatch of finished products. Certain activities, such as the quarrying of raw materials, are not covered because they are not considered to be directly associated with the primary activity.

THE CERAMIC INDUSTRY

Generally the term ‘ceramics’ (ceramic products) is used for inorganic materials (with possibly some organic content), made up of non-metallic compounds and made permanent by a firing process. In addition to clay based materials, today ceramics include a multitude of products with a small fraction of clay or none at all. Ceramics can be glazed or unglazed, porous or vitrified.

Firing of ceramic bodies induces time-temperature transformation of the constituent minerals, usually into a mixture of new minerals and glassy phases. Characteristic properties of ceramic products include high strength, wear resistance, long service life, chemical inertness and non-toxicity, resistance to heat and fire, (usually) electrical resistance and sometimes also a specific porosity.

Clay raw materials are widely distributed throughout Europe, so ceramic products like bricks which are relatively inexpensive (but which incur high transport costs due to their weight) are manufactured in virtually all Member States. Building traditions and heritage considerations result in different unit sizes from country to country. More specialised products which command higher prices tend to be mainly produced in a few countries, which have the necessary special raw materials and – equally important – traditions of skill and expertise.

KEY ENVIRONMENTAL ISSUES

Depending on the specific production processes, plants manufacturing ceramic products cause emissions to be released into air, water and land (waste). Additionally, the environment can be affected by noise and unpleasant smells. The type and quantity of air pollution, wastes and waste water depend on different parameters. These parameters are, e.g. the raw materials used, the auxiliary agents employed, the fuels used and the production methods:

- emissions to air: particulate matter/dust, soot, gaseous emissions (carbon oxides, nitrogen oxides, sulphur oxides, inorganic fluorine and chlorine compounds, organic compounds and heavy metals) can arise from the manufacture of ceramic products
- emissions to water: process waste water mainly contains mineral components (insoluble particulate matter) and also further inorganic materials, small quantities of numerous organic materials as well as some heavy metals
- process losses/waste: process losses originating from the manufacture of ceramic products, mainly consist of different kinds of sludge, broken ware, used plaster moulds, used sorption agents, solid residues (dust, ashes) and packaging waste
- energy consumption/CO₂ emissions: all sectors of the ceramic industry are energy intensive, as a key part of the process involves drying followed by firing to temperatures of between 800 and 2000 °C. Today natural gas, liquefied petroleum gas (propane and butane) and fuel oil EL are mainly used for firing, while heavy fuel oil, liquefied natural gas (LNG), biogas/biomass, electricity and solid fuels (e.g. coal, petroleum coke) can also play a role as energy sources for burners.

APPLIED PROCESSES AND TECHNIQUES

The manufacture of ceramic products takes place in different types of kilns, with a wide range of raw materials and in numerous shapes, sizes and colours. The general process of manufacturing ceramic products, however, is rather uniform, besides the fact that for the manufacture of wall and floor tiles, household ceramics, sanitaryware and technical ceramics often a multiple stage firing process is used.

In general, raw materials are mixed and cast, pressed or extruded into shape. Water is regularly used for a thorough mixing and shaping. This water is evaporated in dryers and the products are either placed by hand in the kiln – especially in the case of periodically operated shuttle kilns – or placed onto carriages that are transferred through continuously operated tunnel or roller hearth kilns. For the manufacture of expanded clay aggregates, rotary kilns are used.

During firing a very accurate temperature gradient is necessary to ensure that the products obtain the right treatment. Afterwards controlled cooling is necessary, so that the products release their heat gradually and preserve their ceramic structure. Then the products are packaged and stored for delivery.

EMISSIONS AND CONSUMPTIONS

Emissions

The processing of clays and other ceramic raw materials inevitably leads to dust formation – especially in the case of dry materials. Drying, (including spray drying), comminution (grinding, milling), screening, mixing and conveying can all result in a release of fine dust. Some dust also forms during the decorating and firing of the ware, and during the machining or finishing operations on the fired ware. Dust emissions are not only derived from the raw materials as described above, but also the fuels contribute to these emissions to air.

The gaseous compounds released during drying and firing are mainly derived from the raw materials, but fuels also contribute gaseous pollutants. In particular these are SO_x, NO_x, HF, HCl, VOC and heavy metals.

Process waste water is generated mainly when clay materials are flushed out and suspended in flowing water during the manufacturing process and equipment cleaning, but emissions to water also occur during the operation of wet off-gas scrubbers. The water added directly to ceramic body mixes is subsequently evaporated into the air during the drying and firing stages.

Process losses can often be recycled and re-used within the plant due to product specifications or process requirements. Materials, which cannot be recycled internally, leave the plant to be used in other industries or to be supplied to external waste recycling or waste disposal facilities.

Consumptions

The primary energy use in ceramic manufacturing is for kiln firing and, in many processes, drying of intermediates or shaped ware is also energy intensive.

Water is used in virtually all ceramic processes and good quality water is essential for the preparation of clays and glaze slips, clay bodies for extrusion, ‘muds’ for moulding, preparation of spray dried powders, wet grinding/milling and washing or cleaning operations.

A vast range of raw materials is consumed by the ceramic industry. These include the main body forming materials, involving high tonnages, and various additives, binders and decorative surface-applied materials which are used on a lesser scale.

TECHNIQUES TO CONSIDER IN THE DETERMINATION OF BAT

Important issues for the implementation of IPPC in the ceramic industry are reduction of emissions to air and water, efficient energy, raw material and water usage, minimisation, recovery and recycling of process losses/waste and process waste water, as well as effective management systems.

The issues above are addressed by a variety of process-integrated and end-of-pipe techniques, taking into account the applicability in the nine individual ceramic sectors. In this context, approximately 50 techniques for pollution prevention and control are presented in this document, under the following seven thematic headings:

Reduction of energy consumption (energy efficiency)

The choices of energy source, firing technique and heat recovery method are central to the design of the kiln and are also some of the most important factors affecting the environmental performance and energy efficiency of the manufacturing process.

Executive Summary

The main techniques for reducing energy usage, which can be applied individually or in combination, are listed below and are discussed in detail in this document:

- improved design of kilns and dryers
- recovery of excess heat from kilns
- cogeneration/combined heat and power plants
- substitution of heavy fuel oil and solid fuels by low emission fuels
- modification of ceramic bodies.

Emissions of dust (particulate matter)

To prevent diffuse and channelled dust emissions, techniques and measures are described, which can be applied individually or in combination. These are:

- measures for dusty operations
- measures for bulk storage areas
- separation/filter systems.

Gaseous compounds

To prevent emissions of gaseous air pollutants (in particular SO_{xx}, NO_{xx}, HF, HCl, VOC), primary and secondary measures/techniques are described, which can be applied individually or in combination. These are:

- reduction of pollutant precursor input
- addition of calcium rich additives
- process optimisation
- sorption plants (adsorbers, absorbers)
- afterburning.

Process waste water

Objectives and solutions for the reduction of process waste water (emissions and consumption) are presented in the form of process optimisation measures and process waste water treatment systems. For the reduction of process waste water emissions and lower water consumption, combinations of these measures are usually applied.

Process losses/waste

Objectives and solutions for the reduction of process losses/waste are presented regarding sludge arising in the manufacture of ceramic products and solid process losses/solid waste in the form of process optimisation, recycling and re-use measures/techniques. For the reduction of process losses/waste, combinations of these measures/techniques are usually applied.

General considerations concerning noise

Possibilities for the reduction of noise occurring in the several steps during the manufacturing processes of ceramic products are demonstrated. A general summary and overview for the reduction of noise is presented.

Environmental management tools/environmental management systems (EMS)

EMS are essential for minimising the environmental impact of industrial activities in general, with some measures that are specifically important to ceramics. Therefore EMS are presented in this document as tools that operators can use to address these design, construction, maintenance, operation and decommissioning issues in a systematic, demonstrable way.

BAT FOR CERAMIC MANUFACTURING

The BAT chapter (Chapter 5) identifies those techniques that are considered to be BAT in a general sense, based mainly on the information in Chapter 4, taking into account the Article 2(11) definition of best available techniques and the considerations listed in Annex IV to the Directive. As described more fully in the Preface, the BAT chapter does not set or propose emission limit values but suggests consumption and emission values that are associated with the use of BAT as well as a selection of BAT. The determination of appropriate permit conditions will involve taking account of local, site-specific factors such as the technical characteristics of the installation concerned, its geographical location and the local environmental conditions. In the case of existing installations, the economic and technical viability of upgrading them also needs to be taken into account.

The following paragraphs summarise the key BAT conclusions for the ceramic manufacturing industry relating to the most relevant environmental issues. The BAT conclusions are set out on two levels. Section 5.1 presents generic BAT conclusions, i.e. those that are generally applicable to the whole ceramic industry. Section 5.2 contains more specific BAT conclusions, i.e. those for the nine major ceramic sectors under the scope. 'Best Available Techniques' for a specific installation will usually be the use of one individual or a combination of the techniques and measures listed in the relevant chapter under the generic and sector specific sections.

It has to be noted, that in this Executive Summary, the BAT conclusions of this document are summarised as short versions. To read the relevant full BAT conclusions, see the corresponding sections in Chapter 5 of this document.

Generic BAT

The generic BAT section contains general BAT conclusions regarding all nine sectors explained and described in detail in this document.

It has to be noted, that in this Executive Summary, the BAT conclusions of this document are summarised as short versions. It has to be stressed again that this BAT summary as well as the associated BAT AEL ranges mentioned in the summary, cannot correctly be interpreted unless it is read in conjunction with Chapter 4 and the relevant full BAT conclusions in Chapter 5 of this document.

Environmental management:

Implement and adhere to an Environmental Management System (EMS) that incorporates, as appropriate to individual circumstances, the features listed in Section 5.1.1 of this document.

Energy consumption:

Reduce energy consumption by applying a combination of several techniques, which are listed in Section 5.1.2.a of this document and can be summarised as:

- improved design of kilns and dryers
- recovery of excess heat from kilns, especially from their cooling zone
- applying a fuel switch in the kiln firing process (substitution of heavy fuel oil and solid fuels by low emission fuels)
- modification of ceramic bodies.

Reduce primary energy consumption by applying cogeneration/combined heat and power plants on the basis of useful heat demand, within energy regulatory schemes which are economically viable.

Diffuse dust emissions:

Reduce diffuse dust emissions by applying a combination of several techniques, which are listed in Section 5.1.3.1 of this document and can be summarised as measures for dusty operations and bulk storage area measures.

Channelled dust emissions from dusty operations other than from drying, spray drying or firing:

Reduce channelled dust emissions from dusty operations to 1 – 10 mg/m³, as the half hourly average value, by applying bag filters. The range may be higher depending on specific operating conditions.

Dust emissions from drying processes:

Keep dust emissions from drying processes in the range 1 – 20 mg/m³ as the daily average value by cleaning the dryer, by avoiding the accumulation of dust residues in the dryer and by adopting adequate maintenance protocols.

Dust emissions from kiln firing processes:

Reduce dust emissions from the flue-gases of kiln firing processes to 1 – 20 mg/m³ as the daily average value by applying a combination of several techniques, which are listed in Section 5.1.3.4 of this document. These techniques can be summarised as utilisation of low ash fuels and minimisation of dust formation caused by the charging of the ware to be fired in the kiln.

By applying dry flue-gas cleaning with a filter, a dust emission level of less than 20 mg/m³ in the cleaned flue-gas is BAT and by applying cascade-type packed bed adsorbers, a dust emission level of less than 50 mg/m³ in the cleaned flue-gas is BAT (for expanded clay aggregates, see the sector specific BAT).

Gaseous compounds, primary measures/techniques:

Reduce the emissions of gaseous compounds (i.e. HF, HCl, SO_x, VOC, heavy metals) from flue-gases of kiln firing processes by applying one or a combination of several techniques, which are listed in Section 5.1.4.1 of this document. These techniques can be summarised as reducing the input of pollutant precursors and heating curve optimisation.

Keep the emissions of NO_x from flue-gases of kiln firing processes below 250 mg/m³, as the daily average value stated as NO₂, for kiln gas temperatures below 1300 °C, or below 500 mg/m³, as the daily average value stated as NO₂, for kiln gas temperatures of 1300 °C and higher, by applying a combination of primary measures/techniques as listed in Sections 4.3.1 and 4.3.3 of the document (for expanded clay aggregates, see the sector specific BAT).

Keep the emissions of NO_x from off-gases of cogeneration engines below 500 mg/m³, as the daily average value stated as NO₂, by applying process optimisation measures.

Gaseous compounds, secondary measures/techniques and in combination with primary measures/techniques:

Reduce the emissions of gaseous inorganic compounds from flue-gases of kiln firing processes by applying one of several techniques which are listed in Section 5.1.4.2 of this document and can be summarised as cascade-type packed bed adsorbers and dry flue-gas cleaning with a filter.

The following table from Section 5.1.4.2 shows BAT emission levels for gaseous inorganic compounds from flue-gases of kiln firing processes by applying a combination of primary measures/techniques as stated in Section 5.1.4.1.a and/or secondary measures/techniques as stated in Section 5.1.4.2 of this document.

Parameter	Unit, as a daily average value	BAT AEL ¹⁾
Fluoride stated as HF	mg/m ³	1 – 10 ²⁾
Chloride stated as HCl	mg/m ³	1 – 30 ³⁾
SO _x stated as SO ₂ Sulphur content in raw material ≤0.25 %	mg/m ³	<500
SO _x stated as SO ₂ Sulphur content in raw material >0.25 %	mg/m ³	500 – 2000 ⁴⁾
¹⁾ The ranges depend on the content of the pollutant (precursor) in the raw materials, i.e. for firing processes of ceramic products with a low content of the pollutant (precursor) in the raw materials, lower levels within the range are BAT and for firing processes of ceramic products with a high content of the pollutant (precursor) in the raw materials, higher levels within the range are BAT AELs.		
²⁾ The higher BAT level can be lower depending on the characteristics of the raw material.		
³⁾ The higher BAT level can be lower depending on the characteristics of the raw material. Also, the higher BAT AEL should not prevent the re-use of waste water.		
⁴⁾ The higher BAT level only applies to raw material with an extremely high sulphur content.		

Process waste water (emissions and consumption):

Reduce water consumption by applying several process optimisation measures as listed in Section 4.4.5.1 of this document, which can be applied individually or in combination.

Clean process waste water by applying several process waste water treatment systems as listed in Section 4.4.5.2 of this document, which can be applied individually or in combination to ensure that the water is adequately cleaned to be re-used in the manufacturing process or to be discharged directly into watercourses or indirectly into a municipal waste water sewerage system.

The following BAT table from Section 5.1.5 shows BAT associated emission levels of pollutants in waste water discharges:

Parameter	Unit	BAT AEL (2 hours composite sample)
Suspended solids	mg/l	50.0
AOX	mg/l	0.1
Lead (Pb)	mg/l	0.3
Zinc (Zn)	mg/l	2.0
Cadmium (Cd)	mg/l	0.07

If more than 50 % of the process water is re-used in the manufacturing processes, higher concentrations of these pollutants may still be BAT AELs, as long as the specific pollutant load per production amount (kg of processed raw material) is not higher than the pollutant load resulting from a water recycling rate of less than 50 %.

Sludge:

Recycle/re-use sludge by applying sludge recycling systems and/or sludge re-use in other products.

Solid process losses/solid waste:

Reduce solid process losses/solid waste by applying a combination of several techniques, which are listed in Section 5.1.7 of this document and can be summarised as:

- feedback of unmixed raw materials
- feedback of broken ware into the manufacturing process
- use of solid process losses in other industries
- electronic controlling of firing
- applying optimised setting.

Noise:

Reduce noise by applying a combination of several techniques, which are listed in Section 5.1.8 of this document and can be summarised as:

- enclosure of units
- vibration insulation of units
- using silencers and slow rotating fans
- situating windows, gates and noisy units away from neighbours
- sound insulation of windows and walls
- closing windows and gates
- carrying out noisy (outdoor) activities only during the day
- good maintenance of the plant.

Sector specific BAT

The sector specific BAT section contains specific BAT conclusions regarding each of the nine sectors explained and described in this document. It has to be stressed again that this BAT summary as well as the associated BAT AEL ranges mentioned in the summary, cannot correctly be interpreted unless it is read in conjunction with Chapter 4 and the relevant full BAT conclusions in Chapter 5 of this document.

Channelled dust emissions:

Wall and floor tiles, household ceramics, sanitaryware, technical ceramics, vitrified clay pipes:

Reduce channelled dust emissions from spray glazing processes to 1 – 10 mg/m³, as the half hourly average value, by applying bag filters or sintered lamellar filters.

Wall and floor tiles, household ceramics, technical ceramics:

Reduce channelled dust emissions from spray drying processes to 1 – 30 mg/m³, as the half hourly average value, by applying bag filters, or to 1 – 50 mg/m³ by applying cyclones in combination with wet dust separators for existing installations, if the rinsing water can be re-used.

Expanded clay aggregates:

Reduce channelled dust emissions from hot off-gases to 5 – 50 mg/m³, as the daily average value, by applying electrostatic precipitators or wet dust separators.

Dust emissions from kiln firing processes:

Wall and floor tiles:

Reduce dust emissions from flue-gases of kiln firing processes to 1 – 5 mg/m³, as the daily average value, by applying dry flue-gas cleaning with a bag filter.

Gaseous compounds/primary measures/techniques:

Bricks and roof tiles:

Reduce the emissions of gaseous compounds (i.e. HF, HCl, SO_x) from the flue-gases of kiln firing processes by the addition of calcium rich additives.

Expanded clay aggregates:

Keep the emissions of NO_x from the flue-gases of rotary kiln firing processes below 500 mg/m³, as the daily average value stated as NO₂, by applying a combination of primary measures/techniques.

Gaseous compounds/secondary measures/techniques:

Wall and floor tiles, household ceramics, sanitaryware, technical ceramics:

Reduce the emissions of gaseous inorganic compounds from the flue-gases of kiln firing processes by applying module adsorbers, especially for lower flue-gas flowrates (below 18000 m³/h) and when raw gas concentrations of inorganic compounds other than HF (SO₂, SO₃, HCl) and of dust are low.

Wall and floor tiles:

Reduce the emissions of HF from the flue-gases of kiln firing processes to 1 – 5 mg/m³, as the daily average value, by applying, e.g. dry flue-gas cleaning with a bag filter.

Volatile organic compounds:

Bricks and roof tiles, refractory products, technical ceramics, inorganic bonded abrasives:

Reduce the emissions of volatile organic compounds from the flue-gases of firing processes – with raw gas concentrations of more than 100 to 150 mg/m³, depending on the raw gas characteristics, e.g. composition, temperature – to 5 – 20 mg/m³, as the daily average value stated as total C, by applying thermal afterburning either in a one or a three chamber thermoreactor.

Refractory products treated with organic compounds:

Reduce the emissions of volatile organic compounds in low off-gas volumes from the treatment with organic compounds by applying activated carbon filters. For high off-gas volumes, BAT is to reduce the emissions of volatile organic compounds from the treatment with organic compounds by applying thermal afterburning to 5 – 20 mg/m³.

Re-use of process waste water:

Wall and floor tiles, household ceramics, sanitaryware:

Re-use process waste water in the manufacturing process with process waste water recycling ratios of 50 – 100 % (for wall and floor tiles, depending on the type of tile to be manufactured), or of 30 – 50 % (for household ceramics and sanitaryware), by applying a combination of process optimisation measures and process waste water treatment systems.

Re-use of sludge:

Wall and floor tiles:

Re-use the sludge arising from process waste water treatment in the ceramic body preparation process in a ratio of 0.4 – 1.5 % per weight of added dry sludge to the ceramic body, by applying a sludge recycling system, when applicable.

Solid process losses/solid waste:

Household ceramics, sanitaryware, technical ceramics, refractory products:

Reduce the amount of solid process losses/solid waste in the form of used plaster moulds from the shaping by applying one individual or a combination of the following measures:

- replacing plaster moulds by polymer moulds
- replacing plaster moulds by metal moulds
- use of vacuum plaster mixers
- re-use of used plaster moulds in other industries.

EMERGING TECHNIQUES

Some new techniques for the minimisation of environmental impacts are under development or in limited use and are considered emerging techniques. Five of these are discussed in Chapter 6:

- radiant-tube burners
- microwave assisted firing and microwave dryers
- a new type of drying system for refractory products
- advanced process waste water management with integrated glaze recovery
- lead-free glazing of high quality table porcelain.

CONCLUDING REMARKS

The Concluding Remarks Chapter contains information on the milestones in developing this document, the degree of consensus reached on the BAT proposals for the ceramic industry and the information gaps that still exist, in particular regarding data which were not provided within the time period of the information exchange and, therefore, could not be taken in consideration. Recommendations for further research and information gathering are given and, finally, recommendations for updating the BREF on ceramic manufacturing.

The EC is launching and supporting, through its RTD programmes, a series of projects dealing with clean technologies, emerging effluent treatment and recycling technologies and management strategies. Potentially these projects could provide a useful contribution to future BREF reviews. Readers are therefore invited to inform the EIPPCB of any research results which are relevant to the scope of this document (see also the preface of this document).

PREFACE

1. Status of this document

Unless otherwise stated, references to “the Directive” in this document means the Council Directive 96/61/EC on integrated pollution prevention and control. As the Directive applies without prejudice to Community provisions on health and safety at the workplace, so does this document.

This document forms part of a series presenting the results of an exchange of information between EU Member States and industries concerned on best available technique (BAT), associated monitoring, and developments in them. *[It is published by the European Commission pursuant to Article 16(2) of the Directive, and must therefore be taken into account in accordance with Annex IV of the Directive when determining “best available techniques”].

* Note: bracket will be removed once the procedure of publication by the Commission is completed.

2. Relevant legal obligations of the IPPC Directive and the definition of BAT

In order to help the reader understand the legal context in which this document has been drafted, some of the most relevant provisions of the IPPC Directive, including the definition of the term “best available techniques”, are described in this preface. This description is inevitably incomplete and is given for information only. It has no legal value and does not in any way alter or prejudice the actual provisions of the Directive.

The purpose of the Directive is to achieve integrated prevention and control of pollution arising from the activities listed in its Annex I, leading to a high level of protection of the environment as a whole. The legal basis of the Directive relates to environmental protection. Its implementation should also take account of other Community objectives such as the competitiveness of the Community’s industry thereby contributing to sustainable development.

More specifically, it provides for a permitting system for certain categories of industrial installations requiring both operators and regulators to take an integrated, overall look at the polluting and consuming potential of the installation. The overall aim of such an integrated approach must be to improve the management and control of industrial processes so as to ensure a high level of protection for the environment as a whole. Central to this approach is the general principle given in Article 3 that operators should take all appropriate preventative measures against pollution, in particular through the application of best available techniques enabling them to improve their environmental performance.

The term “best available techniques” is defined in Article 2(11) of the Directive as “the most effective and advanced stage in the development of activities and their methods of operation which indicate the practical suitability of particular techniques for providing in principle the basis for emission limit values designed to prevent and, where that is not practicable, generally to reduce emissions and the impact on the environment as a whole.” Article 2(11) goes on to clarify further this definition as follows:

“techniques” includes both the technology used and the way in which the installation is designed, built, maintained, operated and decommissioned;

“available” techniques are those developed on a scale which allows implementation in the relevant industrial sector, under economically and technically viable conditions, taking into consideration the costs and advantages, whether or not the techniques are used or produced inside the Member State in question, as long as they are reasonably accessible to the operator;

“best” means most effective in achieving a high general level of protection of the environment as a whole.

Furthermore, Annex IV of the Directive contains a list of “considerations to be taken into account generally or in specific cases when determining best available techniques... bearing in mind the likely costs and benefits of a measure and the principles of precaution and prevention”. These considerations include the information published by the Commission pursuant to Article 16(2).

Competent authorities responsible for issuing permits are required to take account of the general principles set out in Article 3 when determining the conditions of the permit. These conditions must include emission limit values, supplemented or replaced where appropriate by equivalent parameters or technical measures. According to Article 9(4) of the Directive, these emission limit values, equivalent parameters and technical measures must, without prejudice to compliance with environmental quality standards, be based on the best available techniques, without prescribing the use of any technique or specific technology, but taking into account the technical characteristics of the installation concerned, its geographical location and the local environmental conditions. In all circumstances, the conditions of the permit must include provisions on the minimisation of long-distance or transboundary pollution and must ensure a high level of protection for the environment as a whole.

Member States have the obligation, according to Article 11 of the Directive, to ensure that competent authorities follow or are informed of developments in best available techniques.

3. Objective of this Document

Article 16(2) of the Directive requires the Commission to organise “an exchange of information between Member States and the industries concerned on best available techniques, associated monitoring and developments in them”, and to publish the results of the exchange.

The purpose of the information exchange is given in recital 25 of the Directive, which states that “the development and exchange of information at Community level about best available techniques will help to redress the technological imbalances in the Community, will promote the worldwide dissemination of limit values and techniques used in the Community and will help the Member States in the efficient implementation of this Directive.”

The Commission (Environment DG) established an information exchange forum (IEF) to assist the work under Article 16(2) and a number of technical working groups have been established under the umbrella of the IEF. Both IEF and the technical working groups include representation from Member States and industry as required in Article 16(2).

The aim of this series of documents is to reflect accurately the exchange of information which has taken place as required by Article 16(2) and to provide reference information for the permitting authority to take into account when determining permit conditions. By providing relevant information concerning best available techniques, these documents should act as valuable tools to drive environmental performance.

4. Information Sources

This document represents a summary of information collected from a number of sources, including in particular the expertise of the groups established to assist the Commission in its work, and verified by the Commission services. All contributions are gratefully acknowledged.

5. How to understand and use this document

The information provided in this document is intended to be used as an input to the determination of BAT in specific cases. When determining BAT and setting BAT-based permit conditions, account should always be taken of the overall goal to achieve a high level of protection for the environment as a whole.

The rest of this section describes the type of information that is provided in each section of this document.

Chapters 1 and 2 provide general information on the ceramic manufacturing industry and on the industrial processes used within this industry. Chapter 3 provides data and information concerning current emission and consumption levels reflecting the situation in existing installations at the time of writing.

Chapter 4 describes in more detail the emission reduction and other techniques that are considered to be most relevant for determining BAT and BAT-based permit conditions. This information includes the consumption and emission levels considered achievable by using the technique, some idea of the costs and the cross-media issues associated with the technique, and the extent to which the technique is applicable to the range of installations requiring IPPC permits, for example new, existing, large or small installations. Also the applicability of a technique in the different sectors of the ceramic industry is taken into consideration. Techniques that are generally seen as obsolete are not included.

Chapter 5 presents the techniques and the emission and consumption levels that are considered to be compatible with BAT in a general sense. The purpose is thus to provide general indications regarding the emission and consumption levels that can be considered as an appropriate reference point to assist in the determination of BAT-based permit conditions or for the establishment of general binding rules under Article 9(8). It should be stressed, however, that this document does not propose emission limit values. The determination of appropriate permit conditions will involve taking account of local, site-specific factors such as the technical characteristics of the installation concerned, its geographical location and the local environmental conditions. In the case of existing installations, the economic and technical viability of upgrading them also needs to be taken into account. Even the single objective of ensuring a high level of protection for the environment as a whole will often involve making trade-off judgements between different types of environmental impact, and these judgements will often be influenced by local considerations.

Although an attempt is made to address some of these issues, it is not possible for them to be considered fully in this document. The techniques and levels presented in Chapter 5 will therefore not necessarily be appropriate for all installations. On the other hand, the obligation to ensure a high level of environmental protection including the minimisation of long-distance or transboundary pollution implies that permit conditions cannot be set on the basis of purely local considerations. It is therefore of the utmost importance that the information contained in this document is fully taken into account by permitting authorities.

Since the best available techniques change over time, this document will be reviewed and updated as appropriate. All comments and suggestions should be made to the European IPPC Bureau at the Institute for Prospective Technological Studies at the following address:

Edificio Expo, c/ Inca Garcilaso, s/n, E-41092 Sevilla, Spain
Telephone: +34 95 4488 284
Fax: +34 95 4488 426
e-mail: JRC-IPTS-EIPPCB@ec.europa.eu
Internet: <http://eippcb.jrc.es>

Best Available Techniques Reference Document on Ceramic Manufacturing

EXECUTIVE SUMMARY	I
PREFACE	XI
SCOPE	XXV
1 GENERAL INFORMATION ON CERAMIC MANUFACTURING	1
1.1 Historical origins	1
1.2 Characteristics of ceramics	1
1.3 Geographical distribution and general economic considerations	3
1.4 Key environmental issues	4
1.5 Ceramics sectors	5
1.5.1 Bricks and roof tiles	6
1.5.2 Vitrified clay pipes	7
1.5.3 Refractory products	8
1.5.4 Expanded clay aggregates	9
1.5.5 Wall and floor tiles	9
1.5.6 Table- and ornamentalware (household ceramics)	11
1.5.7 Sanitaryware	11
1.5.8 Technical ceramics	12
1.5.9 Inorganic bonded abrasives	12
2 APPLIED PROCESSES AND TECHNIQUES IN CERAMIC MANUFACTURING	13
2.1 Raw materials	13
2.2 General production process description	14
2.2.1 Storage and transport of raw materials	15
2.2.2 Preparation of raw materials	15
2.2.2.1 Pre-drying	15
2.2.2.2 Pre-blending	15
2.2.2.3 Weathering/souring	15
2.2.2.4 Primary and secondary crushing, grinding and screening	16
2.2.2.5 Dry or wet milling (grinding)	16
2.2.2.6 Dry screening/air classification	16
2.2.2.7 Spray drying	17
2.2.2.8 Calcining	17
2.2.2.9 Synthetic base materials	17
2.2.2.10 Frits and glazes, glaze preparation	17
2.2.3 Component mixing	18
2.2.3.1 General	18
2.2.3.2 Continuous mixers	18
2.2.3.3 Batch mixers	18
2.2.4 Shaping/forming of ware	19
2.2.4.1 General	19
2.2.4.2 Pressing	19
2.2.4.2.1 Mechanical pressing	19
2.2.4.2.2 Hydraulic pressing	19
2.2.4.2.3 Impact pressing	19
2.2.4.2.4 Friction pressing	19
2.2.4.2.5 Isostatic pressing	20
2.2.4.3 Extrusion	20
2.2.4.4 Moulding	20
2.2.4.5 Slip casting	20
2.2.4.6 Fusion casting	21
2.2.5 Drying of ceramic products	21
2.2.5.1 General	21
2.2.5.2 Hot floor dryers	21
2.2.5.3 Chamber dryers (intermittent)	21
2.2.5.4 Tunnel dryers (continuous)	22
2.2.5.5 Vertical 'basket' dryers	22
2.2.5.6 Horizontal multi-deck roller dryers	22

2.2.5.7	Dehumidifying dryers	22
2.2.5.8	Infrared and microwave dryers	23
2.2.6	Surface treatment and decoration of ceramic products	23
2.2.6.1	Texturing of clay products	23
2.2.6.2	Applied facings	23
2.2.6.3	Glazing, engobing and other decorating techniques	23
2.2.7	Firing	24
2.2.7.1	Aims of firing	24
2.2.7.2	Physico-chemical changes during firing	24
2.2.7.3	Intermittent (periodic) kilns	25
2.2.7.4	Continuous kilns	26
2.2.7.4.1	Chamber (Hoffmann) kilns	26
2.2.7.4.2	Tunnel kilns	26
2.2.7.4.3	Roller hearth kilns	27
2.2.7.4.4	Sliding bat kilns	28
2.2.7.5	Clamp firing	28
2.2.7.6	Rotary kilns	28
2.2.7.7	Fluidised beds	29
2.2.7.8	Cooling stage heat recovery	29
2.2.8	Subsequent treatment (product finishing)	29
2.2.8.1	Machining (grinding, drilling, sawing)	29
2.2.8.1.1	Wet grinding	29
2.2.8.1.2	Dry grinding	29
2.2.8.1.3	Drilling	29
2.2.8.1.4	Sawing	30
2.2.8.2	Polishing	30
2.2.8.3	Carbon enrichment (refractory products)	30
2.2.8.4	Tumbling of facing bricks	30
2.2.9	Addition of auxiliary materials	31
2.2.9.1	Jointing materials (pipes)	31
2.2.9.2	Silicones/water repellents	31
2.2.9.3	Insulation materials	31
2.2.9.4	Carding and plating (refractory bricks)	31
2.2.9.5	Adhesives	31
2.2.9.6	Final assembly	31
2.2.10	Sorting, packaging and storage	31
2.2.11	Supply and disposal (off-gas treatment and process waste water treatment) facilities	32
2.2.12	Recycling in the ceramic industry	32
2.2.13	General process flow diagram showing different processing paths	33
2.3	Description of techniques for the manufacture of ceramic products sector by sector	34
2.3.1	Bricks and roof tiles	34
2.3.1.1	Raw materials	35
2.3.1.2	Preparation of raw materials	39
2.3.1.3	Shaping	40
2.3.1.4	Drying, glazing and engobing	41
2.3.1.5	Firing	41
2.3.1.6	Subsequent treatment	43
2.3.1.7	Input and output flows in the manufacture of bricks and roof tiles	43
2.3.2	Vitrified clay pipes	44
2.3.2.1	Raw materials	45
2.3.2.2	Preparation of raw materials	47
2.3.2.3	Shaping	47
2.3.2.4	Drying and glazing	47
2.3.2.5	Firing	47
2.3.2.6	Subsequent treatment	48
2.3.2.7	Input and output flows in the manufacture of vitrified clay pipes	48
2.3.3	Refractory products	49
2.3.3.1	Raw materials	50
2.3.3.2	Preparation of raw materials	51
2.3.3.3	Shaping	51
2.3.3.4	Drying	52
2.3.3.5	Firing	52
2.3.3.6	Subsequent treatment	53

2.3.3.7	Special procedures	53
2.3.3.8	Input and output flows in the manufacture of refractory products	54
2.3.4	Expanded clay aggregates	54
2.3.4.1	Raw materials, additives and auxiliary agents	56
2.3.4.2	General system and process technology	57
2.3.4.2.1	Shaping	57
2.3.4.2.2	Thermal process technology	57
2.3.4.2.3	Chemical reaction during expansion	58
2.3.4.2.4	Subsequent sieving and crushing	58
2.3.4.3	Input and output flows in the manufacture of expanded clay aggregates	58
2.3.5	Wall and floor tiles	59
2.3.5.1	Raw materials	60
2.3.5.2	Preparation of raw materials	61
2.3.5.3	Shaping	61
2.3.5.4	Drying	62
2.3.5.5	Firing and glazing	62
2.3.5.6	Subsequent treatment	63
2.3.5.7	Input and output flows in the manufacture of wall and floor tiles	63
2.3.6	Table- and ornamentalware (household ceramics)	64
2.3.6.1	Raw materials	65
2.3.6.2	Preparation of raw materials	65
2.3.6.3	Shaping	66
2.3.6.4	Drying	67
2.3.6.5	Firing, glazing and decoration	67
2.3.6.6	Subsequent treatment	70
2.3.6.7	Input and output flows in the manufacture of household ceramics	70
2.3.7	Sanitaryware	71
2.3.7.1	Raw materials	71
2.3.7.2	Preparation of raw materials	72
2.3.7.3	Shaping	72
2.3.7.4	Drying and glazing	72
2.3.7.5	Firing	73
2.3.7.6	Subsequent treatment	74
2.3.7.7	Input and output flows in the manufacture of sanitaryware	74
2.3.8	Technical ceramics	75
2.3.8.1	Raw materials	76
2.3.8.2	Preparation of raw materials	77
2.3.8.3	Shaping	78
2.3.8.4	Machining	79
2.3.8.5	Glazing, engobing and metallisation	80
2.3.8.6	Drying, burning out and pre-firing	81
2.3.8.7	Firing/sintering	82
2.3.8.8	Subsequent treatment	83
2.3.8.9	Input and output flows in the manufacture of technical ceramics	83
2.3.9	Inorganic bonded abrasives	84
2.3.9.1	Raw materials	84
2.3.9.2	Preparation of raw materials	84
2.3.9.3	Shaping	85
2.3.9.4	Drying	85
2.3.9.5	Firing	85
2.3.9.6	Subsequent treatment	85
2.3.9.7	Input and output flows in the manufacture of inorganic bonded abrasives	85
3	CURRENT EMISSION AND CONSUMPTION LEVELS	87
3.1	Emissions – general considerations	87
3.1.1	Emissions to air	87
3.1.1.1	Dust (particulate matter)	87
3.1.1.2	Gaseous emissions	87
3.1.1.2.1	Sulphur dioxide and other sulphur compounds	87
3.1.1.2.2	Oxides of nitrogen and other nitrogen compounds	87
3.1.1.2.3	Carbon monoxide (and carbon dioxide)	88
3.1.1.2.4	Volatile organic compounds (VOCs)	88
3.1.1.2.5	Metals and their compounds	88

3.1.1.2.6	Chlorine and its compounds.....	88
3.1.1.2.7	Fluorine and its compounds.....	89
3.1.2	Emissions to water.....	89
3.1.3	Process losses/waste.....	90
3.1.4	Emissions of noise.....	90
3.1.5	Possible emission sources and emission paths.....	91
3.2	Consumption – general considerations.....	92
3.2.1	Energy consumption.....	92
3.2.2	Water consumption.....	92
3.2.3	Raw materials consumption.....	92
3.3	Presentation of emission and consumption data.....	93
3.3.1	Bricks and roof tiles.....	93
3.3.1.1	Emission data.....	93
3.3.1.2	Consumption data.....	102
3.3.2	Vitrified clay pipes.....	104
3.3.2.1	Emission data.....	104
3.3.2.2	Consumption data.....	106
3.3.3	Refractory products.....	107
3.3.3.1	Emission data.....	107
3.3.3.2	Consumption data.....	109
3.3.4	Expanded clay aggregates.....	111
3.3.4.1	Emission data.....	111
3.3.4.2	Consumption data.....	113
3.3.5	Wall and floor tiles.....	114
3.3.5.1	Emission data.....	114
3.3.5.2	Consumption data.....	118
3.3.6	Table- and ornamentalware (household ceramics).....	119
3.3.6.1	Emission data.....	119
3.3.6.2	Consumption data.....	123
3.3.7	Sanitaryware.....	124
3.3.7.1	Emission data.....	124
3.3.7.2	Consumption data.....	127
3.3.8	Technical ceramics.....	128
3.3.8.1	Emission data.....	128
3.3.8.2	Consumption data.....	131
3.3.9	Inorganic bonded abrasives.....	132
3.3.9.1	Emission data.....	132
3.3.9.2	Consumption data.....	134
4	TECHNIQUES TO CONSIDER IN THE DETERMINATION OF BAT FOR CERAMIC MANUFACTURING.....	135
4.1	Reduction of energy consumption (energy efficiency).....	136
4.1.1	Improved design of kilns and dryers.....	136
4.1.2	Recovery of excess heat from kilns.....	138
4.1.3	Cogeneration/combined heat and power plants.....	139
4.1.4	Substitution of heavy fuel oil and solid fuels by low emission fuels.....	141
4.1.5	Modification of ceramic bodies.....	142
4.2	Emissions of dust (particulate matter).....	144
4.2.1	Measures for dusty operations.....	144
4.2.2	Measures for bulk storage areas.....	145
4.2.3	Separation/filter systems.....	146
4.2.3.1	Centrifugal separators.....	146
4.2.3.2	Bag filters.....	146
4.2.3.3	Sintered lamellar filters.....	149
4.2.3.4	Wet dust separators.....	150
4.2.3.5	Electrostatic precipitators (ESP).....	151
4.3	Gaseous compounds.....	153
4.3.1	Reducing the input of pollutant precursors.....	153
4.3.2	Addition of calcium rich additives.....	155
4.3.3	Process optimisation.....	157
4.3.3.1	Optimising the heating curve.....	157
4.3.3.2	Reduction of water vapour levels in the kiln gases.....	159
4.3.3.3	Internal carbonisation gas combustion.....	159

4.3.3.4	Low-NO _x burners	161
4.3.4	Sorption plants (adsorbers, absorbers)	162
4.3.4.1	Cascade-type packed bed adsorbers	162
4.3.4.2	Module adsorber systems	165
4.3.4.3	Dry flue-gas cleaning with a filter (bag filter or electrostatic precipitator)	167
4.3.4.4	Wet flue-gas cleaning	169
4.3.4.5	Activated carbon filters	171
4.3.4.6	Biological scrubbers	172
4.3.5	Afterburning	172
4.3.5.1	Thermal afterburning	173
4.3.5.2	Catalytic afterburning	175
4.3.6	Examples of operational data, efficiencies, consumption and cost data for different flue-gas cleaning techniques	177
4.4	Process waste water	181
4.4.1	Water used as a raw material	181
4.4.2	Water used as a heat exchange vehicle	181
4.4.3	Water used as a scrubbing agent	181
4.4.4	Water used as a cleaning agent	181
4.4.5	Objectives and solutions for the reduction of process waste water (emissions and consumption)	181
4.4.5.1	Process optimisation	182
4.4.5.2	Systems of process waste water treatment	183
4.5	Process losses/waste	185
4.5.1	Sludge arising in the manufacture of ceramic products	185
4.5.1.1	Sludge recycling systems	185
4.5.1.2	Sludge re-use in other products	187
4.5.2	Solid process losses/solid waste	188
4.5.2.1	General considerations concerning re-use of solid process losses as raw materials	188
4.5.2.2	General considerations on plaster moulds, firing auxiliaries and broken ware – avoidance/replacement/reduction	189
4.6	General considerations concerning noise	190
4.7	Environmental management tools	191
5	BEST AVAILABLE TECHNIQUES FOR CERAMIC MANUFACTURING	199
5.1	Generic Best Available Techniques	201
5.1.1	Environmental management	201
5.1.2	Energy consumption	202
5.1.3	Dust emissions	203
5.1.3.1	Diffuse dust emissions	203
5.1.3.2	Channelled dust emissions from dusty operations	203
5.1.3.3	Dust emissions from drying processes	203
5.1.3.4	Dust emissions from kiln firing processes	203
5.1.4	Gaseous compounds	204
5.1.4.1	Primary measures/techniques	204
5.1.4.2	Secondary measures/techniques and in combination with primary measures/techniques	204
5.1.5	Process waste water (emissions and consumption)	205
5.1.6	Sludge	206
5.1.7	Solid process losses/solid waste	206
5.1.8	Noise	206
5.2	Sector specific Best Available Techniques	207
5.2.1	Bricks and roof tiles	207
5.2.1.1	Gaseous compounds/primary measures/techniques	207
5.2.1.2	Volatile organic compounds	207
5.2.2	Vitrified clay pipes	207
5.2.2.1	Channelled dust emissions	207
5.2.3	Refractory products	207
5.2.3.1	Volatile organic compounds	207
5.2.3.2	Solid process losses/solid waste	208
5.2.4	Expanded clay aggregates	208
5.2.4.1	Channelled dust emissions	208
5.2.4.2	Gaseous compounds/primary measures/techniques	208

5.2.5	Wall and floor tiles	208
5.2.5.1	Channelled dust emissions.....	208
5.2.5.2	Dust emissions from kiln firing processes	208
5.2.5.3	Gaseous compounds/secondary measures/techniques	209
5.2.5.4	Re-use of process waste water	209
5.2.5.5	Re-use of sludge	209
5.2.6	Table- and ornamental ware (household ceramics)	209
5.2.6.1	Channelled dust emissions.....	209
5.2.6.2	Gaseous compounds/secondary measures/techniques	209
5.2.6.3	Re-use of process waste water	209
5.2.6.4	Solid process losses/solid waste	210
5.2.7	Sanitaryware	210
5.2.7.1	Channelled dust emissions.....	210
5.2.7.2	Gaseous compounds/secondary measures/techniques	210
5.2.7.3	Re-use of process waste water	210
5.2.7.4	Solid process losses/solid waste	210
5.2.8	Technical ceramics	210
5.2.8.1	Channelled dust emissions.....	210
5.2.8.2	Gaseous compounds/secondary measures/techniques	211
5.2.8.3	Volatile organic compounds	211
5.2.8.4	Solid process losses/solid waste	211
5.2.9	Inorganic bonded abrasives	211
5.2.9.1	Volatile organic compounds	211
6	EMERGING TECHNIQUES FOR CERAMIC MANUFACTURING.....	213
6.1	Radiant tube burners	213
6.2	Microwave assisted firing and microwave dryers.....	213
6.3	New type of drying system for refractory products	214
6.4	Advanced process waste water management with integrated glaze recovery	216
6.5	Lead-free glazing of high quality table porcelain	217
7	CONCLUDING REMARKS.....	219
8	REFERENCES	223
9	GLOSSARY	225

List of figures

Figure 1.1: Stages in the manufacture of ceramic products.....	2
Figure 2.1: Ranges of industrial maturing temperatures for different product groups	25
Figure 2.2: Cross-section of a shuttle kiln.....	26
Figure 2.3: Schematic view of a tunnel kiln.....	27
Figure 2.4: Cross-section of a tunnel kiln with a tunnel kiln car.....	27
Figure 2.5: Cross-section of a roller hearth kiln.....	28
Figure 2.6: General process flow diagram showing different processing paths.....	33
Figure 2.7: Schematic view of pressed roof tile manufacture	34
Figure 2.8: Schematic view of preparation of extruded bricks in masonry brick manufacture	35
Figure 2.9: Distribution of fluoride content in Italian clays.....	37
Figure 2.10: Distribution of chlorine content in Italian clays.....	38
Figure 2.11: Distribution of sulphur content in Italian clays.....	38
Figure 2.12: Sulphur content in clays.....	39
Figure 2.13: Input and output flows in the manufacture of bricks and roof tiles	44
Figure 2.14: Schematic view of the manufacture of vitrified clay pipes.....	45
Figure 2.15: Input and output flows in the manufacture of vitrified clay pipes	49
Figure 2.16: Schematic view of the manufacture of basic bricks containing chromium ore.....	50
Figure 2.17: Input and output flows in the manufacture of refractory products.....	54
Figure 2.18: Schematic view of the manufacture of expanded clay aggregates.....	55
Figure 2.19: Input and output flows in the manufacture of expanded clay aggregates	59
Figure 2.20: Schematic view of wall and floor tile manufacturing.....	60
Figure 2.21: Input and output flows in the manufacture of wall and floor tiles	63
Figure 2.22: Schematic view of the manufacture of table porcelain	64
Figure 2.23: Input and output flows in the manufacture of household ceramics.....	70
Figure 2.24: Schematic view of the manufacture of sanitaryware	71
Figure 2.25: Input and output flows in the manufacture of sanitaryware.....	74
Figure 2.26: Schematic view of an electrical insulator manufacturing process	75
Figure 2.27: Schematic view of a ceramic catalyst manufacturing process.....	76
Figure 2.28: Green, white and hard machining in the manufacture of technical ceramics.....	80
Figure 2.29: Input and output flows in the manufacture of technical ceramics.....	83
Figure 2.30: Input and output flows in the manufacture of inorganic bonded abrasives.....	86
Figure 3.1: Distribution of released fluoride in the Italian brick and roof tile industry.....	95
Figure 3.2: Distribution of released chloride in the Italian brick and roof tile industry	95
Figure 3.3: SO _x emissions in Germany, United Kingdom and Belgium.....	96
Figure 3.4: Mass flow example for the manufacture of masonry bricks	104
Figure 3.5: Mass flow example for the manufacture of vitrified clay pipes.....	107
Figure 3.6: Mass flow example for the manufacture of periclase chromite bricks.....	110
Figure 3.7: Mass flow example for the manufacture of tableware.....	124
Figure 3.8: Mass flow example for the manufacture of sanitaryware	128
Figure 4.1: Schematic view of an example of a combined heat recycling system	138
Figure 4.2: Schematic view of hot air generation using a cogeneration gas engine.....	140
Figure 4.3: Schematic view of a bag filter with pressure pulse regeneration.....	147
Figure 4.4: Investment cost examples as part of annual costs for filter plants excluding installation and filter bags	148
Figure 4.5: Schematic view of a rigid sintered lamellar filter	149
Figure 4.6: Temperature ranges of a temperature curve example for the release of pollutants during the firing of bricks	158
Figure 4.7: Schematic view of internal carbonisation gas combustion	160
Figure 4.8: Illustration of a crossflow cascade adsorber	162
Figure 4.9: Process diagram of a cascade-type packed bed adsorber with peeling drum.....	163
Figure 4.10: Schematic view of a honeycomb module adsorber system.....	166
Figure 4.11: Schematic view of dry flue-gas cleaning with a bag filter.....	167
Figure 4.12: Schematic view of dry flue-gas cleaning with an electrostatic precipitator.....	168
Figure 4.13: Illustration of a wet flue-gas cleaning unit.....	170
Figure 4.14: Schematic view of a thermal afterburning system in a thermoreactor (three-chamber system)	174
Figure 4.15: Flue-gas conduction in an external thermal afterburning system	174
Figure 4.16: Flow diagram of a process waste water purification plant.....	184
Figure 4.17: Schematic view of a sludge recycling installation	186

List of tables

Table 1.1: Ceramics output, sales and employment figures.....	3
Table 1.2: Specific energy consumption in the ceramics industry in Europe	4
Table 1.3: Share of used fuels in Germany per sector in 1998	5
Table 1.4: The vitrified clay pipes industry in Europe.....	7
Table 1.5: EU-15 manufacture of refractory products in 2001/2002.....	8
Table 1.6: Simplified classification of ceramic tiles.....	10
Table 1.7: Energy consumption per Member State (specific energy consumption in TJ per 1000 tonnes produced)	10
Table 1.8: Output of table- and ornamentalware	11
Table 2.1: Ranges of chemical and mineralogical compositions of clay raw materials applied in the brick and roof tile industry in different European countries.....	36
Table 2.2: Operating data of tunnel kilns.....	42
Table 2.3: Comparison of classic tunnel kilns and fast firing methods (roof tiles).....	42
Table 2.4: Operating data of fast firing tunnel kilns	42
Table 2.5: Mineralogical composition of clay in the manufacture of vitrified clay pipes	46
Table 2.6: Chemical composition of clay in the manufacture of vitrified clay pipes	46
Table 2.7: Ranges of operating data of tunnel kilns	48
Table 2.8: Most used oxides in melting/casting operations	51
Table 2.9: Operating data of periodically operated dryers (chamber dryers).....	52
Table 2.10: Operating data of two tunnel dryers and a climate controlled dryer.....	52
Table 2.11: Operating data of tunnel kilns used in the refractory industry.....	53
Table 2.12: Operating data of shuttle kilns.....	53
Table 2.13: Examples of expansion promoting additives and auxiliary agents	56
Table 2.14: Operating data of tunnel kilns and roller hearth kilns.....	62
Table 2.15: Typical ranges of the mineralogical composition of raw materials for the manufacture of household ceramics	65
Table 2.16: Typical ranges of the chemical composition of raw materials for the manufacture of household ceramics	65
Table 2.17: Operating data of a shuttle kiln.....	68
Table 2.18: Operating data of tunnel kilns.....	68
Table 2.19: On-glaze decoration operating data	69
Table 2.20: In-glaze and under-glaze decoration operating data	69
Table 2.21: Operating data of periodically operated dryers (chamber dryers).....	73
Table 2.22: Operating data of tunnel kilns.....	73
Table 2.23: Operating data of shuttle kilns.....	73
Table 2.24: Sintering temperatures for technical ceramic materials.....	82
Table 3.1: Overview on possible emission sources and emission paths in the ceramic industry.....	91
Table 3.2: Emission ranges of raw flue-gases from the firing process of brick and roof tiles manufacturing	94
Table 3.3: Operating data of raw gas with various fuels.....	96
Table 3.4: Raw gas values with various pore-forming agents	97
Table 3.5: Average clean gas concentrations (porous clay blocks) and corresponding product related emission factors.....	97
Table 3.6: Clean gas concentrations of masonry brick plants.....	98
Table 3.7: Clean gas concentrations of clinker brick plants and roof tile plants.....	99
Table 3.8: Raw gas and clean gas emission values in clay block manufacturing	100
Table 3.9: Raw gas and clean gas emission values in facing brick manufacturing.....	101
Table 3.10: Energy consumption data per tonne of product from installations for the manufacture of bricks and roof tiles.....	102
Table 3.11: Specific energy consumption in the brick and roof tile industry	103
Table 3.12: Maximum concentration of clean gas in the manufacture of vitrified clay pipes	105
Table 3.13: Specific energy consumption in the manufacture of vitrified clay pipes	106
Table 3.14: Raw gas values of different refractory products	108
Table 3.15: Emissions from kilns for non-basic refractory products.....	108
Table 3.16: Raw gas values for special procedures	108
Table 3.17: Energy consumption data for the manufacture of magnesia refractory bricks, regarding kg of product	109
Table 3.18: Ranges of dust emission values from primary crushing downstream of a fabric filter.....	111
Table 3.19: Ranges of actual emission values from dry grinding downstream of the respective filter system.....	111
Table 3.20: Ranges of dust emission values from granulation downstream of a fabric filter	112

Table 3.21: Ranges of emission values from firing processes downstream of the respective filter systems	112
Table 3.22: Dust emission values of screening units.....	112
Table 3.23: Effluent values of wet scrubbers	113
Table 3.24: Raw material mix in the production of expanded clay aggregates.....	113
Table 3.25: Operating data and raw gas values of spray drying units	114
Table 3.26: Operating data and raw gas values of dryers.....	115
Table 3.27: Operating data and raw gas values in firing	115
Table 3.28: Gaseous emissions from the various phases of wall and floor tile manufacturing processes. Pollutant emission factors for uncontrolled (UC) and controlled (C) emissions	116
Table 3.29: Chemical analysis of untreated process waste water.....	117
Table 3.30: Ranges of the main chemical components of sludge (manufacture of wall and floor tiles)..	117
Table 3.31: Examples of specific energy requirements of different kilns	118
Table 3.32: Comparison of the specific consumption of thermal energy and electrical energy per process step.....	118
Table 3.33: Operating data and clean gas dust emission values of a spray dryer.....	119
Table 3.34: Raw gas values and operating data in household ceramics firing	120
Table 3.35: Raw and clean gas values of a one time firing process of household ceramics	120
Table 3.36: Ceramic pigment systems used for decoration colours	121
Table 3.37: Concentrations of heavy metals in the raw gas of decoration firing	121
Table 3.38: Process waste water analysis of a porcelain tableware manufacturer	122
Table 3.39: Process waste water analysis of a household ceramics plant	122
Table 3.40: Thermal and electrical energy consumption data of a porcelain tableware manufacturer	123
Table 3.41: Example of raw and clean gas compositions from one tunnel kiln	125
Table 3.42: Raw gas concentrations of tunnel and shuttle kilns.....	125
Table 3.43: Examples of clean gas concentrations of two sanitaryware plants.....	126
Table 3.44: Pollutant concentrations in cleaned process waste water	126
Table 3.45: Operating data and throughput of different kilns	127
Table 3.46: Energy consumption data	127
Table 3.47: Raw gas concentrations in the firing of electrical insulators.....	129
Table 3.48: Flue-gas concentrations from a shuttle kiln during the firing of electrical insulators	129
Table 3.49: Concentrations in cleaned process waste water from an electrical insulator manufacturer...	130
Table 3.50: Concentrations in process waste water from an electric insulator manufacturer after flocculation	130
Table 3.51: Concentrations in cleaned process waste water from a manufacturer of piezoceramic products	131
Table 3.52: Energy consumption data from two electroporcelain plants	131
Table 3.53: Raw material compositions for the manufacture of electroporcelain.....	132
Table 3.54: Examples of flue-gas values from three plants in which inorganic bonded abrasives are manufactured	133
Table 3.55: Overall energy consumption data from three inorganic bonded abrasives manufacturers....	134
Table 3.56: Raw material consumption data from three inorganic bonded abrasives manufacturers	134
Table 4.1: Information breakdown for each technique described in this chapter	135
Table 4.2 Examples of temperature resistance and the price of filter bags	148
Table 4.3: Examples of operating data for dust removal with fabric filters	148
Table 4.4: Operating and cost data for electrostatic precipitators	152
Table 4.5: Technical parameters, efficiencies, consumption and cost data for flue-gas cleaning techniques	177
Table 4.6: Reduction efficiencies regarding the dependency of the sulphur content in the raw material	178
Table 4.7: Costs regarding the abatement of dust, inorganic gaseous compounds and organic gaseous compounds by using different abatement techniques	180
Table 4.8: Achievable process waste water recycling ratios in different sectors of the ceramic industry	182
Table 5.1: BAT associated emission levels for gaseous inorganic compounds from flue-gases of kiln firing processes	205
Table 5.2: BAT associated emission levels of pollutants in waste water discharges	205
Table 7.1: Timing of the work process on the BREF on Ceramic Manufacturing	219

SCOPE

This document addresses the industrial activities specified in Section 3.5 of Annex I of Directive 96/61/EC, namely:

‘3.5. Installations for the manufacture of ceramic products by firing, in particular roofing tiles, bricks, refractory bricks, tiles, stoneware or porcelain, with a production capacity exceeding 75 tonnes per day, and/or with a kiln capacity exceeding 4 m³ and with a setting density per kiln exceeding 300 kg/m³’.

For the purposes of this document the industrial activities falling within this description will be referred to as the ceramic industry.

The various sectors of the ceramic industry encompass a wide range of raw materials and manufacturing techniques, but all involve the selection of clays or other mainly inorganic materials which are processed then dried and fired. The major sectors which are based on the ceramic products (ceramics) manufactured are as follows:

- wall and floor tiles
- bricks and roof tiles
- table- and ornamentalware (household ceramics)
- refractory products
- sanitaryware
- technical ceramics
- vitrified clay pipes
- expanded clay aggregates
- inorganic bonded abrasives.

In addition to the basic manufacturing activities, this document covers the directly associated activities which could have an effect on emissions or pollution. Thus, this document includes activities from the preparation of raw materials to the dispatch of finished products. Certain activities are not covered, because they are not considered to be directly associated with the primary activity. For example, the quarrying of raw materials is not covered. The activities that are covered include:

- selection and preparation of raw materials – mainly based on clays and/or other inorganic minerals
- shaping of ware – usually from raw materials which are in the plastic state
- drying of the ware and possibly coating
- kiln firing to achieve vitrification
- subsequent treatment and packaging.

1 GENERAL INFORMATION ON CERAMIC MANUFACTURING

1.1 Historical origins

The term 'ceramics' is derived from the Greek 'keramos' meaning 'burned earth' and is used to describe materials of the pottery industry. Recent research shows that the processing of clay started around 19000 BC. The oldest findings of pottery in southern Japan are dated between 8000 BC and 9000 BC. As early as 4000 BC fired bricks were used for the construction of temple towers, palaces and fortifications. More than 2000 years ago the Romans spread the technique of brick making into large parts of Europe. In Egypt, glazed ceramic plates were used as wall decorations for the pyramids in 2600 BC and in China, the art of china porcelain making has been known since 1000 BC.

1.2 Characteristics of ceramics

Generally the term 'ceramics' (ceramic products) is used for inorganic materials (with possibly some organic content), made up of non-metallic compounds and made permanent by a firing process. In addition to clay based materials, today ceramics include a multitude of products with a small fraction of clay or none at all. Ceramics can be glazed or unglazed, porous or vitrified.

Firing of ceramic bodies induces time-temperature transformation of the constituent minerals, usually into a mixture of new minerals and glassy phases. Characteristic properties of ceramic products include high strength, wear resistance, long service life, chemical inertness and non-toxicity, resistance to heat and fire, (usually) electrical resistance and sometimes also a specific porosity.

The main steps in the manufacture of ceramic products are largely independent of the materials used and the final product. The following figure schematically shows the typical process and possible or necessary supply and disposal facilities. The process is made up of the steps: mining/quarrying of raw materials and transport to the ceramic plant (neither of these two steps is covered in this document), storage of raw materials, preparation of raw materials, shaping, drying, surface treatment, firing and subsequent treatment [23, TWG Ceramics, 2005].

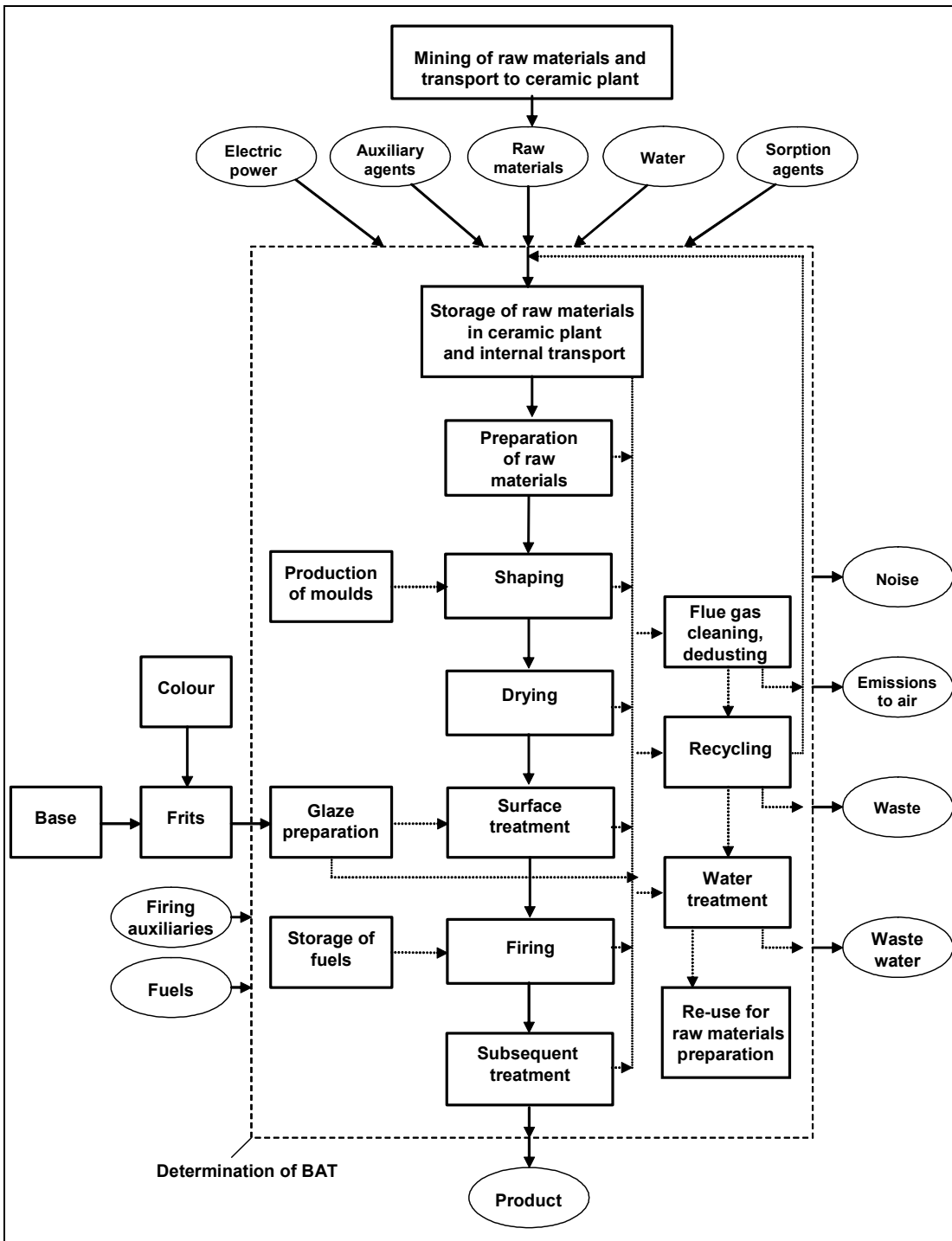

Figure 1.1: Stages in the manufacture of ceramic products

The best available techniques for integrated environmental protection in the ceramic industry named in this document are related to the processes employed within the bordered area.

1.3 Geographical distribution and general economic considerations

Clay raw materials are widely distributed throughout Europe, so ceramic products like bricks which are relatively inexpensive (but which incur high transport costs due to their weight) are manufactured in virtually all Member States. Building traditions and heritage considerations result in different unit sizes from country to country. More specialised products which command higher prices tend to be mainly produced in a few countries, which have the necessary special raw materials and – equally important – traditions of skill and expertise. For example, a large percentage of ceramic tiles are manufactured in Italy and Spain; tableware in the United Kingdom, Germany and France; vitrified clay pipes in Germany, United Kingdom, Belgium and the Netherlands.

There is considerable international trade in wall and floor tiles, refractory products, table- and ornamentalware, technical ceramics, vitrified clay pipes and sanitaryware.

The importance of the ceramic industry in terms of employment and economics is shown in the following table [20, CERAME-UNIE, 2004], [23, TWG Ceramics, 2005], [26, UBA, 2005], [30, TWG Ceramics, 2005].

Sector of Ceramic industry	EU-15 Output 2000 (x million tonnes)	EU-15 sales 2003 (x million EUR)	Manpower 2003 (x 1000)
Wall and floor tiles	25.0	10100	69
Bricks and roof tiles	55.0	6800	50
Table- and ornamentalware	0.5	2000	48
Refractory products	4.5	3100	18
Sanitaryware	0.5	1900	25
Technical ceramics	0.15	2000	9
Vitrified clay pipes	0.7	300	2
Expanded clay aggregates (2002)	3.0	300	2.5
Inorganic bonded abrasives (2003)	0.04	260	3.1

Table 1.1: Ceramics output, sales and employment figures

1.4 Key environmental issues

Depending on the specific production processes, plants making ceramic products cause emissions to be released into air, water and land (waste). Additionally, the environment can be affected by noise and unpleasant smells. The type and quantity of air pollution, wastes and waste water depend on different parameters. These parameters are, e.g. the raw materials used, the auxiliary agents employed, the fuels used and the production methods:

- emissions to air: particulate matter/dust can arise from the handling or processing of raw materials or product finishing and also soot can arise from firing fuel oil or different solid fuels. Gaseous emissions arise during the firing or spray-drying of ceramics and may be derived from the raw materials and/or from the fuels employed. Carbon oxides, nitrogen oxides, sulphur oxides, inorganic fluorine and chlorine compounds, as well as organic compounds are of particular importance among the gaseous emissions. Due to the use of substances for decorative purposes which contain heavy metals, or due to the usage of heavy oil as fuel, heavy metals can also be emitted
- emissions to water: these mainly occur during the manufacturing processes of ceramic products, especially during the manufacture of traditional ceramics, and the resulting process waste water mainly contains mineral components (insoluble particulate matter). Depending on the production method, the process waste water also contains further inorganic materials, small quantities of numerous organic materials as well as some heavy metals. Apart from process water, which often is cleaned and re-used in closed circuits, also cooling water, rainwater and sanitary waste water may contribute to the emission to water from the plant
- process losses/waste: process losses originating from the manufacture of ceramic products, mainly consist of the following materials:
 - different kinds of sludge (sludge from process waste water treatment, glazing sludge, plaster sludge, grinding sludge)
 - broken ware from shaping, drying, firing and refractory material
 - dust from flue-gas cleaning and dedusting units
 - used plaster moulds
 - used sorption agents (granular limestone, limestone dust)
 - packaging waste (plastic, wood, metal, paper, etc.)
 - solid residues, e.g. ashes arise from firing with solid fuels.

Parts of the accumulated process losses mentioned above, can be recycled and re-used within the plant due to product specifications or process requirements. Materials, which cannot be recycled internally, leave the plant as waste and are supplied to external recycling or disposal facilities.

- energy consumption/CO₂ emissions: all sectors of the ceramic industry are energy intensive, as a key part of the process involves drying followed by firing to temperatures of between 800 and 2000 °C. For the manufacture of porcelain, energy accounts for between less than 10 to 18 % of the total costs. For the manufacture of bricks, the share of the energy costs varies between 17 and 25 % with maximum levels of up to 30 %.

The following table shows the specific energy consumption in the ceramics industry in Europe [30, TWG Ceramics, 2005]:

Sector	Unit	1980	1985	1990	1995	2000	2003
Brick and roof tiles	GJ/t	2.65	2.45	2.19	2.06	2.38	2.31
Wall and floor tiles	GJ/t	11.78	9.16	6.76	5.45	5.74	5.60
Refractory products	GJ/t	4.88	4.96	6.51	4.91	5.41	5.57
Sanitaryware	GJ/t	26.56	24.214	22.27	22.76	20.88	21.87
Vitrified clay pipes	GJ/t			5.75	5.77	6.1	5.23
Table- and ornamentalware	GJ/t			47.56	38.91	43.46	45.18
Technical ceramics	GJ/t					34.72	50.39

Table 1.2: Specific energy consumption in the ceramics industry in Europe

Today natural gas, liquefied petroleum gas (propane and butane) and fuel oil EL are mainly used for firing, while heavy fuel oil, liquefied natural gas (LNG), biogas/biomass, electricity and solid fuels (e.g. coal, petroleum coke) can also play a role as energy sources for burners. The use of heavy fuel oil, coal and petroleum coke is limited mainly to brickworks.

In the following table the share of the different fuels in the total fuel consumption (without electricity) in Germany is listed according to the different sectors [4, UBA, 2001], [30, TWG Ceramics, 2005].

Sector	Natural gas (%)	Fuel oil EL (%)	Heavy fuel oil (%)	Other (%)
Household ceramics	98.0	1.6	-	0.4
Sanitaryware	97.7	2.3	-	-
Technical ceramics	96.2	3.6	-	0.2
Refractory products	90.2	7.3	0.1	2.4
Wall and floor tiles	98.1	1.1	0.8	-
Bricks and roof tiles	88.6	5.3	5.3	0.8
Vitrified clay pipes	100	-	-	-
Expanded clay aggregates ¹⁾	-	-	-	-
Inorganic bonded abrasives ²⁾	90.6	9.4	-	-
¹⁾ no data available				
²⁾ VDI estimated values for Germany				

Table 1.3: Share of used fuels in Germany per sector in 1998

1.5 Ceramics sectors

The fundamental methods and steps in the production processes hardly differ in the manufacture of the various ceramic products, besides the fact that, for the manufacture of, e.g. wall and floor tiles, table- and ornamentalware (household ceramics), sanitaryware and also technical ceramics, often a multiple stage firing process is used. This is one historical reason why the various ceramics sectors can be summarised in two groups, the group of ‘coarse’ or ‘construction’ ceramics including the bricks and roof tiles, vitrified clay pipes, refractory products and expanded clay aggregates sectors and the group of ‘fine’ or ‘traditional and industrial ceramics’, including the wall and floor tiles, table- and ornamentalware, sanitaryware, technical ceramics and inorganic bonded abrasives sectors.

The technical realisation, however, can be very different, according to specific requirements of the products and the characteristics of the raw materials used. For example, there are various continuously operated (e.g. tunnel kilns) and periodically operated (e.g. shuttle kilns) kilns used for firing the same or different ceramic products.

Products of the 'fine' or 'traditional and industrial' ceramic industry differ from products of the 'coarse or construction' ceramic industry in principle in their texture. The border between 'fine' or 'traditional and industrial' and 'coarse' or 'construction' ceramics varies between equivalent particle diameters of 0.1 and 0.2 mm. 'Coarse' or 'construction' ceramic products show an inhomogeneity of more than 0.2 mm but the borderline between 'fine' or 'traditional and industrial' and 'coarse' or 'construction' ceramics is not really fixed today. For example, the processing technology for 'fine' or 'traditional and industrial' ceramics is used for the production of super refractory products. Therefore this document does not follow the above-mentioned distinction between the two groups, but only distinguishes between the following nine sectors of ceramic products [32, TWG Ceramics, 2006]:

- bricks and roof tiles
- vitrified clay pipes
- refractory products
- expanded clay aggregates
- wall and floor tiles
- table- and ornamental ware (household ceramics)
- sanitaryware
- technical ceramics
- inorganic bonded abrasives.

1.5.1 Bricks and roof tiles

Brick products are produced in large quantities, which are used as materials in numerous branches of building and contracting. For the most part, bricks and tiles are not designated according to the shaping technique used, but according to the intended application:

- building bricks (e.g. clay blocks, facing bricks, engineering bricks ('klinker bricks') and lightweight bricks)
- roof tiles (e.g. extruded tiles, pressed tiles)
- paving bricks
- chimney bricks (e.g. chimney pipes).

Due to the different techniques in manufacture, different types of brickyards have specialised in various groups of products, e.g. clay roof tile works and building bricks works.

In 2003, the European clay brick and roof tile industry had total sales of around EUR 6800 million and a labour force of around 50000 [20, CERAME-UNIE, 2004], [23, TWG Ceramics, 2005].

There are variations in the number of clay brick works, paving works and roof tile works as follows:

Italy has the highest amount of factories, i.e. 238 works, followed by Germany (183), Portugal (150), France (136) and the United Kingdom (134). Less than 70 factories are operational in other countries like the Netherlands (58), Belgium (40), Austria (30), Switzerland (27) and Denmark (26).

The average number of brick works per million inhabitants is as follows:

Portugal (1.5), Denmark (5.1), Italy (4.1), Belgium (4.0), Austria (3.8), Switzerland (3.7), the Netherlands (3.7), United Kingdom (2.3), France (2.3) and Germany (2.2).

A comparison of the data [3, CERAME-UNIE, 2003] related to inhabitants in the following countries (situation in 2001) indicates:

- roof tile production is high in France (0.89 m² per inhabitant) followed by Italy (0.61), Germany (0.54), Spain (0.5), Switzerland (0.48), Denmark (0.4) and Austria (0.28). In other countries, e.g. United Kingdom and Belgium, the production of roof tiles is much lower. Finland and Norway do not produce roof tiles
- bricks and blocks are manufactured in each country of EU-15. The highest production is recorded in Belgium (0.29 m³ per inhabitant), followed by Spain (0.28), Italy (0.26), Austria (0.24), Germany (0.17), Switzerland (0.08) and with lower values in the other countries.

Perforated units are important, e.g. in Austria (97 %), Germany (87 %); facing bricks in the Netherlands (94 %), United Kingdom (82 %) and Denmark (85 %). Hollow units are favoured in France (63 %) and Italy (62 %).

The average number of employees per factory varies between the different European States:

- United Kingdom (66)
- Belgium (44)
- France (39) and the Netherlands (38)
- Austria (35), Germany (34) and Italy (34)
- Switzerland (24) and Denmark (21).

1.5.2 Vitrified clay pipes

Vitrified clay pipes and fittings are used for drains and sewers, but also tanks for acids and products for stables. The annual production in 2000 in EU-15 amounted to 708000 tonnes [3, CERAME-UNIE, 2003] [4, UBA, 2001].

Production plants are situated in Belgium, Germany, Italy, Netherlands and the United Kingdom. Their products are delivered to all EU-15 Member States on the basis of a European Standard EN 295, which was ratified in 1991 and meanwhile implemented in all EU-15 and EFTA member states and in some other associated CEN Member States.

In this document, the term ‘pipes’ is used to include fittings which together are needed to form a pipeline for sewage transportation, buried in the ground.

The following table shows general information about the vitrified clay pipes industry in Europe, in the year 2000 [3, CERAME-UNIE, 2003], [30, TWG Ceramics, 2005].

Country	BE	DE	IT	NL	UK	EU-15
Number of inhabitants (10 ⁶)	10	82	57.5	15.7	58.5	
Number of plants *)	1	8	1	2	5	17
Annual sales of pipes and fittings (tonnes)	115000	208000	74000	102000	209000	708000
Total number of employees	250	500	150	213	800	1913
Average staff per plant	377	115	207	107	220	166
*) The plants may operate more than one kiln						

Table 1.4: The vitrified clay pipes industry in Europe

1.5.3 Refractory products

Refractory products are ceramic materials capable of withstanding temperatures above 1500 °C. Numerous refractory products in a wide variety of shapes and forms are used in many industrial applications of the steel, iron, cement, lime, glass, ceramic, aluminium, copper and petrochemicals industries, in incinerators, power plants, and house heating systems including night storage heater blocks. They are vital to high temperature processes and resist all types of stresses (mechanical, thermal, chemical) such as erosion, creeping deformation, corrosion and thermal shocks.

The resistance of refractory materials to high temperatures is defined so that their softening point is not less than 1500 °C. A classification of ‘refractory materials’ with a softening point of between 1500 and 1800 °C and ‘high refractory materials’ with a softening point of more than 1800 °C is commonly used [23, TWG Ceramics, 2005].

Initially based on using higher purity clays as raw materials, refractory manufacture is now based on the use of a great diversity of raw materials which can be both natural and synthetic. Many are imported from countries outside Europe.

The demand for refractory products is closely linked to the levels of production and investment occurring in the consuming industries. For instance, the quantity of refractory materials consumed per tonne of manufactured products such as steel or cement has greatly decreased over the past decade because of technical innovation and processes. Longer lifetimes for the linings of steelmaking furnaces or for casting ladles along with less time for their repair and maintenance, markedly improved the productivity for the industries which use them.

Refractory products are usually applied in industries that are major energy consumers like the metals, the cement, the petrochemical and the glass industries. As the quality of the lining of the furnaces is very important for the energy efficiency of their processes, the refractories industry has a considerable impact on the energy efficiency of these industries. The continuous improvement of refractory products leads – through better insulation and longer lifetimes of the lining – to a decreasing specific energy consumption of the operations of the consuming industries.

The manufacture of refractory products in the EU-15 is the most important worldwide with a total production in 2001 of 4.6 million tonnes (the German industry being the leader with an estimated total production of 1.5 million tonnes) corresponding to approximately EUR 3300 million in 2002. About 65 % of this amount relates to iron and steel production; 5 to 8 % to the production of cement, glass, ceramics and the rest to non-ferrous metallurgy, chemical, petrochemical, energy production and incineration. In 2002, the EU-15 industry was employing 18505 people [20, CERAME-UNIE, 2004], [12, CTCV, 2004].

The following table shows the EU-15 manufacture of refractory products for the year 2001/2002 [20, CERAME-UNIE, 2004], [21, Almeida, 2004].

Countries	2002 Total Production (10 ³ tonnes)
Austria (2001)	710
Benelux	n.a.
France	524
Germany	931
Greece (2001)	33
Italy	556
Nordic Countries (2001)	147
Portugal	23
Spain	417
United Kingdom	204

Table 1.5: EU-15 manufacture of refractory products in 2001/2002

1.5.4 Expanded clay aggregates

Expanded clay aggregates are porous ceramic products with a uniform pore structure of fine, closed cells and with a densely sintered, firm external skin. They are manufactured from raw materials containing clay minerals. The raw material is prepared, moulded and then subjected to a firing process at temperatures of between 1100 and 1300 °C, resulting in a significant increase in volume due to expansion.

The products can be manufactured in any quantity and with precisely adjustable grain size and characteristics to meet a wide range of technical requirements for numerous areas of application.

They are used as loose or cement bound material for the construction industry (for instance loose fillings, lightweight concrete, blocks and other prefabricated lightweight concrete components, structural lightweight concrete for on-site processing) and also loose material in garden and landscape design (e.g. embankment fillings in road construction, substrates for green roofs, filter and drainage fillings).

The diverse range of industrially produced lightweight aggregates (LWA) covers a wide spectrum of technical characteristics. Properties such as grain size, porosity, weight and grain strength can be controlled during the manufacturing processes. Aggregates with grain densities of between 0.15 and 1.7 kg/dm³ are available to suit a wide range of requirements and applications. These lightweight aggregates have excellent insulating characteristics. This is due to the large number of finely distributed pores inside the material. Thermal conductivity values for loose fills of industrially produced lightweight aggregates range from 0.07 to 0.18 W/(mK), depending on the grain size and density of the respective material. Standardised granulometry is described in EN 13055 – 1 and EN 13055 – 2.

In addition to expanded clay aggregates, industrially produced lightweight aggregates also include expanded slate and shale, bottom ash, sintered hard coal flue dust and expanded glass, but this document do not deal with these other product groups.

Manufacturers of expanded clay aggregates are to be found in Denmark, Germany, Sweden, Norway, Finland, Estonia, Belgium, Austria, Poland, Spain, Italy, Portugal and in the Czech Republic. In central and eastern Europe, expanded clay is usually known under the name 'keramzit'. The total plant capacity in Europe is estimated to be around 10 million cubic metres.

1.5.5 Wall and floor tiles

Ceramic tiles (see EN 14411) are thin slabs made from clays and/or other inorganic materials, generally used as coverings for floors and walls. Ceramic tiles are usually shaped by extrusion or dust pressing at room temperature, then dried and subsequently fired at temperatures sufficient to develop the required properties.

The most common tile shapes are squares and rectangles, but other polygonal shapes (hexagons, octagons, etc.) are also available. As for size, tile sides range from only a few centimetres (mosaics) to slabs with 60 – 100 cm sides. Thickness ranges from around 5 mm for wall tiles to over 25 mm for some extruded tiles.

There are several types of ceramic tiles available on the market: shaped through dust pressing or extrusion; with porous, compact or vitrified bodies; with white (whitish) or coloured (reddish) bodies; unglazed or glazed.

The types of ceramic tiles manufactured in the Member States are similar; however, they differ in some characteristics due to cultural, formal, functional, commercial or technical reasons. Therefore it is difficult to establish the equivalence between the different types of products and their designations in the different Member States.

To overcome this difficulty, a general classification of ceramic tiles has been adopted in European and International standardisation. According to EN 14411, ceramic tiles are divided into nine groups, according to their method of manufacture (shaping method) and their water absorption. Water absorption is associated with the porosity of the material: high water absorption means high porosity, while low water absorption is associated with a compact, vitrified structure.

This classification is assumed as general reference in this document. However, the nine groups specified do not reflect significant differences as far as the environmental aspects discussed in this document are concerned. Therefore, for the specific purpose of this document, the following simplified classifications, as shown in the following table, will be used [3, CERAME-UNIE, 2003]. Some ceramic tiles are not considered in this classification, because in total they represent a very minor part as their production process and characteristics are quite different, and no significant or useful information is available.

Class	Description/specification
A	Extruded tiles
Bla	Dust pressed tiles with impervious body
Bib-BII	Dust pressed tiles with compact body
BIII	Dust pressed tiles with porous body

Table 1.6: Simplified classification of ceramic tiles

Ceramic wall and floor tiles are important wall and floor covering products used in the building and housing industry and, therefore, the maintenance and renovation market is of special importance to these products. Other applications are, e.g. the use of tiles for external facades, swimming pools and public areas.

The European industry sells tiles worldwide, being by far the biggest exporter. A quarter of the European production is exported to countries outside the EU-15: the European industry takes a ¼ share of international trade in tiles. In 2001, the European industry sold close to 1400 million m² of tiles for a total value of EUR 10000 million. Around 71000 people were employed by the industry in that year [3, CERAME-UNIE, 2003]. An important part of the industry is concentrated in two regions: the Sassuolo region in Italy (Emilia-Romagna) and Castellón in Spain (Comunidad de Valencia).

For the manufacture of tiles, highly refined clays are being used, which in most cases can be obtained in Europe itself. In addition, a variety of substances are being used for glazing purposes. Energy can be considered as a raw material as well, as it transforms the clays into ceramics through firing. Energy sources used are mainly natural gas and electricity.

The following table shows the energy consumption per Member State [20, CERAME-UNIE, 2004], [21, Almeida, 2004].

Countries	1980	1990	1997	2001
DE				7.58
EL	11.61	8.68	8.1	
ES	15.78	7.00	5.49	5.78
FR	6.97	5.84	5.71	6.42
IT	11.22	6.19	5.12	5.48
NL	10.94	8.46	8.76	
PT			6.20	6.00
UK	18.05	13.15	11.33	

Table 1.7: Energy consumption per Member State (specific energy consumption in TJ per 1000 tonnes produced)

1.5.6 Table- and ornamentalware (household ceramics)

The manufacture of household ceramics covers tableware, artificial and fancy goods made of porcelain, earthenware and fine stoneware. Typical products are plates, dishes, cups, bowls, jugs and vases.

The total production is small compared with other major industrial ceramic products, see Table 1.1. Tableware and ornamentalware have a completely different value to weight ratio.

Table- and ornamentalware conform to the general description of processes which apply to all ceramics. The following table summarises the output of the different wares [20, CERAME-UNIE, 2004], [21, Almeida, 2004].

Countries	Wares	Tonnes per year
Germany	Tableware from porcelain	69000
	other tableware	4000
	ornamentalware	estimated 500
Luxembourg	Total tableware	5370
The Netherlands	Tableware (earthenware, china, vitrified hotelware)	5500
	ornamentalware	250
Portugal	Total tableware and ornamental ware	90000
United Kingdom (2001)	Total tableware and ornamentalware	86000

Table 1.8: Output of table- and ornamentalware

1.5.7 Sanitaryware

Ceramic goods used for sanitary purposes are all included under the collective name sanitaryware. Typical sanitary ceramic products are lavatory bowls, bidets, wash basins, cisterns and drinking fountains. These products are mainly made of vitreous china (semi-porcelain) or earthenware.

The total production is small compared with other major industrial ceramic products, e.g. bricks or refractory products, see Table 1.1. Sanitaryware has a completely different value to weight ratio than bricks or refractory products.

The manufacture of sanitaryware follows processes similar to those which apply to all the other ceramic products. The raw materials are mixed with water to produce a clay slip of the required characteristics. The clay slip is then stored in tanks and used for slip casting in separate moulds or in pressure casting machines. The product is produced directly from the pressure casting machines or is released from the moulds used for the slip casting process. Pieces must be dried before they can be worked further, or transported.

Glazing is applied directly to the clay surface and fired at the appropriate temperature of the product concerned; normally between approximately 1200 – 1210 °C for vitreous china and at about 1220 °C for fireclay.

Spraying of the glaze provides the colour and ‘vibrancy’ to the underlying shape. The colour or colour combinations required are achieved by using pigments in association with the glaze. The majority of pigments are metal oxides. The quantities of pigments used are minimal compared with the weight of raw materials (clays) and other constituents.

The finished product enters the warehouse or storage facility for selection, dispatch and distribution.

1.5.8 Technical ceramics

The European manufacturers of technical ceramics produce a great variety of products, which at least in part are based on clays, but also on synthetic raw materials. Like in the other ceramic sectors, the raw materials are fired in kilns, using mainly natural gas, but also electricity (2003: approx. 2/3 gas and 1/3 electricity), in the process.

Technical ceramics are applied in many industries and cover both, established products like insulators and new applications. They supply elements for the aerospace and automotive industries (engine parts, catalyst carriers), electronics (capacitors, piezo-electrics), biomedical products (bone replacement), environment protection (filters) and many others.

Important manufacturers of technical ceramics are to be found in Germany, the United Kingdom, France and the Netherlands.

Due to the high added value of some products of technical ceramics, parts of this industry are not so highly energy intensive in relation to the turnover than other sectors. Relative to the mass, the consumption of energy is comparable. The European industry had an estimated total sales level of EUR 2500 million in 2001. While no precise data are available on total production in volume they were estimated to be at around 0.15 million tonnes in 2003 for the whole European industry [3, CERAME-UNIE, 2003] [23, TWG Ceramics, 2005].

1.5.9 Inorganic bonded abrasives

A principal characteristic of grinding – one of the oldest known production processes – is the effect of numerous, not orientated cutting materials in the workpiece. Abrasive products, which apply this principal characteristic, are tools widely used in working every kind of materials: not only grinding, but also cutting-off, polishing, dressing, sharpening, etc. for metals, plastics, wood, glass, stones etc.

Basically, a distinction can be made between bonded abrasives ('grinding wheels') and coated abrasives ('abrasive paper and tissues'). Furthermore, loose abrasives exist, which do not have any solid linkage to a backing (e.g. polishing pastes). This document only deals with 'inorganic bonded abrasives', a subgroup of the bonded abrasives.

An inorganic bonded abrasive (or 'vitrified bonded grinding wheel' as manufacturers say) is a tool where a synthetic abrasive – contemporary abrasive materials are special fused alumina, synthetic corundum, silicon carbide, cubic boron nitride (CBN) or diamond, pre-screened in uniform grit size – is blended with a vitrified bond (the normal ratio by weight is nine parts of abrasive to one part of body).

Then the product is fired at a temperature at which the body (e.g. glass, clay), that constitutes the bonding element, vitrifies and, after cooling down, binds together the abrasive grains [14, UBA, 2004], [23, TWG Ceramics, 2005], [30, TWG Ceramics, 2005].

2 APPLIED PROCESSES AND TECHNIQUES IN CERAMIC MANUFACTURING

2.1 Raw materials

A wide range of materials is employed by the ceramic industry to match the diversity of its product range. Both natural and synthetic materials are used, many produced within Europe but a few are imported. Sectoral needs are different and details of raw materials are listed in the chapters regarding the different sectors.

Formulas (or bodies) of clay based ceramics may consist of one single clay or more clays, mixed with mineral modifiers, so-called 'non-plastics', such as powdered quartz and feldspar.

Common clay minerals ('plastic clays') are hydrated aluminium silicates that have resulted from the weathering of rocks and there are two structural units involved in most clay mineral lattices. One is the 'silica sheet' formed of tetrahedra consisting of a Si^{4+} surrounded by four oxygen ions. The other structural unit is the 'aluminium hydroxide or gibbsite sheet', consisting of octahedra in which an Al^{3+} ion is surrounded by six hydroxyl groups. These octahedral sheets condense with the silica sheets to form the clay minerals.

There are a number of mineral species called clay minerals, but the most important are 'kaolinite', $\text{Al}_2\text{O}_3 \cdot 2\text{SiO}_2 \cdot 2\text{H}_2\text{O}$, 'montmorillonite', $\text{Al}_2\text{O}_3 \cdot 4\text{SiO}_2 \cdot \text{H}_2\text{O}$ and 'halloysite', $\text{Al}_2\text{O}_3 \cdot 2\text{SiO}_2 \cdot 3\text{H}_2\text{O}$ [8, Ullmann's, 2001], [11, Shreve, 1945].

Advanced ceramic products, which contain only a small fraction of clay or none at all, are based on the following materials: oxides, carbides, nitrides and borides of Al, Mg, Mn, Ni, Si, Ti, W, Zr and other metal ions. Typical examples are Al_2O_3 (alumina), MgO (periclase or dead burned magnesia), SiC (silicon carbide), TiN (titanium nitride) and WB_2 (tungsten boride) [8, Ullmann's, 2001].

Clays or argilliferous materials (sedimentary clays, schistous clay, loamy clay, marl) are mostly used for the manufacture of bricks, roof tiles and clay pipes. Organic additives (sawdust, paper binding substances, formed polystyrene) or inorganic auxiliary agents such as kieselguhr or perlite can be added in order to obtain a greater pore volume. In the facing brick and roof tile industry, metallic oxides such as MnO_2 , TiO_2 , Fe_2O_3 , chromites, and minerals such as CaCO_3 , CaMgCO_3 can be added to obtain the desired colour and/or to enhance porosity of the finished product. BaCO_3 can be added to reduce efflorescence. Such additives are added just before the shaping process, or in the raw material preparation, either in solid or liquid form.

Refractory products consist of clay, chamotte (calcined and crushed raw plastic clay) and certain natural rocks such as quartzite, dolomite, bauxite and magnesite, but also of the above-mentioned synthetic materials, as for example sintered corundum, silicon carbide or spinels. In order to produce compressible masses, binders and aggregates are added to the milled raw materials.

The expanded clay industry uses clays with a specific expandability. Additives (e.g. flux, expansion aids, and release agents) are used for promoting expansion [26, UBA, 2005].

Products manufactured by the wall and floor tiles, household ceramics and sanitaryware industry predominantly consist of aluminium silicates and the clay minerals serve as plastic raw materials. However, technical ceramics and inorganic bonded abrasives often contain only a small amount of clay or in the case of technical ceramics none at all and are, therefore, based on the metal borides, carbides, oxides and nitrides as mentioned above.

Quartz, feldspar, in some cases chalk, dolomite, wollastonite and steatite are used as fillers and fluxing materials. Various ceramic products are glazed or engobed on the visible or whole surface with glaze frits or engobing slips.

In addition to the above-mentioned raw materials and auxiliary agents, additional auxiliary agents, firing auxiliaries, fuels and sorption agents are necessary for the manufacture of ceramics. Organic slip additives and binding agents are employed as auxiliary agents in the shaping process. The firing auxiliaries consist of re-usable fire-proofed capsules, plates and stanchions. Sorption agents such as calcium carbonate, calcium hydroxide and fine chalk are employed in flue-gas treatment.

2.2 General production process description

The manufacture of ceramic products takes place in different types of kilns, with a wide range of raw materials and in numerous shapes, sizes and colours. The general process of manufacturing ceramic products, however, is rather uniform, besides the fact that, for the manufacture of wall and floor tiles, table- and ornamentalware (household ceramics), sanitaryware and also technical ceramics, often a multiple stage firing process is used.

In general, raw materials are mixed and cast, pressed or extruded into shape. Water is regularly used for a thorough mixing and shaping. This water is evaporated in dryers and the products are either placed by hand in the kiln (especially in the case of periodically operated kilns) or placed onto carriages that are transferred through continuously operated kilns. In most cases, the kilns are heated with natural gas, but liquefied petroleum gas, fuel oil, coal, petroleum coke, biogas/biomass or electricity are also used.

An irreversible ceramic structure for the product is reached during the firing process in the kiln. This demands a very accurate temperature gradient during firing to ensure that the products obtain the right treatment. Afterwards controlled cooling is necessary, so that the products release their heat gradually and preserve their ceramic structure. Then products are packed and stored for delivery.

In the following Sections 2.2.1 – 2.2.13, the most important units of a ceramic manufacturing plant, as well as the basic steps and variations in the production processes, will be explained [1, BMLFUW, 2003], [2, VITO, 2003], [3, CERAME-UNIE, 2003], [4, UBA, 2001], [5, InfoMil, 2003], [6, Timellini, 2004], [7, Dodd, 1994], [8, Ullmann's, 2001], [10, Navarro, 1998], [13, SYKE, 2004], [14, UBA, 2004], [17, Burkart, 2004], [23, TWG Ceramics, 2005], [26, UBA, 2005], [28, Schorcht, 2005], [29, IMA-Europe, 2005], [30, TWG Ceramics, 2005], [32, TWG Ceramics, 2006].

Regarding the standard conditions for measurements of volume flows and concentrations, see the following definitions, which are also stated in the Glossary:

m ³ /h	volume flow: if not otherwise mentioned in this document, the volume flows refer to 18 vol-% oxygen and standard state.
mg/m ³	concentration: if not otherwise mentioned in this document, the concentrations of gaseous substances or mixtures of substances refer to dry flue-gas at 18 vol-% oxygen and standard state, and benzene concentrations refer to 15 vol-% oxygen and standard state.
standard state	refers to a temperature of 273 K and a pressure of 1013 hPa.

2.2.1 Storage and transport of raw materials

The mining of clay, kaolin, clayey materials, feldspar, quartz and most of the other raw materials used, usually takes place in mines or quarries and in some cases the clay is also obtained from riversides near the production plant (for instance in the Netherlands). Transportation to the production plant is mainly undertaken by truck but also by railway, or if the mine or quarry is located very near to the production plant, conveyor belts can also be used.

Depending on their characteristics and the stage of processing, the raw materials are stored in open stockpiles, warehouses which are subdivided into boxes, large volume feeders, tempering silos, ageing silos, souring silos or dry silos. The silos are equipped with level indicators, overload valves and filters or gas displacement units, where displaced dusty air is blown off. Some materials are also delivered in liquid or slurry form and therefore are stored in tanks or other vessels.

The equipment for transportation within the plant is chosen according to the characteristics of the material conveyed, such as granularity, resistance to attrition and flowability, temperature, flowrate and the given space. The materials are moved with mine hoists such as bucket elevators, chain conveyors, screw conveyors, pneumatic conveyors and slides. The casting slip is partly pumped through pipelines.

2.2.2 Preparation of raw materials

First size reduction and preliminary homogenisation of raw materials is usually achieved in the quarrying operation, but in order to meet the stringent technical requirements of modern ceramic products, further preparation is necessary. One or more of the following processes described in Sections 2.2.2.1 – 2.2.2.10 may be employed, although not necessarily in the same order.

2.2.2.1 Pre-drying

Sometimes certain raw materials need to be pre-dried, for instance sand may be dried using fluidised bed technology and also rotary dryers may be used. Many refined ceramic raw materials are purchased from specialist suppliers – usually in a dry state.

2.2.2.2 Pre-blending

Blending of clays can begin in the quarry, e.g. by selective digging or by stacking the material in superimposed horizontal layers, and then scraping this stockpile vertically to supply feed to the factory.

2.2.2.3 Weathering/souring

Large quantities of clay and mineral raw materials need to be stored at works producing clay bricks and roof tiles, and initial storage is often in the open air. In certain cases – especially in soft-mud processes – storage for a number of months improves the workability of the clay. The process is known as ‘souring’ and the weathering action is most effective over the winter period.

2.2.2.4 Primary and secondary crushing, grinding and screening

Coarse primary crushing of relatively dry/brittle clays may be effected by large toothed kibbler rollers, usually located in the quarry, or by large jaw-crushers. Very hard raw materials (often used to manufacture refractory products) are also reduced in size using jaw or cone-crushers, both of which compress the lumps of mineral between a stationary and a moving hard surface.

Hammer mills achieve size reduction by impact forces – pieces of raw material fed into the mill are shattered when struck by the rapidly rotating hammers.

Edge runner mills (e.g. dry or wet pan grinders) are suitable for reducing the particle size of more plastic raw materials. Pans with perforated base plates ensure a defined maximum particle size, and wet pans have the added function of allowing the tempering of clays with added water.

Crushing rollers are widely employed in the heavy clay industry to disintegrate, flatten and homogenise clay particles. Pairs of parallel, smooth hard-steel rollers are driven in opposing directions so that the raw material, fed between the rollers, undergoes nipping, shearing and flattening. Size control is achieved by setting the gap between the rolls.

Clay shredders (and also roller mills) are useful in the case of plastic raw materials, and consist of a rotating slotted drum fitted with cutter knives. The clay lumps are forced through the slots in the form of shavings.

Impact rotor crushers have two rotors carrying bolted-on impactors or ‘shoes’. They rotate towards each other and achieve continuous turning, mixing and disintegration of the feed material.

2.2.2.5 Dry or wet milling (grinding)

The comminution process described above typically achieves particle sizes of 2 mm or more. Further size reduction is necessary for many ceramic applications, such as wall and floor tiles, refractory products and tableware. Dry or wet roller mills are used to obtain particles of around 1 mm diameter. They consist of rotating vertically orientated rolls operating within an outer ring, and pressure is developed between the roller and ring, e.g. by centrifugal force. Raw material from the primary crushing stage is introduced to the mill with or without water, and ground until the required size grading is achieved. Even finer grinding can be obtained using continuous or batch ball mills (in which hard ceramic spheres are tumbled within horizontally mounted drums).

Ball mills are the normal choice for the ceramic floor and wall tile industry, and when used wet they can produce powders graded below two hundred microns.

2.2.2.6 Dry screening/air classification

In order to optimise certain properties of ceramics (e.g. density), it is sometimes necessary to blend defined size-gradings of material. Dry screening usually involves vibrating screens, heated electrically to prevent the build-up of material and clogging.

Air classifiers based on separating cyclones may also be used for dry powder sizing. In either case, oversize material is usually fed back to the grinder.

2.2.2.7 Spray drying

This process is widely employed in the wall and floor tile industry and also carried out for the manufacture of tableware, technical ceramics and refractory products. The aqueous suspension of raw material resulting from wet ball milling (solids content ~ 60 to 70 %) is sprayed under pressure to produce fine droplets which contact a stream of hot air. Drying of the droplets produces highly uniform, more or less spherical hollow granules (with a moisture content of typically 5.5 to 7 %). This form of powder has high flowability, facilitating accurate filling of the press dies and the subsequent pressing of quite large single tiles. Today, certain companies are specialised in the preparation of spray dried powder. They deliver the prefabricated material directly to the plants of the ceramic industry where further processing then takes place.

2.2.2.8 Calcining

Some ceramic raw materials are pre-fired, usually in rotary kilns, tunnel kilns or shaft kilns, to improve their properties. For example, certain oxides (e. g. dolomite, magnesite) need to be 'dead-burned' at high temperatures, sometimes in excess of 1800 °C, in order to make them suitable for refractory manufacture. Calcining of clays (e.g. kaolin) reduces the plastic shrinkage of bodies to which they are added, aiding size control of products and speeding firing cycles. Today, certain companies are specialised in the preparation of calcined raw materials. They deliver the prefabricated material directly to the plants of the ceramic industry where further processing then takes place.

This document does not deal with these upstream raw material calcining processes, but useful information regarding 'dead burned oxides' and 'calcined chamotte, pigments and fillers' can be found in the Cement and Lime BREF – where the calcination of dolomite is described; in the BREF for Management of Tailings and Waste-Rock in Mining Activities – where the processing of kaolin is described; in the draft BREF on Large Volume Inorganic Chemicals (Solids and Others) – where the production of magnesium oxide is described and in the draft BREF on Speciality Inorganic Chemicals, where the production of speciality inorganic pigments is described.

2.2.2.9 Synthetic base materials

It should be noted that some synthetic materials such as silicon carbide may be manufactured by specialist suppliers, but may still need to go through the comminution process.

2.2.2.10 Frits and glazes, glaze preparation

In ceramic wall and floor tile glazing, raw materials of a glassy nature (frits) are used. Frits are vitreous compounds, insoluble in water, prepared from crystalline materials, made by melting at high temperatures (1500 °C) followed by fast cooling. Frits are supplied to the ceramic tile industry by frit manufacturers (for more information see also the BREF on Glass Manufacturing).

Apart from frits, the major glaze components are silica (glass former), as well as additives that act as fluxes (alkalis, alkaline earths, boron, lead, etc.), opacifiers (zirconium, titanium, etc.), and as colouring agents (iron, chromium, cobalt, manganese, etc.).

In the glaze preparation process, the frit and additives are usually ground in discontinuous drum ball mills until a preset reject is obtained. The glaze passes through vibrating sieves. The conditions of the aqueous suspension are then adjusted. Suspension characteristics will depend on the application method to be used.

A wide variety of glazes are formulated depending on the type of product, firing temperature, and the desired effects and properties of the finished product.

2.2.3 Component mixing

2.2.3.1 General

Mixing time, intensity and sequence have a significant impact on the properties of the mix and consequently on the ultimate product. The prepared raw materials, in controlled proportions, must be mixed and homogenised to achieve the required physico – chemical uniformity. Depending on the ceramic sector concerned, mixing may range from large scale continuous operations to carefully controlled small scale batch mixing. Proportioning may be on a volume basis (e.g. via box feeders placed on conveyor belts), or by mass (e.g. via screw feeders linked to weigh-belts).

Most ceramic forming operations require raw materials with a defined water or bonder content, and minor additives such as pigments, anti-scum agents and binders must be accurately dosed and then uniformly distributed in the mix. In refractory manufacture, the properties of some products are optimised by the careful blending of several grain size fractions of raw material. Proportioning of the mix components is now often automated, with computer control of the feeder mechanisms allowing rapid alteration of the ‘composition’ for the blend. In some cases, mainly in the manufacture of bricks, the clay is also mixed with solid fuel additives (such as fine coke) to reduce firing times.

2.2.3.2 Continuous mixers

Double shaft mixers: these are very widely used in the heavy clay industry and consist of a trough bearing two parallel shafts, which rotate towards each other. The shafts are fitted with paddles and knives, providing a vigorous mixing action. The pitch of the paddles moves the mass forward to the discharge end.

Single shaft mixers: these give gentler mixing than the double shaft version, but are useful for tempering clay mixes with water prior to extrusion. The mixer usually terminates in a screw auger (pug sealer) which compresses the prepared clay mix.

Pan mills (muller mixers): the grinding function of these pans was described in Section 2.2.2.4. In the dry pan version, the pan rotates and the mullers (heavy steel idler-wheels), have a stationary axis, whereas in the case of the wet pan, the pan is stationary and the mullers are driven in a rotary path around the vertical axis. Considerable mixing of clay mix, water and some additives is possible.

Clay shredders and impact rotor crushers: these were also mentioned in Section 2.2.2.4, and again they serve a dual function, giving very good mixing as well as comminution.

2.2.3.3 Batch mixers

The Z-blade mixer (dough mixer): there are several designs, but all work on the same principle of cutting and kneading. They usually deal with plastic raw materials, but can handle drier powders.

Drum mixers: these are suitable for mixing relatively dry materials of uniform size. The charged drum is rotated for the requisite time period.

Rotating pan mixers: these operate on the same principle as large concrete mixers, and are best charged with measured amounts of the individual components whilst the pan is moving. Scrapers, ploughs and baffles are used to achieve intimate blending, and these mixers can mix granular clay with fine powders.

Rotating shaft mixers (blungers): in this version, the pan is stationary and a central shaft rotates, usually carrying arms which themselves bear rotating paddles or blades. The latter sweep the base of the pan with a planetary motion, and achieve similar batch mixing efficiency as the rotating pan type.

Stirred tanks: these are employed for mixing a range of aqueous slurries, slips and suspensions used in the ceramic industry. Although suspending agents are normally included, it is frequently necessary to maintain the stirring action until the slips, etc. are used, either in the mixing tank or in a separate storage tank.

2.2.4 Shaping/forming of ware

2.2.4.1 General

Traditional ceramic products were always shaped from raw materials in the plastic state, and for several millennia, this was a manual operation. At the present time, the demand is for ever more stringent technical specifications covering such properties as dimensional tolerance, density, strength, durability and refractoriness. In many cases, aesthetic qualities are also of prime importance. The method of forming the ware can have a profound effect on their ultimate properties, and a wide range of shaping techniques has evolved in the various sectors of the ceramic industry.

2.2.4.2 Pressing

2.2.4.2.1 Mechanical pressing

This method is still employed for the manufacture of bricks (e.g. semi-dry pressing) and of refractory products. Die boxes are charged with a pre-set volume of clay granules, and pressure is usually applied from above and below, with pistons being driven by cam action and aided by heavy flywheels.

2.2.4.2.2 Hydraulic pressing

Modern hydraulic presses can provide high compaction force, high productivity, consistency and easy adjustment. Many presses are now fitted with electronic control units, which can check the height of units and automatically adjust the cycle to ensure size uniformity. Such presses can be readily adjusted to meet a variety of requirements, including complicated press programmes such as those used in forming complex refractory shapes. Hydraulic pressing is widely adopted for the shaping of tiles. In the case of ceramic tiles, the moist powder (at 5 – 7 % moisture content) is pressed in shallow dies, whereas clay roof tiles are usually formed by pressing plastic clay ‘bats’ cut from an extruded column.

2.2.4.2.3 Impact pressing

This involves a high energy rate forming via pneumatic-mechanical impact between a high velocity ram striking powder in a die. The technique is employed in the manufacture of special refractory products.

2.2.4.2.4 Friction pressing

Mechanically driven friction (screw) presses are, in general, used for producing refractory shapes, although they are gradually being replaced by hydraulic presses.

2.2.4.2.5 Isostatic pressing

Some high quality products require uniform densification, which can be achieved by applying pressure equally on all surfaces. In the isostatic press, rubber or polyurethane moulds are filled with ceramic powder and placed in a liquid filled vessel. A high hydrostatic pressure is then applied, followed by a demoulding of the objects. This technique is used in the refractory and technical ceramics sectors as well as for the manufacture of tiles and tableware.

2.2.4.3 Extrusion

Extrusion is widely employed for the manufacture of clay bricks and blocks, vitrified clay pipes and ceramic floor and wall tiles. The process is also used to make semi finished ‘bats’ for subsequent pressing into roof tiles, refractory shapes, etc. The extrusion process demands a plastic raw material, which usually implies substantial clay content. The plastic body is tempered to the required consistency with water, and then forced through the die of the extruder – usually by a powerful auger. A vacuum de-airing stage is usually included prior to the auger, leading to improved consolidation of the clay column. The latter is finally cut into units of the required length by forcing sections of the column through a number of tightly stretched vertical wires.

Extrusion is well suited to the large scale continuous production of bricks, pipes, etc. and is ideal for making perforated ware including large lightweight building blocks.

2.2.4.4 Moulding

This is a very ancient method of shaping clay objects – the earliest known brick (unfired) dates back more than 10000 years. In many parts of the world, adobe systems are still in regular use. Hand moulding was employed, and simple wooden moulds were developed to ensure a more uniform size and shape. Moulding of clayware demands far less power and energy than pressing or extrusion, but requires a much softer (wetter) mix, leading to higher drying shrinkage and more heat energy input for drying.

Moulded bricks made by the so-called ‘soft-mud’ process have special textural and aesthetic qualities, which are in great demand – partly to maintain the rich architectural heritage of many cities and regions of Europe. Hand-thrown bricks are still made and command high prices, but many moulded bricks are now produced mechanically on sophisticated machines in Western Europe. The machines still ‘throw’ individual clots of clay into pre-sanded moulds. Moulding of ware is also performed in the refractory sector, in order to form large products (sometimes weighing more than one tonne). The mix, which must have a precise viscosity, is cast into the mould. In this case, vibration (applied to the mould or directly to the mix using vibrating pokers) is used to consolidate the mix and ensure complete filling of the mould. This process is known as ‘vibro-casting forming’.

2.2.4.5 Slip casting

This process is extensively used in the manufacture of sanitaryware and table- and ornamentalware, and for manufacturing special and complicated refractory products and technical ceramics. The finely ground mineral material is mixed with water to produce a clay slip (a stable aqueous slurry) which is poured into a porous mould, traditionally made of set gypsum plaster. The capillary suction of the mould draws the liquid from the slurry to form a high solid cast on the inner surface of the mould. Wall thickness increases progressively, and with time a completely solid body can be achieved (if required) before removal from the mould.

Sanitaryware products are relatively large, and are formed by conventional slip casting or (more directly) in pressure casting machines.

2.2.4.6 Fusion casting

This technique is expensive in terms of both cost and energy, so its use is confined to specialist ceramic applications. Refractory bricks are subject to severe chemical and physical attacks from molten slag, clinker, etc. Fusion casting involves pre-melting the selected raw materials and pouring into moulds. The resulting units have high density, low porosity and very strong intercrystalline coherence with a regular microstructure. These properties confer improved resistance to corrosion and erosion, and excellent mechanical strength at high temperatures. A feature of the process is the high shrinkage of the oxides melt on solidification, (of the order of 15 % by volume). Controlled slow cooling is necessary to avoid fracture of the cast pieces and to control the crystallisation process.

2.2.5 Drying of ceramic products

2.2.5.1 General

Traditionally, most clay articles were dried ‘naturally’ by standing in the air at an ambient temperature. In many parts of Europe, this was only effective during summertime. Simple drying ‘hacks’ were employed in the brick and roof tile industry, enabling the setting of superimposed rows of ware under a simple light wooden cover which excluded rain.

In the modern ceramic industry, it is necessary to optimise drying in terms of speed, thermal efficiency and low wastage. With the exception of slow, gentle drying processes, it is necessary to maintain close control of heating rates, air circulation, temperature and humidity. Heat for drying air is now mainly supplied by gas burners and by hot air recovered from the cooling zone of kilns. The heat for drying air can also be supplied with a cogeneration or another fuel such as coal, biomass, biogas or petroleum coke.

Ceramic raw materials vary in their sensitivity to drying, but most benefit from an initial warming-up period in conditions of high humidity (and little or no moisture removal) followed by the main drying stage where the units meet hotter and drier air. The last few per cent of water is harder to remove, requiring the hottest and driest air. Various forms of dryers have evolved to meet the needs of the different sectors of the industry, in which the nature and size of the ceramic components vary enormously.

2.2.5.2 Hot floor dryers

This simple method of drying is no longer widely used, and does not lend itself to mechanisation or automation. However, it is still useful for the slow gentle drying of large and complex ceramic items such as sanitaryware or some refractory products. Some special shaped bricks are also dried in this manner. As the name implies the drying action arises from heat conducted directly to the base of the units in contact with a heated floor, and by convection currents in the air above that floor. Lateral airflow is minimal, and all surfaces of the ware dry at a low rate, avoiding undue stresses on the body during drying.

2.2.5.3 Chamber dryers (intermittent)

These consist of a battery of chambers with close-fitting entry doors, usually served by rail tracks carrying drying cars. The latter are loaded with drying pallets or racks, stacked vertically with uniform spacing. Fully automatic conveying systems have now been developed with transfer-car feeding of permanent racks in the dryer.

Ceramic units such as bricks, blocks, pipes and refractory shapes are set on the racks, and the loaded drying cars are transported into the chambers which are sealed when full. In modern works, the whole operation is highly automated. The chamber temperature is raised at a controlled rate either directly – by the injection of warm air – or indirectly, via heat transfer surfaces. Recirculation of air is used to improve drying efficiency. Heat transfer is mainly through convection, plus a little radiation from the hot air and from heated surfaces. Specific temperature-humidity profiles are followed to suit the particular ceramic product.

Chamber dryers are particularly useful in situations where various ceramic bodies are manufactured; where the bodies have a high water content; or when production is intermittent. It is also relatively easy to build on extra chambers if necessary.

2.2.5.4 Tunnel dryers (continuous)

These are essentially a long tunnel structure through which a line of dryer cars loaded with the green ceramic ware is pushed. High temperature air is fed into the tunnel at the discharge end, and this is induced to flow towards the entry end by one or more fans. As the airflows down the dryer, it transfers heat to the product and its humidity content increases. Recirculation fans are normally installed, thereby increasing turbulence and the drying efficiency. The length of the tunnel dryer depends on the rate of product throughput required, and the water content of the ceramic material.

2.2.5.5 Vertical 'basket' dryers

The vertical dryer is used mainly in the ceramic tile sector and the tiles are fed into baskets consisting of several decks of rollers. The groups of baskets move upwards through the dryers, where they meet hot drying gases. The temperature in this type of dryer is normally less than 200 °C, and the drying cycles range from 35 – 50 minutes.

2.2.5.6 Horizontal multi-deck roller dryers

These dryers are also widely used by ceramic tile makers. The horizontal dryers are designed on the principle of the roller hearth kiln. The individual tiles are fed onto different decks within the dryer, and are conveyed horizontally by driven rollers. Burners located on the sides of the dryer produce the hot drying air, which flows countercurrently to the ware.

The maximum temperature in these dryers is usually higher than in the vertical option (around 350 °C) and the drying cycles are shorter, between 15 and 25 minutes.

2.2.5.7 Dehumidifying dryers

These dryers are normally intermittent (chamber) units. The technique relies on maintaining the humidity level of the air in the drying chamber well below saturation, so that water continues to evaporate from the ware, without requiring an increase in temperature. To maintain this effect, water vapour must be continuously removed from the chamber, which is usually achieved by circulating the air through a refrigerated condenser.

Such dryers must be extremely well sealed to prevent ingress of potentially moist ambient air, and are normally equipped with programmable humidity controls to optimise drying. The scale of such dryers is limited but they are well suited to drying sensitive ceramic products, special shapes, etc. This drying technique only produces liquid water as a waste stream.

Another possibility is to introduce saturated steam into a tunnel dryer. In this tunnel vapour dryer, the moisture of the drying air is reduced in the different sectors of the dryer to guarantee controlled drying.

2.2.5.8 Infrared and microwave dryers

Infrared and microwave dryers can in principle also serve as alternatives to conventional dryers. In this context, especially regarding microwaves see Chapter 6 'Emerging techniques for ceramic manufacturing'.

2.2.6 Surface treatment and decoration of ceramic products

2.2.6.1 Texturing of clay products

The surface of clay products may be textured for functional reasons, e.g. to provide a non-slip finish to floor tiles.

A wide range of textures is also applied to clay products for aesthetic reasons. Soft mud bricks acquire a pleasing random 'fold' pattern as the clay clot is thrown into the mould, and hand throwing produces especially desirable finishes. Extruded products can be drag-textured by scraping the surface of the clay column. An alternative technique is to extrude slightly oversize, then to trim to the correct height and width using cutting wires.

A better drag-texture can sometimes be obtained by omitting de-airing of the clay column. Textured rollers can impart a variety of textures to extruded products.

Pressed bricks are often quite hard in the green state and after assembling as a continuous column on a conveyor belt, rotary cutters are used to 'rusticate' or otherwise texture these bricks. They may also be roll-textured, often after a preliminary mist-spray with water to soften the surfaces.

2.2.6.2 Applied facings

Soft mud bricks receive a surface coating of sand from the inside of the moulds, which are pre-coated with the sand to act as a release agent. A variety of textures and fired colours can be achieved by selecting the sand to suit the aesthetic requirements.

In the case of pressed or extruded bricks, blocks or roof tiles, sand or other granular minerals can be applied to header and stretcher surfaces via compressed air blasting guns. In many cases, pigments are added to the sand in order to vary the aesthetic finish.

2.2.6.3 Glazing, engobing and other decorating techniques

There is a small specialist market for glazed bricks. Glazing is most common in the manufacture of ceramic wall and floor tiles, sanitaryware and tableware and currently there is a growing market share for roof tiles as well. Engobing is mainly employed in the manufacture of clay roof tiles and ceramic wall and floor tiles.

Finely ground glaze components – mainly frits in the case of ceramic tiles – are prepared as aqueous suspensions. The viscosity and suspension characteristics are adjusted to suit the method of application, which may be spraying, waterfall glazing, dry glazing or decorating. During the glazing process, the dried green ceramic ware is in most of the sectors mentioned above – except sanitaryware – hardened by biscuit firing and then, depending on the applied glaze components, covered with a glassily melting, smooth, closed transparent or dusky layer.

An engobe is usually applied after the drying process, in some cases the products are engobed even as green or fired ware. During the engobing process, a fine grained, non-transparent light or coloured layer of a ceramic mass is spread to the visible or whole surface by dipping or pouring.

Screen printing is one of the decorating techniques for tiles, due to the ease of application in the glazing lines. The technique consists of printing a given design by means of one or more printing screens (tensioned fabric with a set mesh aperture). The screen surface is masked, and the printing ink only penetrates the openings of the designs to be reproduced. A squeegee forces the ink through these openings, thus printing the design on the tile.

Other decorating techniques are the gravure technique and flexo space printing. In these techniques, the pattern is transferred directly on one or more rolls. The ink is applied to the tile from these rolls and this technique enables printing on the edges of the tiles or relief tiles. Also, the inkjet printing technique is emerging nowadays. In the case of tableware, often hand painting or sliding ornaments are also applied.

2.2.7 Firing

2.2.7.1 Aims of firing

Firing is a key process in the manufacture of ceramic products, as it controls many important properties of the finished ware. These include mechanical strength, abrasion resistance, dimensional stability, resistance to water and chemicals, and fire resistance.

2.2.7.2 Physico-chemical changes during firing

Raw materials used in ceramic bodies are usually complex mixtures of clay minerals, with other mineral matter such as quartz, feldspars, carbonates, gypsum, iron oxides and sometimes organic matter. Refractory products are also made from a wide range of non-clay minerals, together with specialised additives and binders (which may include some clays). When clay-based ceramic products are fired in a kiln, any residual moisture is driven off at temperatures of between 100 and 200 °C. If organic matter and iron pyrites are present, oxidation takes place at temperatures of between about 300 and 500 °C. Water combined within the structure of clay minerals ('crystal water') is usually released at temperatures of between 500 and 650 °C, whilst carbonates such as calcite and dolomite dissociate with the release of carbon dioxide in the temperature range 750 to 950 °C.

The most important changes relating to the development of ceramic properties involve the breakdown of the lattice structure of the original clay minerals, followed by the formation of new crystalline compounds and glassy phases. The temperature at which vitrification (glass formation) takes place, varies according to the mineralogy of the clay. Vitrification usually commences at about 900 °C and is completed by about 1050 °C (for many brick clays) or about 1100 °C in the case of more refractory fireclays.

During the vitrification stage of ceramic firing, many non-clay minerals such as quartz, oxides or iron, lime compounds and alkalis (oxides of sodium and potassium) become incorporated in the fired body. Some sintering and solid solution occurs, and eutectic reactions take place at the interface of mineral grains and melt phases.

Non-clay products such as some refractory products also depend on sintering, vitrification or recrystallisation stages, but in most cases much higher temperatures are required to achieve the desired properties. In the following figure the ranges of industrial maturing temperatures for different product groups are presented [4, UBA, 2001], [23, TWG Ceramics, 2005], [30, TWG Ceramics, 2005].

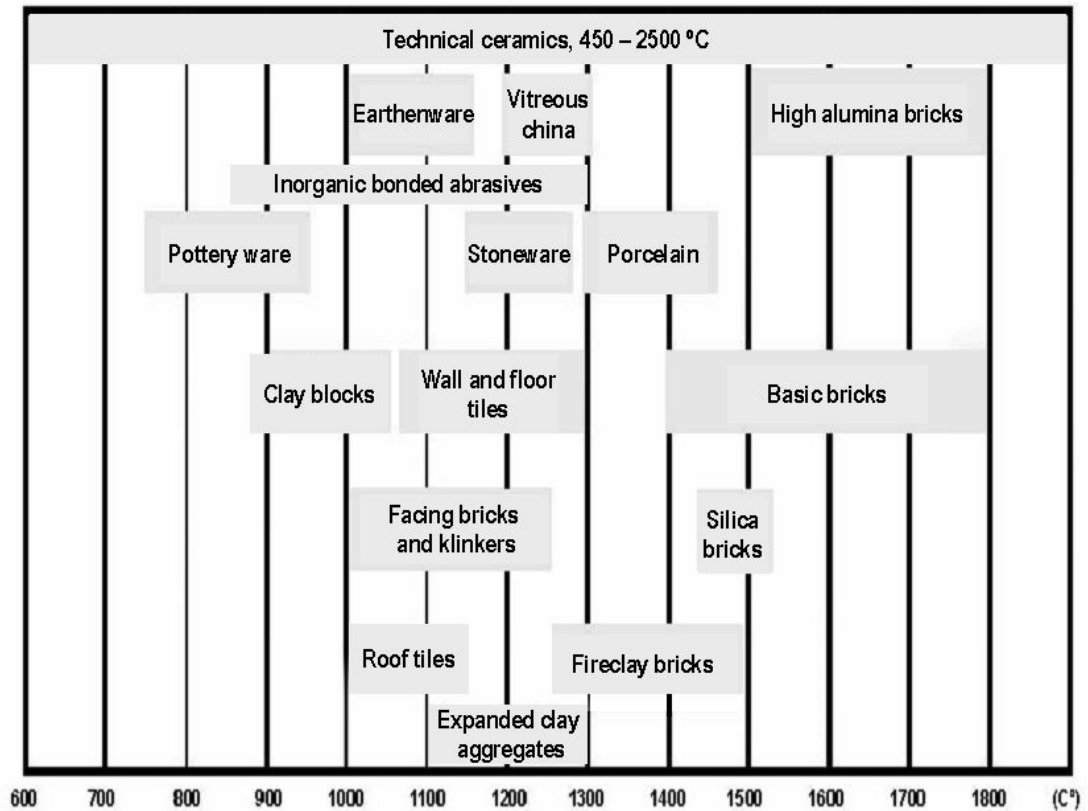

Figure 2.1: Ranges of industrial maturing temperatures for different product groups

The temperatures necessary for the firing process are mainly created by burning natural gas and fuel oil. In some cases, solid fuels, biogas/biomass and electric power are also used for heat generation.

2.2.7.3 Intermittent (periodic) kilns

These include shuttle and hood-type kilns, based on single chambers, which are charged with pre-dried ceramic products (in a hood-type kiln, the hood equipped with the heating unit is placed on the bottom by a hoisting unit; in shuttle kilns, the ware to be fired is brought to the hearth area in a shuttle car), sealed, and then subjected to a defined firing cycle. Gas burners are usually employed and good control of temperature and kiln atmosphere (oxidising or reducing) can be achieved.

Electricity can also be used to heat intermittent kilns, for instance in the manufacture of technical ceramics. Special kiln types for technical ceramics are, e.g. HIP (hot isostatic pressing), high temperature kilns, and kilns with a protective atmosphere.

Intermittent kilns are mainly used for smaller scale manufacture of specialised products, such as special shaped bricks and pipe fittings, roof tile fittings, refractory products, etc. They offer flexibility when the ceramic body composition is altered frequently, and these advantages outweigh their somewhat lower energy efficiency. The following figures show the cross-section of a shuttle kiln [4, UBA, 2001], [30, TWG Ceramics, 2005].

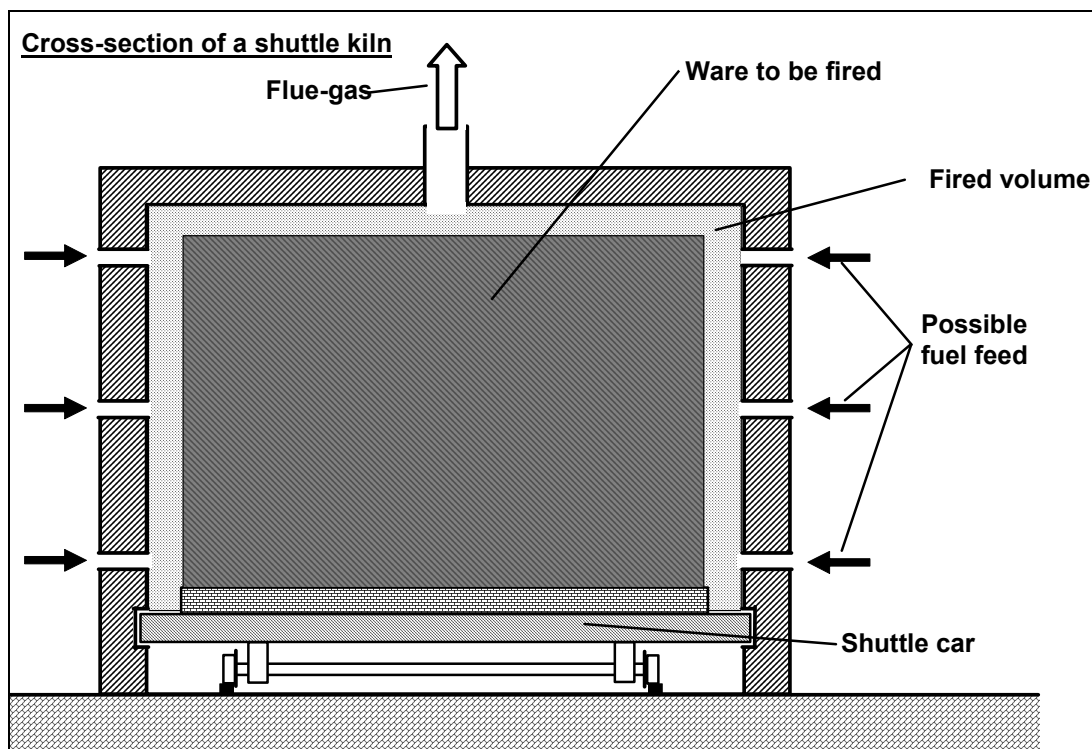

Figure 2.2: Cross-section of a shuttle kiln

2.2.7.4 Continuous kilns

2.2.7.4.1 Chamber (Hoffmann) kilns

These consist of a series of linked chambers, which are sequentially filled with dry ware (e.g. bricks), sealed, fired quasi-continuously and the hot gases are drawn from one chamber to the next. This connecting system with flues and holes between the chambers also allows the preheating of the ware, the cooling of the flue-gases and so results in improved thermal efficiency and lower costs compared to intermittent kilns. The kilns are now mainly gas-fired, but top feeding with oil or coal is occasionally practised. They are mainly used for the manufacture of specialised products, for example special coloured bricks.

2.2.7.4.2 Tunnel kilns

These are essentially refractory tunnels served by rail tracks carrying kiln-cars. The latter have refractory decks on which dried ware is set in defined stable patterns. The cars are pushed through the kilns at set intervals, countercurrently to a flow of air drawn by fan(s) to an exhaust duct near the car entry zone. Most tunnel kilns are now gas-fired, with a maximum temperature in the firing zone near the centre of the kiln. Incoming ware is preheated by hot gases from the firing zone, whilst incoming air cools the fired ware and is itself preheated for its combustion role. A proportion of this air from the cooling zone is usually drawn off to the adjacent dryers, giving significant fuel economies.

The firing chamber and kiln-cars are usually sealed against secondary air with a sand seal. The latest kiln constructions are sealed by water or other improved mechanical solutions. The aim of these procedures is to reduce firing times and energy consumption by having a gas-tight firing chamber.

Figure 2.3 and Figure 2.4 show a schematic view of the layout and cross-section of a tunnel kiln [4, UBA, 2001], [23, TWG Ceramics, 2005].

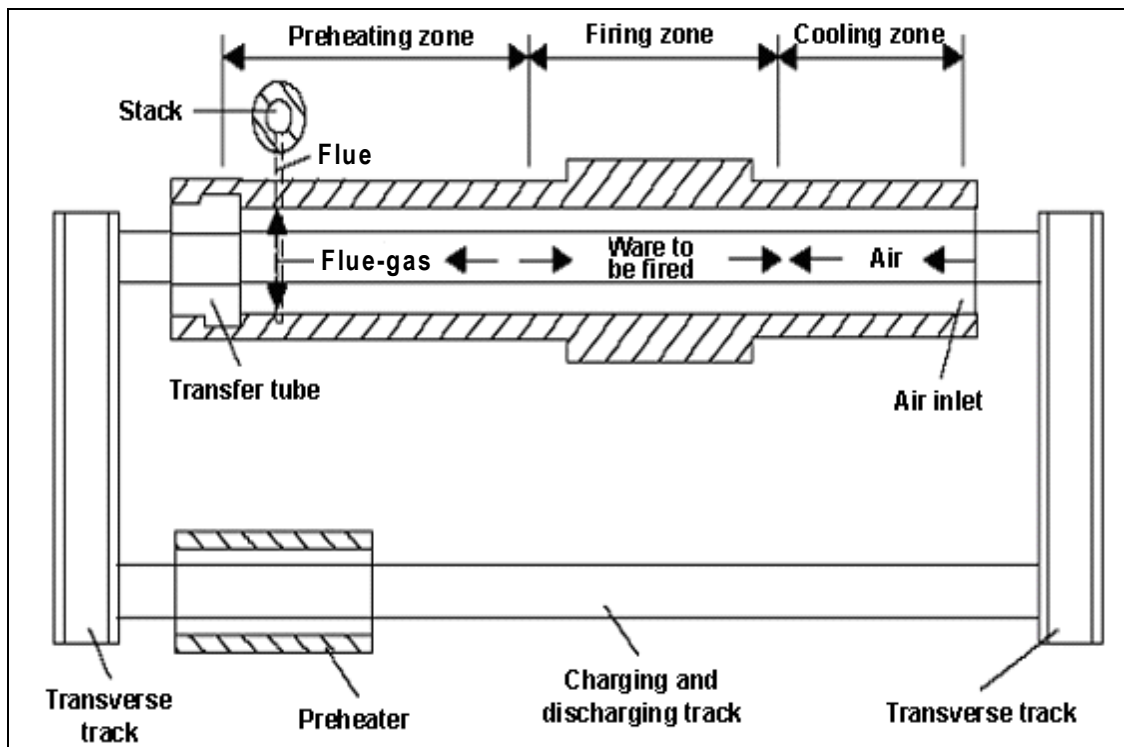

Figure 2.3: Schematic view of a tunnel kiln

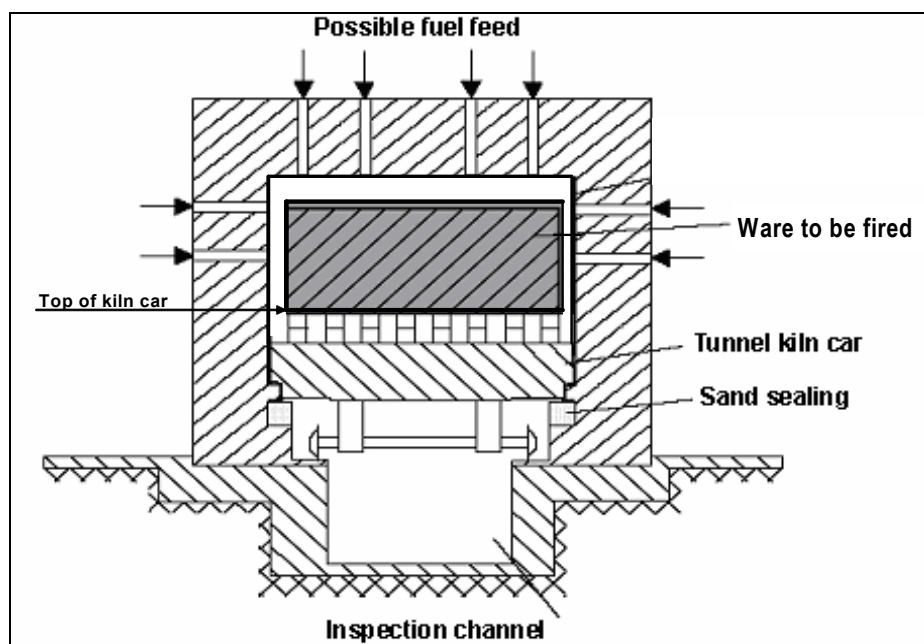

Figure 2.4: Cross-section of a tunnel kiln with a tunnel kiln car

2.2.7.4.3 Roller hearth kilns

Single-deck roller kilns are now almost universally used for wall and floor tile production, and firing schedules have been reduced to less than 40 minutes. Tiles travel over driven rollers, and the heat required for firing is provided by natural gas-air burners located at the sides of the kiln. The main heat transmission mechanisms are convection and radiation, and as the kilns are non-muffled, the heat transmission coefficients are raised, reducing the firing cycle and energy consumption. Roller hearth kilns are also sometimes used for the production of clay roof tiles, vitrified clay pipes, sanitaryware and tableware. The following figure shows the cross-section of a roller hearth kiln [4, UBA, 2001], [30, TWG Ceramics, 2005].

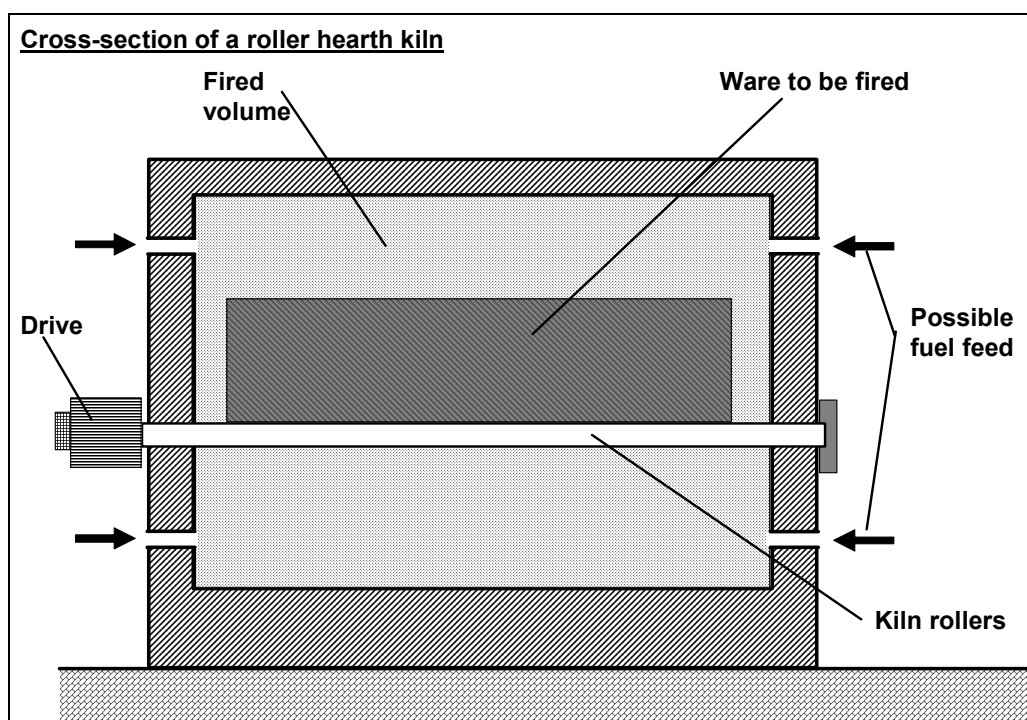

Figure 2.5: Cross-section of a roller hearth kiln

2.2.7.4.4 Sliding bat kilns

These are also fast firing, and operate on a similar principle to the roller hearth kiln. However, the ware in this case is placed on refractory 'carriages' which move on wheels borne by tracks outside the kiln proper. The sliding bat kiln can accept ware of a more irregular shape and size, whereas a roller hearth kiln can only deal with regularly shaped items.

2.2.7.5 Clamp firing

A limited production of traditional stock bricks is still carried out by clamp firing. Dried bricks containing a solid fuel additive (such as fine coke) are built into large, dense rectangular settings – called clamps – on a foundation of fired bricks. Flues are left in the base layers, with layers of coke to initiate firing. The clamp is finally clad with fired bricks, sloping the outer walls inwards for stability.

Once ignited, the fire progresses slowly by combustion of the fuel within the bricks. Firing of the clamp takes several weeks, including time for cooling, after which the clamp is stripped down manually and the bricks sorted into defined grades.

2.2.7.6 Rotary kilns

A rotary kiln has the form of a long cylinder, usually inclined and is slowly rotated about the axis. The kiln is fired by a burner set axially at the lower end. Rotary kilns are used for the manufacture of expanded clay aggregates.

Rotary kilns can also be used for the calcination of fireclay and for dead burning of dolomite or magnesite. This document does not deal with these upstream raw material calcining processes, but useful information regarding ‘dead burned oxides’ and ‘calcined chamotte, pigments and fillers’ can be found in the Cement and Lime BREF – where the calcination of dolomite is described; in the BREF for Management of Tailings and Waste-Rock in Mining Activities – where the processing of kaolin is described; in the draft BREF on Large Volume Inorganic Chemicals (Solids and Others) – where the production of magnesium oxide is described and in the draft BREF on Speciality Inorganic Chemicals, where the production of speciality inorganic pigments is described.

2.2.7.7 Fluidised beds

A fluidised bed is a bed of solid particles maintained in suspension in a gas and thus behaving rather like a fluid. The powder to be fluidised is supported on a porous base, e.g. a trough of special ceramic material, through which the gas (usually air) is fed from below and under pressure. The principle is used as a method of conveying powders along a slightly inclined porous ceramic trough. The powder can be simultaneously dried and/or calcined.

2.2.7.8 Cooling stage heat recovery

Where possible, the cooling of fired ceramic ware is accelerated by forced air circulation through the products soon after the firing zone. This results in considerable volumes of clean, hot air, much of which is drawn from the kiln by fan action and utilised in the drying operation. This method of heat recovery is particularly effective when applied to tunnel kilns.

2.2.8 Subsequent treatment (product finishing)

2.2.8.1 Machining (grinding, drilling, sawing)

Machining operations may be necessary to produce ceramic products whose final shape or dimensional tolerance cannot be achieved technically or with sufficient accuracy during primary processing (especially for larger shapes or blocks).

2.2.8.1.1 Wet grinding

Wet grinding is utilised to finish products requiring the tightest dimensional tolerance. Grinding is a batch process, in which a number of pieces are fixed to a table, which traverses under a diamond machining head. Bed surfaces of building bricks or blocks are sometimes smoothed by wet grinding to facilitate bonding with thin-layer ‘glues’.

2.2.8.1.2 Dry grinding

Dry grinding of clay block bed surfaces with diamond wheel grinding systems is carried out as subsequent treatment to facilitate bonding with a thin layer of mortar. In the case of dry grinding, the whole grinding device is encapsulated.

2.2.8.1.3 Drilling

Ceramic products, especially refractory products may need to be drilled when the ‘hole’ required cannot be achieved with the necessary accuracy during the pressing and firing operations.

2.2.8.1.4 Sawing

This is a finishing operation used when the final shape of a ceramic brick, especially a refractory brick, cannot be effectively produced at the pressing stage. In this situation, oversize bricks are pressed and fired, then sawn to the required dimensions.

Facing bricks may be sawn in the manufacture of 'cut and stuck' special shapes. In virtually all machining operations, a closed loop water system provides lubrication and sweeps lubricated particles away from the working surfaces – at the same time, minimising dust release.

2.2.8.2 Polishing

In some cases, particularly involving porcelain tiles, the fired surface is polished to achieve a shiny, unglazed homogenous tile.

2.2.8.3 Carbon enrichment (refractory products)

Refractory products are required to work in extremely hostile working environments, and for certain applications it is necessary to impregnate fired ware with petroleum-based pitch. The presence of carbon in the final product offers several advantages:

- it acts as a lubricant, beneficial for the working surfaces of sliding-gate plates
- the relatively high thermal conductivity of carbon increases the thermal shock resistance of the product
- the carbon acts as a pore filter reducing the permeability of the product, which in turn offers increased resistance to penetration by slag and metal.

Pitch impregnation is a batch process, typically carried out in three upright cylindrical vessels fitted with hinged lids. Products for treatment are loaded into metal baskets, which fit inside the vessels. The ware is heated in the first vessel to ~ 200 °C via a circulating stream of hot air, then the basket and contents transferred to the second vessel (referred to as an autoclave), which has a heating jacket to maintain the temperature. The autoclave is then sealed, evacuated and filled with liquid pitch (drawn from bulk storage tanks maintained at temperatures of around 180 to 200 °C). Impregnation is achieved by releasing the vacuum, then applying nitrogen at an elevated pressure. After draining, the basket and contents are transferred to the third vessel for cooling to a temperature below that at which volatile pitch components may be evolved.

Finally, it is necessary to remove a high proportion of pitch volatiles, which would adversely affect the working environment when the refractory products were put into service. Typically, this is achieved by transferring the impregnated ware to an oven, to undergo a defined heating cycle. The oven exhaust fan discharges into a thermal oxidiser (incinerator) held above 800 °C, with a dwell-time of at least 0.5 seconds. These conditions ensure that all pitch volatiles (complex hydrocarbons) are fully oxidised.

Products which have been through the above treatment emerge coated in light, brittle carbonaceous deposits which must be removed prior to packaging or further processing. This is usually achieved by short blasting the products on a blasting table.

2.2.8.4 Tumbling of facing bricks

Certain facing bricks are given an antique finish by passing them through a rubber-lined rotating inclined drum. Sharp corners are removed by attrition, producing a softer profile. In some cases, splashes of calcium carbonate (ground limestone), soot or pigment are added, reproducing the appearance of recovered bricks, which have a recognised architectural role.

2.2.9 Addition of auxiliary materials

2.2.9.1 Jointing materials (pipes)

Since most pipes are installed underground as drains, sewers, etc. reliable jointing is necessary. Stable plastic sleeves and seals have been developed by the industry.

2.2.9.2 Silicones/water repellents

Fired clay units show a wide range of porosity values, and spraying or dipping of the ware in silicone solutions is sometimes employed to give more impermeability and to avoid organic growth and efflorescence. This technique is especially used for roof tiles.

2.2.9.3 Insulation materials

Insulation materials – e.g. polystyrene or mineral wool – are inserted into certain large hollow clay blocks and LWA blocks in order to enhance their thermal insulation properties.

2.2.9.4 Carding and plating (refractory bricks)

To assist the installation of refractory products and the burning-in of the kiln or furnace lining, thick cards or metal plates may be glued to one or more surfaces of fired bricks. A card acts as an expansion joint, burning away as the kiln/furnace is brought up to the operating temperature. Metal plates will melt under similar circumstances, effecting a bond between adjacent bricks.

2.2.9.5 Adhesives

Stable adhesives (usually epoxy-based) are used to assemble ‘cut and stuck’ special shapes of roof tile fittings, clay bricks or blocks.

2.2.9.6 Final assembly

Some products are completed in a final assembly step, for example the mounting of metal flanges on high voltage insulators to fix them in bushings, transformers or other applications.

2.2.10 Sorting, packaging and storage

Sorting and packaging may still be a manual operation, as in the case of some types of clay bricks, roof tiles, and shaped refractory products, as well as table- and ornamentalware. However, tighter control of firing has considerably reduced broken ware in recent years, so the tendency is towards more automated systems. Even colour can now be measured instrumentally, which is important in the case of ceramic tiles. Kiln setting of clay bricks and blocks showing very low waste are mechanically consolidated into packs ready for shrink-wrapping – the customer accepting the possibility of 1 – 2 % imperfect units.

Regularly shaped ceramic units such as bricks, blocks, pipes and refractory units are normally strapped into standard sized packs, which are often subsequently polyethylene-wrapped and may be palletised.

Ceramic products at the top end of the value range, such as table- and ornamentalware, demand rigorous inspection and sorting followed by sophisticated protective packaging. In contrast, unshaped refractory products are usually simply weighed into bags and then palletised. Metal drums are also used for storage.

Ceramic tiles are – individually – somewhat fragile, but when tightly packed in cardboard boxes, prove remarkably robust during handling and transportation.

Storage of heavy clay goods made on a large scale is often outdoors, but products which are bagged or boxed require warehouse storage, as do certain moisture sensitive refractory products.

2.2.11 Supply and disposal (off-gas treatment and process waste water treatment) facilities

Dust extraction and kiln flue-gas treatment units, process waste water treatment plants and fuel storage are important supply and disposal facilities of plants manufacturing ceramic products. Depending on the dust emissions, dedusting units are built as central or local centrifugal force preseparators, fibrous fabric filters, wet separators and electrostatic precipitators. According to the type of emission, further flue-gas treatment units are used in the ceramic industry, for example scrubbers and dry sorption plants as well as thermal and catalytic afterburners. These units are mainly located near the main source of emissions, i.e. the kiln.

Process waste water resulting from the manufacturing of ceramic products mainly contains mineral components. Process waste water cleaning units are often built as sedimentation basins. Sedimentation of the inorganic mineral components can be accelerated by the use of flocculation and coagulation agents.

Fuel storage depends on the characteristics of the fuel used. Coal in lumps is stored in open-air storage systems and storage sheds, and pulverised coal is stored in silos. Liquefied petroleum gas is stored in special pressure reservoirs. Fuel oil is stored in tanks, whereby heavy fuel oil has to be heated to guarantee pumpability. Natural gas is delivered by the supply network of the gas company. Additional useful information regarding storage of fuels can be found in the Storage BREF (ESB).

Depending on the processing, further supply facilities such as mould production facilities are necessary. These facilities produce plaster moulds which are used in large quantities, e.g. in the production of roof tiles.

2.2.12 Recycling in the ceramic industry

Most sectors of the industry recycle materials such as off-cuts, trimmings and substandard articles back to the raw material preparation stage. Fired goods of lower quality may also be recycled within the factories, usually after crushing and screening to form granular ‘grog’. This is non-plastic, and can confer benefits like easier drying and lower shrinkage when added as a controlled proportion of clay bodies due to the increase of permeability. Even if ‘fired process loss’ recycling is not suited to the process from which it originated, it may find an outlet in a different ceramic process.

Used refractory products removed whilst relining a kiln may be contaminated by slags, salts, glass or metal, which could compromise the refractory properties of any body to which they were added. Similarly, also various other contaminated materials (e.g. with heavy metals contaminated materials, derived from glazes) may be unsuitable for recycling. Plaster moulds which reach the end of their functional life represent another process loss which cannot be re-used, but in some cases they can be used as raw material in the cement industry.

However, in other cases – notably facing bricks and clay roof tiles – recovery and re-use is widely practised, and recovered bricks are in a great demand. Throughout Europe, large numbers of Roman bricks are still found in masonry structures. It should be noted that some of the uses of granular or finely ground bricks or roof tiles would be applicable to similar size gradings of fired ware from other sectors. Also crushed and graded ‘ceramic process loss material’ finds use as a partial aggregate in concrete for construction purposes, or as a filler in asphalt for road construction.

2.2.13 General process flow diagram showing different processing paths

The following figure summarises the description of the different processes and illustrates different possible paths in the manufacturing of ceramic products [4, UBA, 2001], [23, TWG Ceramics, 2005].

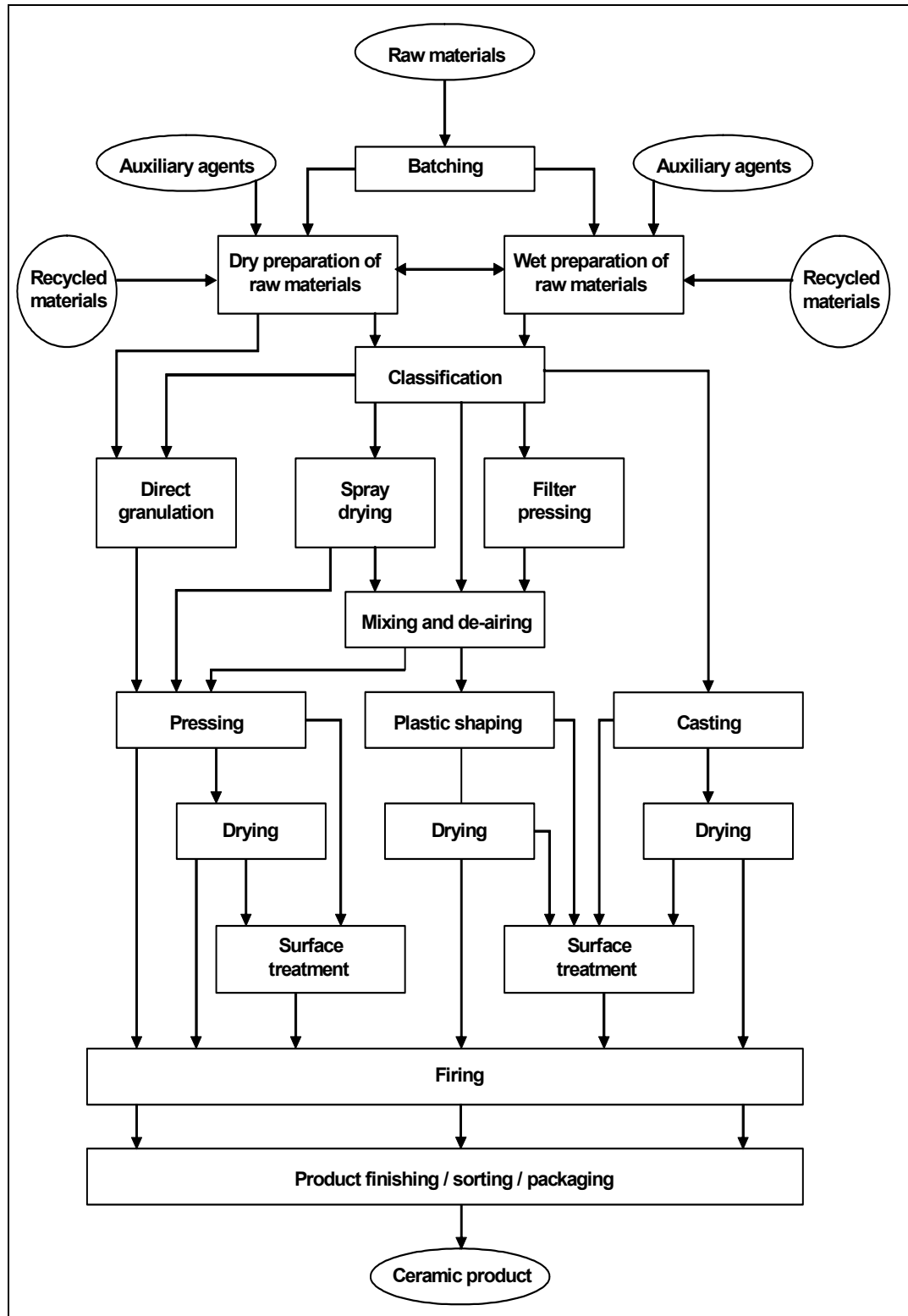

Figure 2.6: General process flow diagram showing different processing paths

2.3 Description of techniques for the manufacture of ceramic products sector by sector

2.3.1 Bricks and roof tiles

In both types of works, brick works and roof tile works, the manufacture of bricks and roof tiles goes through the stages of mining/quarrying of raw materials (this activity is not covered in this document), storage of raw materials, raw materials preparation, shaping, drying, firing and subsequent treatment. Special requirements for the surface and colour of the products involve a surface treatment by glazing, engobing or profiling. The following figure shows, as an example, a schematic view of the manufacture of pressed roof tiles [4, UBA, 2001].

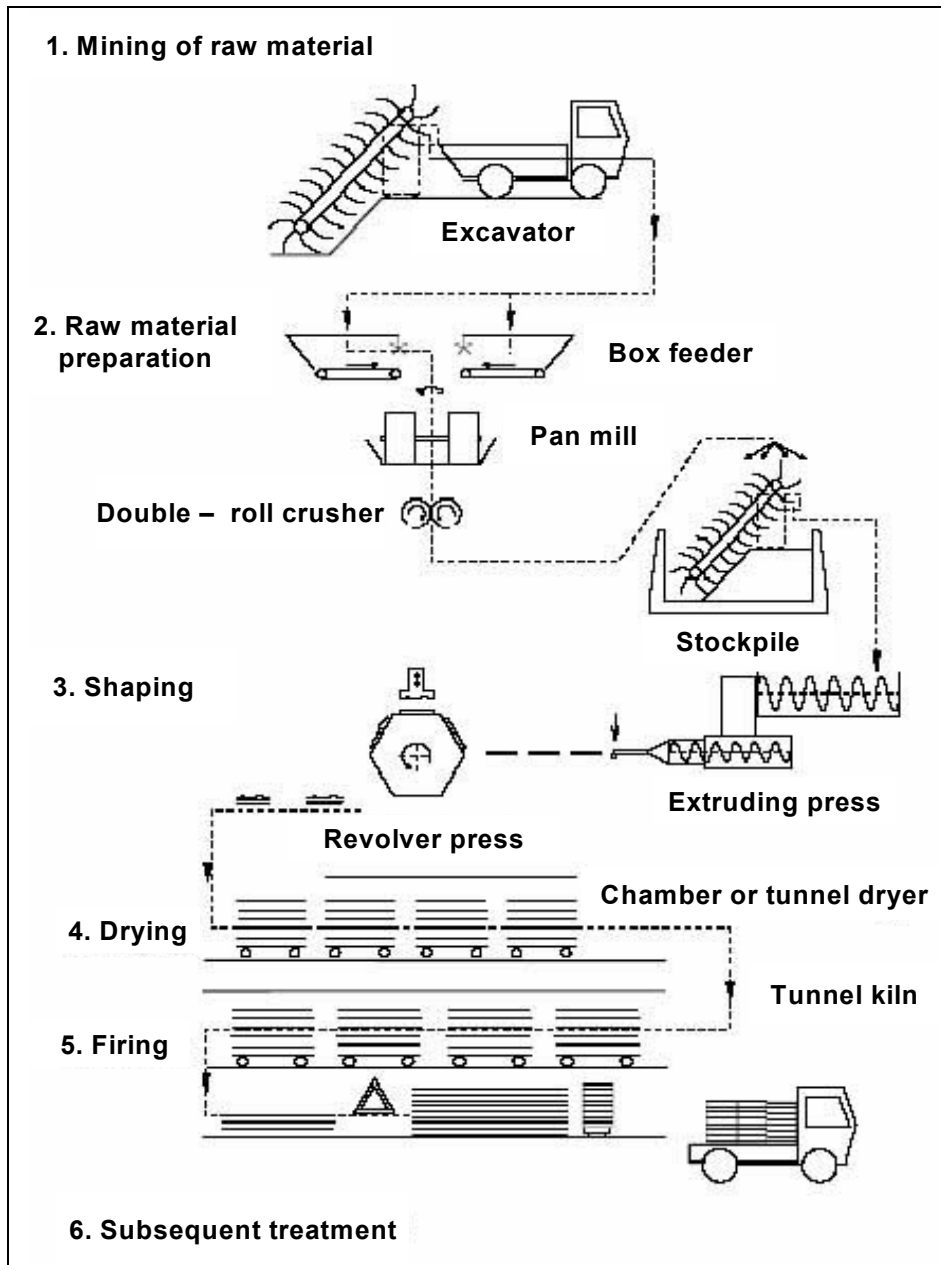

Figure 2.7: Schematic view of pressed roof tile manufacture

The following figure shows, as an example, a schematic view of the manufacture of masonry bricks [20, CERAME-UNIE, 2004].

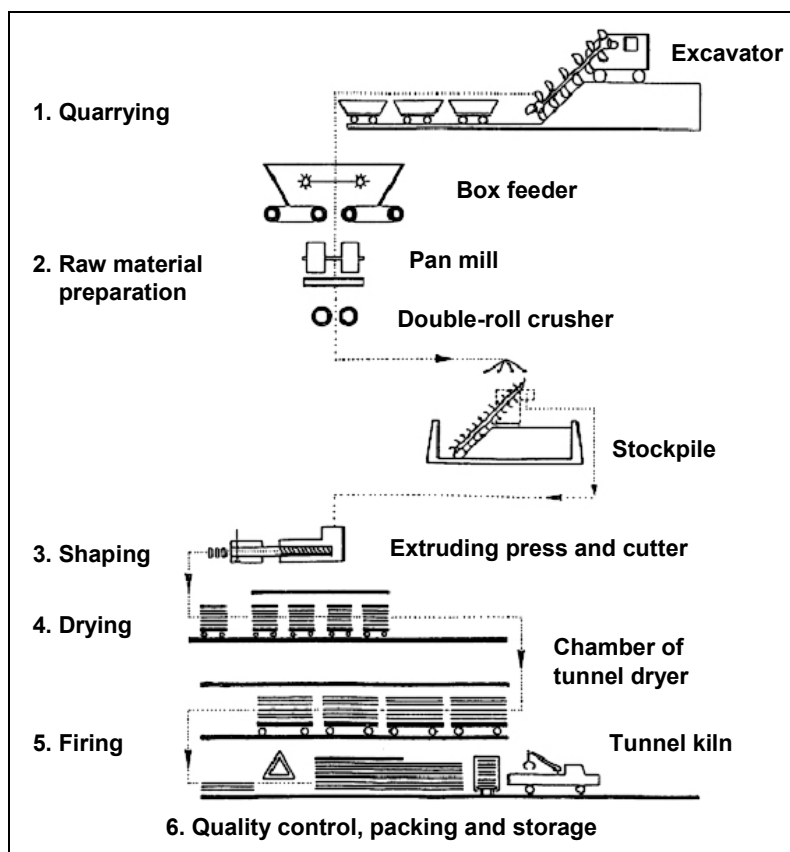

Figure 2.8: Schematic view of preparation of extruded bricks in masonry brick manufacture

2.3.1.1 Raw materials

The geology of brick and roof tile clays used in the European ceramic industry is extremely varied as they cover a wide stratigraphic range from the Cambrian period to recent times. Most brick and roof tile clays are sedimentary in origin and were laid down under a wide range of sedimentary environments: marine, alluvial, fluvial, river-glacier sediments. The range in depositional environments affects the clay mineralogy and the chemical composition. The mineralogical and chemical composition of clays used in the ceramic industry is very different in different European countries. Also within one country a wide range of compositions can be employed. The following table shows the ranges of chemical and mineralogical compositions of clay raw materials, applied in the brick and roof tile industry in different European countries [20, CERAME-UNIE, 2004], [30, TWG Ceramics, 2005].

Country	Austria		France		Netherlands		Hungary		Italy		Greece		Denmark		Belgium		UK		Switzerland		Germany		European range in 11 countries		
	Min	Max	Min	Max	Min	Max	Min	Max	Min	Max	Min	Min	Max	Max	Min	Max	Min	Max	Min	Max	Min	Max	Min	Max	
Chemistry (wt-%)																									
S	0.00	1.30	0.00	0.50	<0.01	1.50	0.01	0.75	0.01	0.62			0.03	0.70	0.01	2.05	0.01	2.00	<0.01	0.50	0.01	2.00	0.00	2.05	
F	0.05	0.10	0.00	0.15	0.02	0.10	0.02	0.10	0.04	0.13			0.03	0.08	0.02	0.07	0.02	0.09	0.00	0.08	0.03	0.16	0.00	0.16	
CO ₂			0.0	14.0	<0.01	10.0							0.0	16.0	0.2	3.6									
SiO ₂	50.3	70.8	35.0	80.0	53.2	80.6	42.2	63.0	33.1	74.4	6.85	75.42	49.5	66.3	62.6	74.0	40.5	74.5	35.0	77.0	50.0	70.0	33.05	80.60	
Al ₂ O ₃ +TiO ₂	9.6	18.8					8.6	17.6																	
Al ₂ O ₃			8.0	30.0	7.3	18.1			8.1	21.0	5.85	20.22	11.7	17.9	5.5	14	9.0	24.5	7.0	29.0	7.0	20.0	5.47	30.0	
Fe ₂ O ₃	4.2	8.2	2.0	10.0	2.0	8.4	2.9	7.6	2.7	7.6	2.19	39.03	4.8	7.2	2.8	4.3	3.9	11.5	2.4	10.0	1.0	8.0	1.00	11.50	
MgO	0.2	3.6	0.0	5.0	0.5	2.7	1.4	4.5	0.7	7.2	0.24	12.90	1.3	2.5	0.9	1.5	0.2	6.6	<1	5.2	0.5	3.0	0.00	7.21	
CaO	0.6	15.0	0.0	18.0	0.0	8.7	2.1	15.2	0.2	26.0	0.91	25.20	0.3	12.9	0.3	5.6	0.2	17.5	3.0	23.0	0.5	15.0	0.00	26.00	
Na ₂ O	0.4	1.7	0.1	1.5	0.2	1.0	0.2	1.2	0.2	14.1	0.37	3.06	0.8	0.8	0.4	1.0	0.2	0.6	0.2	1.5	0.3	1.2	0.10	14.13	
K ₂ O	1.7	3.0	0.1	4.5	1.3	2.3	0.6	1.3	1.4	4.3	0.11	3.19	2.9	2.9	1.5	3.0	1.6	5.9	1.0	2.7	1.0	4.0	0.10	5.90	
TiO ₂			0.3	2.0	0.5	1.3			0.5	1.1	0.20	1.22	0.6	0.8	0.5	0.8	0.6	1.6	0.3	1.5	0.5	2.0	0.30	2.00	
CaCO ₃												1.63	45.00												
MgCO ₃												0.50	31.00												
MnO												0.01	0.15												
Mineralogy (%)	Min	Max	Min	Max	Min	Max	Min	Max	Min	Max	Min	Min	Max	Max	Min	Max	Min	Max	Min	Max	Min	Max	Min	Max	
Quartz	21	49	0	70	39.5	71	16	32	16	54			35	50	34	65	10	55	13	55	15	60	0.00	71.00	
Feldspar	5	15	infrequent		1	12	3	14	1	24			10	20	10	15	0	25	<1	33	1	25	0.00	33.00	
Calcite	<2	26	0	30			0	14	1	41			<1	25	0	8	0	17	<1	37	1	25	0.00	41.00	
Calcite Dolomite +			infrequent		0	20.5	0	24																	
Pyrite	<2	<2			<0.01	2.8	0	2					0		0	2	0	7	0	0.7	0	2	0.00	7.00	
Kaolinite	<3	10	small amount		5	21.5	2	13	1	26			5	15	1	5	0	40	5	26	3	40	0.00	40.00	
Illite	25	60	dominant amount		7	20	4	21	5	42			10	20	3	15	0	40	2	40	10	50	0.00	60.00	
Mont - morillonite	2	25	small amount		3	29.5	3	18	2	34			5	20	5	43	0	10			10	50	0.00	50.00	
Vermiculite			none		7	20	2	4									0	15	2	16	-	-	0.00	20.00	

Table 2.1: Ranges of chemical and mineralogical compositions of clay raw materials applied in the brick and roof tile industry in different European countries

The particle size distribution, the other minerals present, the size range and ratio all fundamentally affect the properties of the clay.

The vast diversity in the composition of the raw materials results in a wide variation in the properties of ceramic products and in the gaseous emissions during firing. Each of these clays or mixtures of them, are used to produce roof tiles, facing bricks and extruded blocks. Most plants have their own clay quarry which contributes to the site-specific character of the production techniques used for the different types of products.

An analysis of fluoride and sulphur has been carried out since they effect the emission during firing as is discussed in Section 3.3.1.1 regarding emission data. Fluoride, present in the structure of clay minerals, ranges up to 1600 ppm throughout Europe and varies to a great extent in each country. As an example, the following figure shows a normal frequency distribution of the fluoride content in 312 samples of clays which come from all the geographical areas of Italy [3, CERAME-UNIE, 2003].

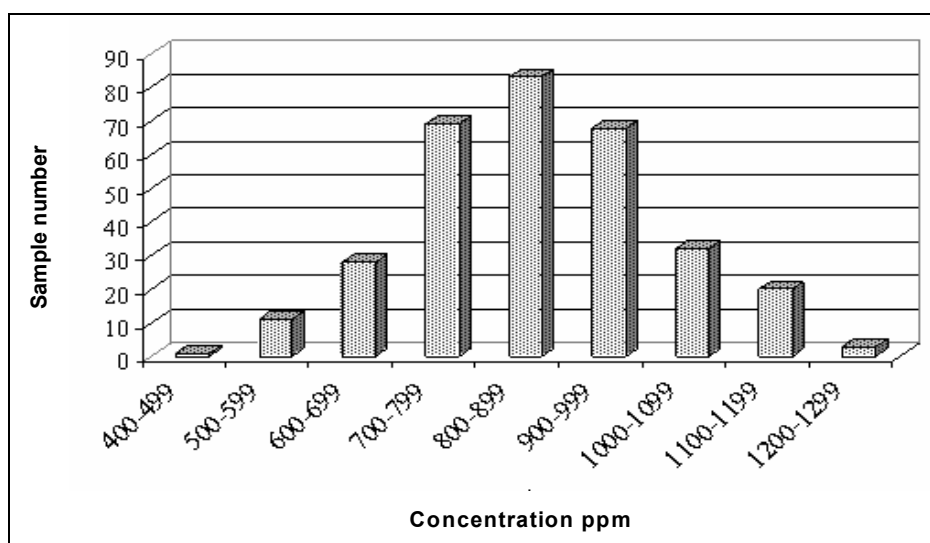

Figure 2.9: Distribution of fluoride content in Italian clays

Most of the clays contain trace levels of chlorine. The following figure shows an example of the distribution of chlorine content in Italian clays [30, TWG Ceramics, 2005].

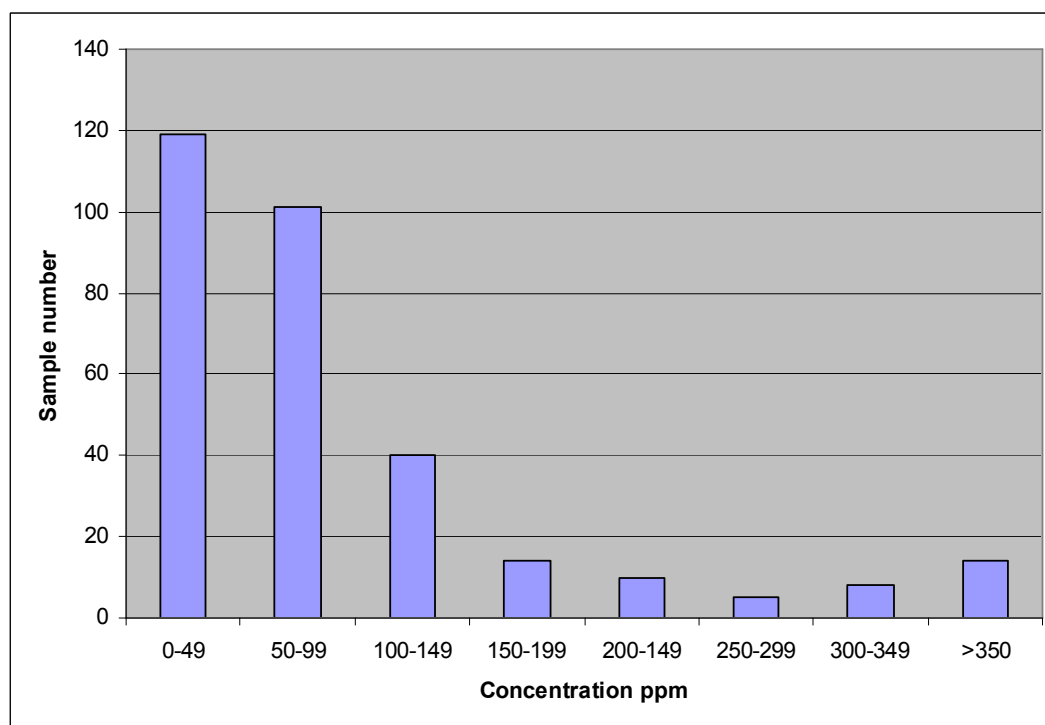

Figure 2.10: Distribution of chlorine content in Italian clays

The considerable variation of sulphur content in the raw materials being used, not only between the different European countries but also within one country, will result in large variations of process emissions. Sulphur mostly occurs as sulphides (pyrite) in the raw materials. Based on Italian research, sulphur shows a lognormal distribution, as shown in the following figure [3, CERAME-UNIE, 2003].

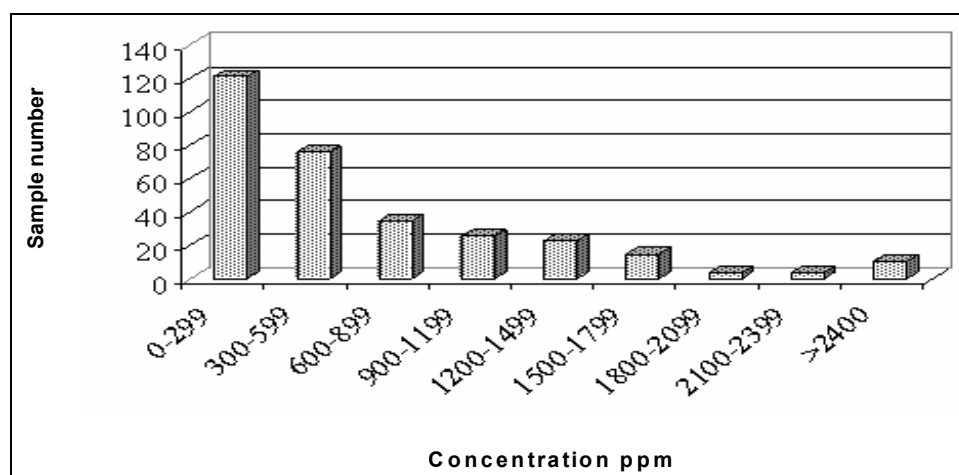

Figure 2.11: Distribution of sulphur content in Italian clays

Large variations are found not only in the magnitude of the sulphur content, but also in the sulphur content distribution. This is clearly demonstrated by the example of clays used in Germany, the United Kingdom and Belgium, as shown in the following figure. More than 80 % of the German clays have what is generally regarded as low and medium amounts of sulphur whereas in Belgium and the United Kingdom, more than 75 % are medium and high sulphur clays [3, CERAME-UNIE, 2003].

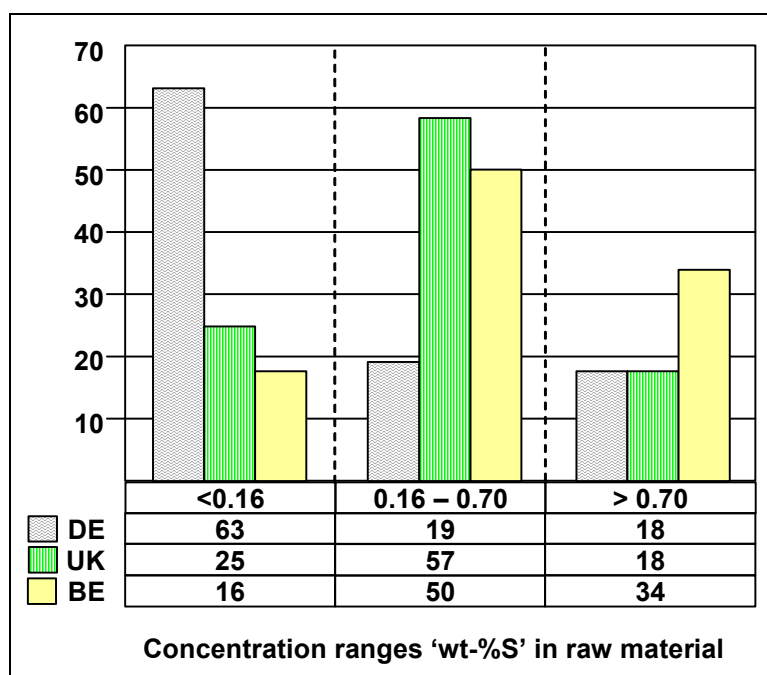

Figure 2.12: Sulphur content in clays

Another important material, where large variations are also found, is calcium oxide (CaO), mostly present as calcite and/or in the clay mineral structure. The presence of CaCO_3 acts as an 'opening agent' due to decarbonisation during firing. The release of HCl , SO_x and fluoride might be influenced by the presence of CaO due to the formation of CaSO_4 and CaF_2 . However, the concentration of fluoride, SO_x and HCl in flue-gases is not necessarily related to the level of CaO in the raw materials and also depends on the firing temperature and the presence of water vapour during the firing process [23, TWG Ceramics, 2005].

Organic compounds, phosphates and soda are used as plasticisers for argillaceous raw materials. Foamed polystyrene, paper binding agents, sawdust and inorganic materials such as kieselguhr and perlite are needed as pore-forming agents. Engobe, used for surface treatment, is often made of white-burning clay, fluxing agents or colouring oxides. Glazing consists of batch materials mixtures (e.g. Al_2O_3 , quartz flour, chalk, MgCO_3), fluxing agents, clay and colouring oxides or frits.

Raw materials are stored in the open air or in storage sheds, large volume feeders, tempering silos, ageing and souring facilities or dry material silos. In many cases, the brickyards are situated at close range to the quarries of the raw materials.

2.3.1.2 Preparation of raw materials

Dry preparation and semi-wet preparation are applied in the manufacture of tiles and bricks. The preparation method is selected because of the available materials, the quality specification of the final product, the method of shaping and the economic efficiency.

Dry preparation is mainly employed where relatively dry raw materials of lower plasticity are used or if high grade products are specified. The purpose of dry preparation is to reduce the particle size in hammer or suspended roller mills and to dry the particles to about three to six per cent water content at the same time. The necessary additives are also added in this process step, e.g. hydrated lime may be added to the clay (3.3 to 0.6 %) to regulate and fix the water content and to maintain a good plasticity in order to facilitate the cutting of the clay column in the extrusion-type process. Dry preparation is given preference in engineering or facing brick manufacture, because facing brick raw materials such as schistous clay have a low pit moisture level, making them particularly well suited for this preparation method.

A second preparation method in the manufacture of bricks and roof tiles is the semi-wet preparation process. Proportioning is carried out by large volume feeders. Volume feeders permit a bulk load and a proportion of several raw materials. In many cases, mixing water is added to the batch at the end of the feeder until the water content is around 20 %. Step by step crushing of the hard materials results in a maximum particle size of less than 1.8 mm. Thin products such as roof tiles have a particle size of between 0.5 and 0.8 mm. Depending on the characteristics of the raw materials, either clay crushers, knife crushers, double roll crushers or wet pan mills are used. Sand can sometimes be prepared and added separately; jaw crushers, impact crushers, vertical impact crushers and screens are used for this purpose. In some cases, sand and clay are stored separately and mixed just before shaping.

The combined processes of mixing and kneading bring about a homogenisation of the mass to obtain a good plasticity. A clay shredder, double shaft mixer, screen kneader and filter mixer are employed for this purpose. Organic and inorganic pore-forming agents are added in the manufacture of bricks with a low thermal conductivity to reach a large pore volume. In this process step, the mass receives the final shaping water content of 20 to 22 %. Hot water or hot steam supports the dissolving and opening up of small particles in the mixing process.

The prepared masses are stored in large volume feeders, clay silos, tempering silos, ageing and souring facilities for further homogenisation.

2.3.1.3 Shaping

Different shaping methods such as pressing, extrusion, and soft-mud moulding (see Sections 2.2.4.2, 2.2.4.3 and 2.2.4.4) are employed, depending on the kind of mass, the water content and the desired product.

In practice, the semi-wet prepared raw material is predominantly shaped in presses. The mass is pressed under a pressure of between 0.6 and 1.5 MPa in extrusion presses with or without a vacuum chamber. The die forms the mass into a column. The column is cut into single pieces by a wire cutter. This is the typical processing method in building brick and extruded roof tile production.

Pressed roof tiles are manufactured by forming so-called cakes or lumps first. Following this step, the cakes are shaped in another press to the correct geometry. Mechanical and hydraulic revolver presses, anvil presses, swivel beam presses and turntable presses are employed for this purpose. Single or multiple mould revolver presses are most commonly used. In revolver presses, an intermittently rotating drum in the form of a five, six or eight sided prism carries a bottom press mould on each of its sides. Each time the drum pauses, the vertical plunger, which carries the top mould, descends into the bottom mould located directly underneath and presses the clot of clay into shape. Following this step, the ware is placed on a special carrier. Different types of open moulds are used, such as plaster moulds, lubricated cast iron moulds, rubber lined moulds or metallic moulds with vulcanised rubber lining.

The visible surface of roof tiles is partially engobed or glazed. Bricks and facing bricks are treated by profiling, peeling, brushing or sanding to create surface textures.

2.3.1.4 Drying, glazing and engobing

Different types of dryers operate in the drying process (see Section 2.2.5), depending on the amount of work, the degree of mechanisation and the sensitivity of the mass. In the manufacture of bricks, chamber and tunnel dryers are usual. In the manufacture of roof tiles, chamber dryers and tunnel dryers are also used. In tunnel and fast dryers, the conditions for drying bricks are between less than 8 up to 72 hours at a temperature of approx. 75 – 90 °C. Fast dryers operate at significantly shorter periods of less than 8 hours for blocks, some facing bricks take up to 72 hours. In chamber dryers the drying period for bricks lasts up to 40 hours at a temperature of approx. 90 °C [23, TWG Ceramics, 2005], [30, TWG Ceramics, 2005]. Roof tiles are dried in tunnel dryers or chamber dryers at a temperature of 60 – 90 °C in 12 to 48 hours. The water content of the ware before the firing process in a tunnel kiln is lower than three per cent. Dryers are heated mainly by excess heat from the kiln and, in some cases, by natural gas or fuel oil burners or cogeneration.

Roof tiles and facing bricks are sometimes glazed and engobed on the visible surface or on the whole surface to achieve special colours or to increase the density of the product. Glaze and engobe are applied to the body after the drying process. In some cases, glazing and engobing is carried out after the shaping process. Engobe is a composition made of clay, fluxing agents, filling material and pigments. The best process to apply larger quantities to the ware is by spraying.

Organic binding agents are added to the engobe to achieve a better binding between the fluid engobe and the treated surface. Glaze is a mixture of batch material, fluxing agents, clay and colouring oxides, which are sintered to a vitreous mass. The glaze is usually applied by spraying in a spray chamber.

2.3.1.5 Firing

Today, bricks and roof tiles are fired in tunnel kilns mainly in an oxidising atmosphere. A reduction period in the final firing sector causes special colour effects if needed. In the reduction period, the fuel is supplied to an oxygen deficient atmosphere. In this way, the raw materials used generate the desired colour effects on the brick products.

The ware to be fired passes through the kiln on a series of kiln cars. Green bricks are placed directly on the tunnel kiln car, while green roof tiles are piled up for the firing process in the classic tunnel kiln in cassettes (H-form or U-form). The setting of the cassettes depends on the specific product to guarantee an optimal flow of the hot firing gases around the product and to consequently achieve a good firing result. The ware to be fired is heated up to a maturing temperature of between 800 and 1300 °C.

Following the necessary body formation time of between two and five hours at maturing temperature, the ware is cooled down according to plan to 50 °C.

The firing time of roof tiles in tunnel kilns is between 10 and 40 hours, paving bricks are fired, for 45 to 60 hours and clay blocks 17 to 25 hours. The flue-gas temperature depends on the dew point (and thus on the composition) of the flue-gas, e.g. for clays with a high sulphur content, the dewpoint will be higher and the flue-gas temperature will be higher. The following table shows ranges of operating data of classic tunnel kilns [4, UBA, 2001], [23, TWG Ceramics, 2005], [27, VDI, 2004], [21, Almeida, 2004], [30, TWG Ceramics, 2005].

Tunnel kilns	Unit	Facing bricks and clay pavers	Clay blocks	Horizontally perforated clay blocks	Roof tiles
Throughput	t/h	1 – 15	3 – 15	3 – 15	3 – 6
Kiln length	m	35 – 160	60 – 120	60 – 120	80 – 140
Cross-section	m ²	1.3 – 6.0	4 – 12	4 – 12	4 – 10
Setting density	kg/m ³	650 – 1500	350 – 500	250 – 750	200 – 400
Firing temperature	°C	1000 – 1300	900 – 1050	950 – 1050	1000 – 1150
Specific energy requirement (drying + firing)	kJ/kg	1600 – 3000	1000 – 2500 ^{*)}	1000 – 2500	1600 – 3500
Flue-gas volume flow	m ³ /h	5000 – 20000	10000 – 50000	10000 – 50000	10000 – 40000
Flue-gas temperature	°C	100 – 230	100 – 300	100 – 150	170 – 200

^{*)} Including heat content of the pore-forming agent

Table 2.2: Operating data of tunnel kilns

The fast firing method in roller hearth kilns is an alternative to the classic tunnel kiln firing technology. With the introduction of single rack flat firing for the manufacture of roof tiles, the firing time was reduced and the mass-ratio of firing auxiliaries to the ware to be fired was reduced. This method partially allows a reduction of the energy consumption in the firing process in some cases.

The fast firing method is performed in smaller kiln units – as opposed to the large classic tunnel kilns. The smaller units allow a greater flexibility in the adaptation of firing parameters to the actual product. The setting density of fast firing kilns can be below 100 kg/m³. The following table shows some data, referring to roof tiles, of classic tunnel kilns and fast firing methods [4, UBA, 2001].

Type of kiln	Mass-ratio firing auxiliaries/fired ware	Firing time (h)
Classic tunnel kiln	6:1	~50
Precision fast firing kiln	3:1	~10
Keramono single rack kiln	1:1	~2
Roller hearth kiln	0:1 to 2:1	3 to 8

Table 2.3: Comparison of classic tunnel kilns and fast firing methods (roof tiles)

The applicability of the fast firing method in the manufacture of bricks and roof tiles depends substantially on the specific surface of the product and the possibility of perfusion by hot firing gases. Not only roof tiles, but also clay blocks such as honeycomb bricks can be produced using the fast firing method. The following table shows ranges of operating data of fast firing tunnel kilns [4, UBA, 2001] [23, TWG Ceramics, 2005].

Fast firing tunnel kilns	Unit	Clay blocks	Facing bricks	Pressed roof tiles
Throughput	t/h	16.60 – 18.75	2.1 – 5.4	1.9 – 5.4
Kiln length	m	130	90 – 120	80 – 125
Cross-section	m ²	to 17.6	to 3.5	to 3.3
Setting density	kg/m ³	n.a.	n.a.	n.a.
Firing temperature	°C	1000	1000 – 1080	1020 – 1150
Firing time	h	2.5 – 3.5	4 – 5	3 – 4
Specific energy requirement (drying + firing)	kJ/kg	1250 – 3500	1590 – 4500	2930 – 4605

Table 2.4: Operating data of fast firing tunnel kilns

For the manufacture of specialised products, for example hand formed and special coloured facing bricks, Hoffmann kilns are also used. These consist of a series of linked chambers, which are sequentially filled with dried bricks, sealed, fired quasi continuously and the hot gases are drawn from one chamber to the next. This connecting system, with flues and holes between the chambers, also allows the preheating of the ware and the cooling of the flue-gases. One firing cycle takes usually between three days and two weeks and the setting densities in the linked chambers are more than 300 kg/m^3 . The kilns are now mainly gas fired, but top feeding with oil or coal is occasionally practised and produces bricks with ageing effects [17, Burkart, 2004], [23, TWG Ceramics, 2005].

Intermittent kilns can be used to produce specialised roof tiles, bricks or fittings, typically for smaller batches. Such kilns are operated discontinuously and have firing times of between 20 and 45 hours, firing temperatures of between 1000 and $1100 \text{ }^\circ\text{C}$, and specific energy requirements of around 500 to 900 kJ/kg [23, TWG Ceramics, 2005].

Classic tunnel kilns are mainly heated with natural gas or fuel oil, and fast firing kilns are heated with natural gas. In some cases coal, as mentioned above, petroleum coke and peat are also used.

2.3.1.6 Subsequent treatment

Depending on the result of the firing process, the products are sorted during the unloading of the kiln or the tunnel kiln car automatically or manually. Products such as calibrated bricks are treated in grinding machines.

Sometimes treatment of clay facing bricks, clay roof tiles or fittings with hydrophilic or hydrophobic agents (e.g. siliconising, lanolising) is applied, which changes the behaviour of their surface when wetted by water.

Roof tiles are packed and palletised for transportation to a shipping unit. A layer of paper, cardboard or wooden veneer is placed between each layer of tiles, and full pallets are shrunk in or wrapped in tight-pack film. The products are handled by forklifts, mobile and portal cranes.

2.3.1.7 Input and output flows in the manufacture of bricks and roof tiles

Important input and output flows of the brick and roof tile manufacturing process are presented in the following figure [4, UBA, 2001], [23, TWG Ceramics, 2005].

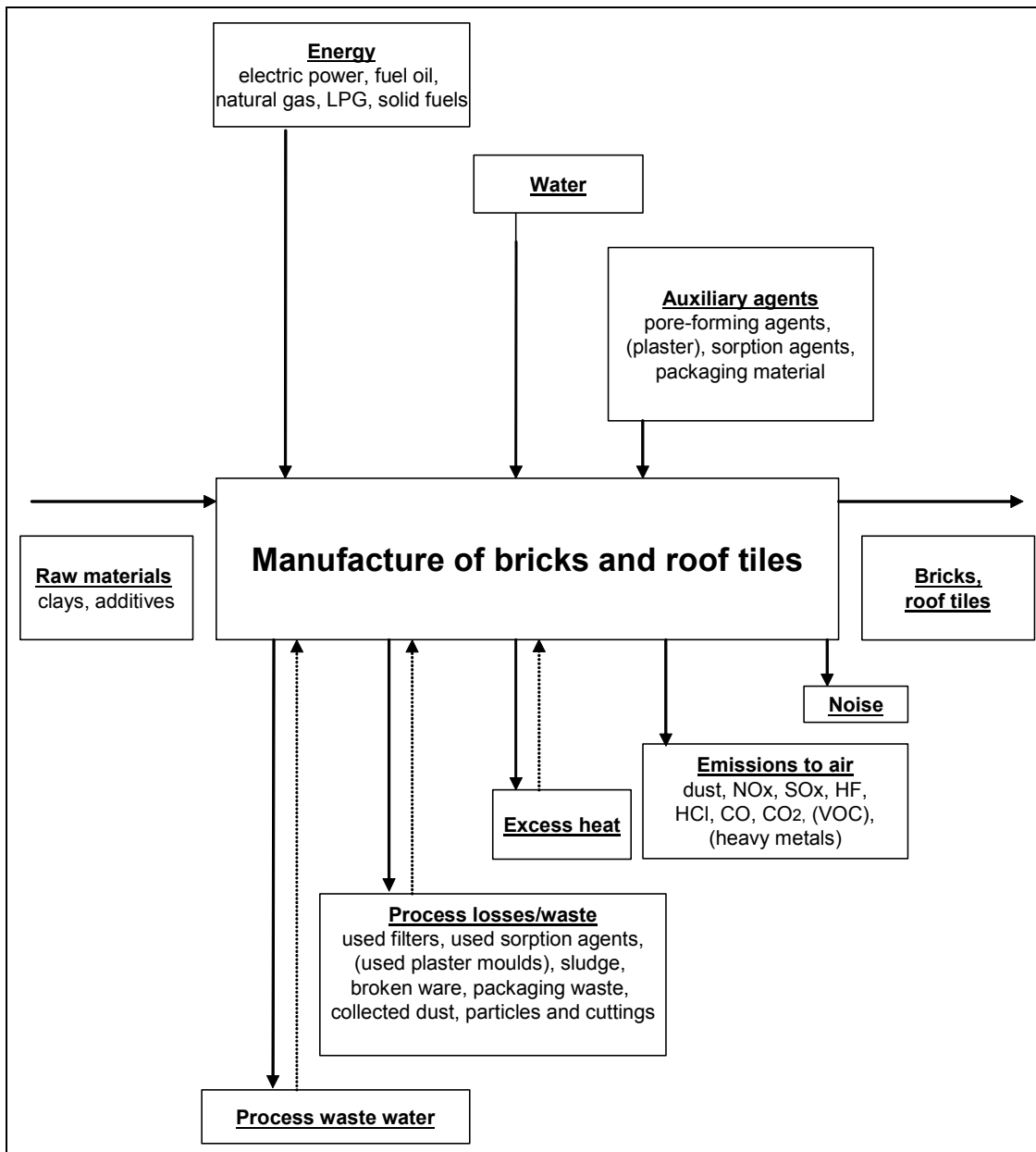

Figure 2.13: Input and output flows in the manufacture of bricks and roof tiles

2.3.2 Vitrified clay pipes

Vitrified clay pipes are manufactured using the following process steps: storage of raw materials, preparation of raw materials, shaping, drying, glazing, firing and subsequent treatment. The following figure shows a schematic view of the manufacture of vitrified clay pipes [4, UBA, 2001].

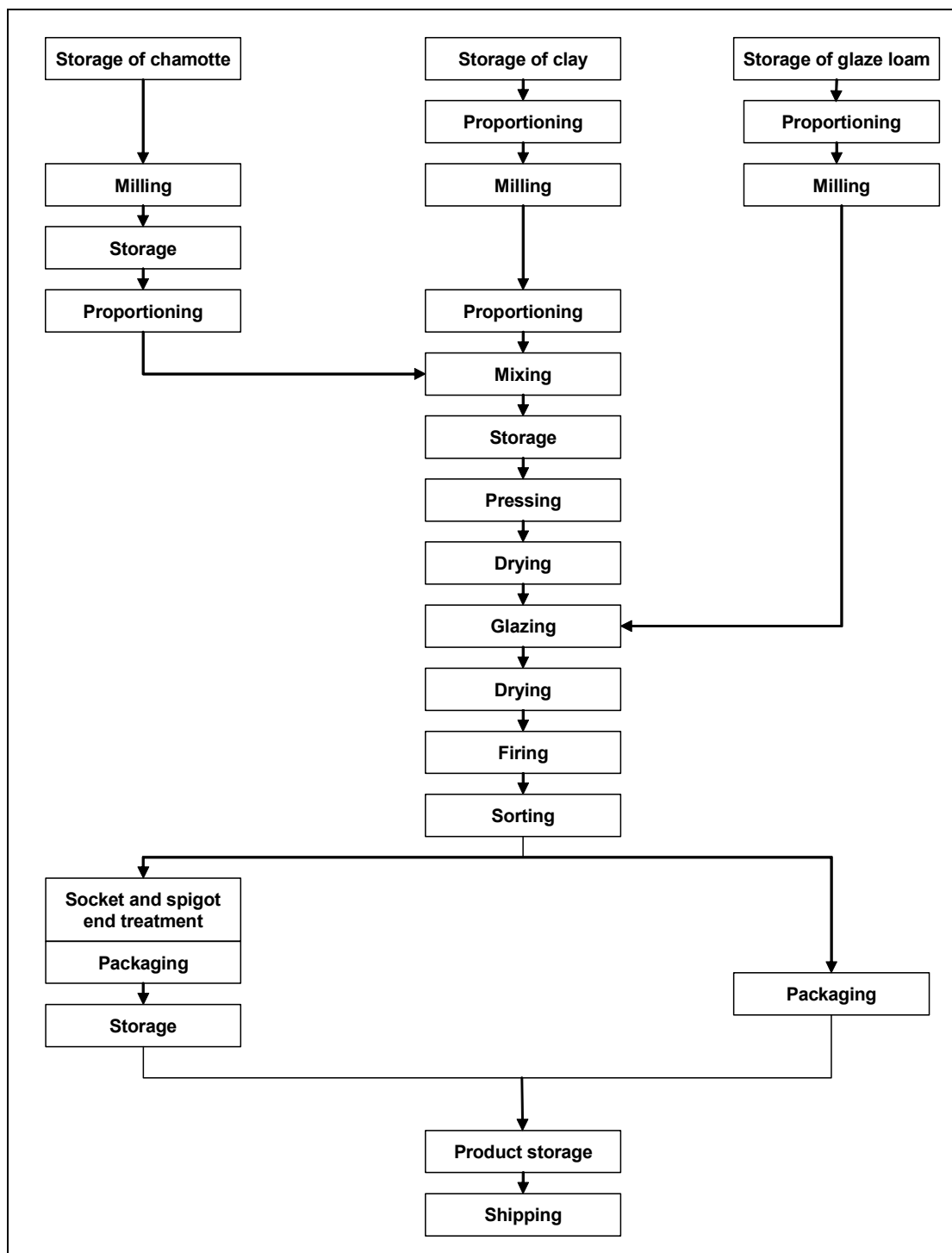

Figure 2.14: Schematic view of the manufacture of vitrified clay pipes

2.3.2.1 Raw materials

Clay, chamotte and glaze are employed as raw materials in the manufacture of vitrified clay pipes. Glaze consists of a mixture of loam, clay, chalk, dolomite, quartz and metal oxides. Chamotte raw materials, mainly consisting of re-used material from the ceramic production process, and loam for the glaze are stored under a roof. Depending on the preparation process, the clay components are stored in the open air or in boxes.

Table 2.5 and Table 2.6 show the ranges of mineralogical and chemical compositions of clays used in the manufacture of vitrified clay pipes [3, CERAME-UNIE, 2003].

Parameter (% weight)	BE	DE	IT	NL	UK
Quartz					
min	24	8	35	40	21
max	45	25	50	50	33
Feldspar					
min	11	1	1	0	0
max	18	4	24	0	0
Kaolinite					
min	24	30	5	20	8
max	32	60	20	25	20
Illite					
min	16	10	12	20	40
max	37	40	30	25	56
Montmorillonite					
min	0	2	0.5	0	0
max	8	10	1	0	0

Table 2.5: Mineralogical composition of clay in the manufacture of vitrified clay pipes

Parameter (% weight)	BE	DE	IT	NL	UK
S					
min	0.02	0.0	0.01	0.01	0.01
max	0.05	0.2	0.62	0.05	0.10
F					
min	0.03	0.02	0.04	0.02	0.02
max	0.05	0.06	0.13	0.04	0.05
CO ₂					
min	0.1			0.05	0.50
max	0.3			0.25	1.50
SiO ₂					
min	60	55	60	65	55
max	81	70	75	72	63
Al ₂ O ₃					
min	15	20	15	18	17
max	27	35	23	23	22
Fe ₂ O ₃					
min	1.0	1.0	5.0	1.5	6.0
max	7.4	10	7.0	4.5	8.0
MgO					
min	0.2	0.0	0.7	0.5	1.7
max	1.0	1.5	1.5	1.4	2.2
CaO					
min		0.0		0.2	0.3
max		0.8		0.5	0.6
Na ₂ O					
min	0.1	0.0	3.0	0.1	0.3
max	0.3	0.4	7.0	0.6	1.1
K ₂ O					
min	1.0	1.0	1.0	1.8	2.8
max	2.6	4.0	3.0	2.6	3.9
TiO ₂					
min	1.3	1.0	0.5	0.7	0.9
max	1.8	2.5	1.0	1.3	1.0

Table 2.6: Chemical composition of clay in the manufacture of vitrified clay pipes

2.3.2.2 Preparation of raw materials

Different processes are used for clay preparation, e.g. the slip process. The clay is passed in the required quantities by box feeders into the preparation process. Fine grinding is performed by different types of mills, e.g. wet drum mills and roller mills. Wet drum mills are also used for the fine grinding process of loam glaze components. The components are milled to a fineness of 0.06 mm. Following this step, coarser particles are removed by screening. The fine components are suspended in water and stored in stirred tanks.

Raw chamotte is crushed and milled in jaw crushers, cone crushers, beater mills or ball mills. The fraction with a maximum particle size of 2.5 mm is screened out and stored. Chamotte is used as an opener and provides the mass with the necessary strength and stability during firing. Clay and chamotte fractions are fed to the mixing unit gravimetrically via a conveyor belt and chamotte scales, or volumetrically by box feeders, belt feeders or rotary feeders.

In the mixing unit the components are mixed and watered to an approximate pressing moistness with a water content of between 15 and 20 %. Organic and inorganic pressing agents and plasticisers are added to the press mass if needed. The prepared, moist mass is stored and homogenised in large volume feeders, clay silos, storage sheds or ageing and souring facilities with adequate mechanisation.

2.3.2.3 Shaping

The green clay pipes are shaped in horizontal and vertical de-airing extruders. The press mass is compressed and de-aired in the de-airing chamber of the extruder followed by the shaping of pipe and the socket and spigot end. After this step, the socket and spigot end are cleaned.

The green pipe bodies are handled by special appliances such as vacuum adhering robots. The robots place the green ware on dryer cars. A speciality of the clay pipe shaping process is the stiffness of the press mass, the different pipe diameters and the periodically operated extruder.

2.3.2.4 Drying and glazing

The rupture-free drying of the green ware takes place in chamber or tunnel dryers at temperatures of up to 100 °C to about two per cent remaining humidity. The drying time of the fittings is between 70 and 100 hours, the drying time of the pipes is between 30 hours (small pipes) and nine days (large pipes). Climate control (temperature, humidity) is necessary to avoid distortion of the pipes by unequal shrinkage.

Suitable gripping and holding robots dip the dried green ware into the glaze tank to cover the bodies with loam glaze and also glazing by spraying is possible. In the firing process, the glaze merges with the body surface, encloses it and covers it with a smooth surface. If parts of the surface are not to be glazed, they have to be covered with paraffin before the glazing process.

The glazed green ware is set on tunnel kiln cars. Afterwards they are finally dried to less than one per cent remaining moisture in tunnel dryers, which are situated in front of the tunnel kilns.

2.3.2.5 Firing

Firing takes place in gas heated tunnel kilns predominantly in an oxidising atmosphere. The green ware is fired in a vertical position fixed on firing auxiliaries. Conventional firing temperatures are between 1150 and 1250 °C, the firing time is between 30 and 80 hours. The following table presents ranges of operating data of tunnel kilns used for the manufacture of vitrified clay pipes [4, UBA, 2001].

Tunnel kilns	Unit	Vitrified clay pipes
Throughput	t/h	1 – 6
Kiln length	m	80 – 180
Cross-section	m ²	6 – 10
Setting density	kg/m ³	150 – 300
Firing temperature	°C	1100 – 1200
Specific energy requirement (drying + firing)	kJ/kg	3000 – 4000
Flue-gas volume flow	m ³ /h	4000 – 18000
Flue-gas temperature	°C	160 – 200

Table 2.7: Ranges of operating data of tunnel kilns

An alternative to the conventional firing process is the fast firing method of vitrified clay pipes. Vitrified clay pipes are dried in ten hours and glazed by spraying. Then they pass through the kiln for a period of eight hours. The pipes are fired while they are moved by horizontal rolling. Fittings, e.g. branches and arcs, are also manufactured in the fast firing process. Similar to the fast fired pipes, they pass through the roller hearth kiln in a period of eight to eleven hours. Transport of the fittings takes place on special firing auxiliaries which are moved back in a cycle below the kiln.

2.3.2.6 Subsequent treatment

Following the firing process all products are inspected. Polymer seal elements or prefabricated seals are added to the socket and spigot end if necessary. After this step, the pipes and fittings are packed.

After attaching the seal elements, pipes with a certain dimension (DN 250 to DN 600) are treated by grinding to guarantee high precision of the socket and spigot ends.

2.3.2.7 Input and output flows in the manufacture of vitrified clay pipes

Important input and output flows of the vitrified clay pipe manufacturing process are presented in the following figure [4, UBA, 2001], [23, TWG Ceramics, 2005].

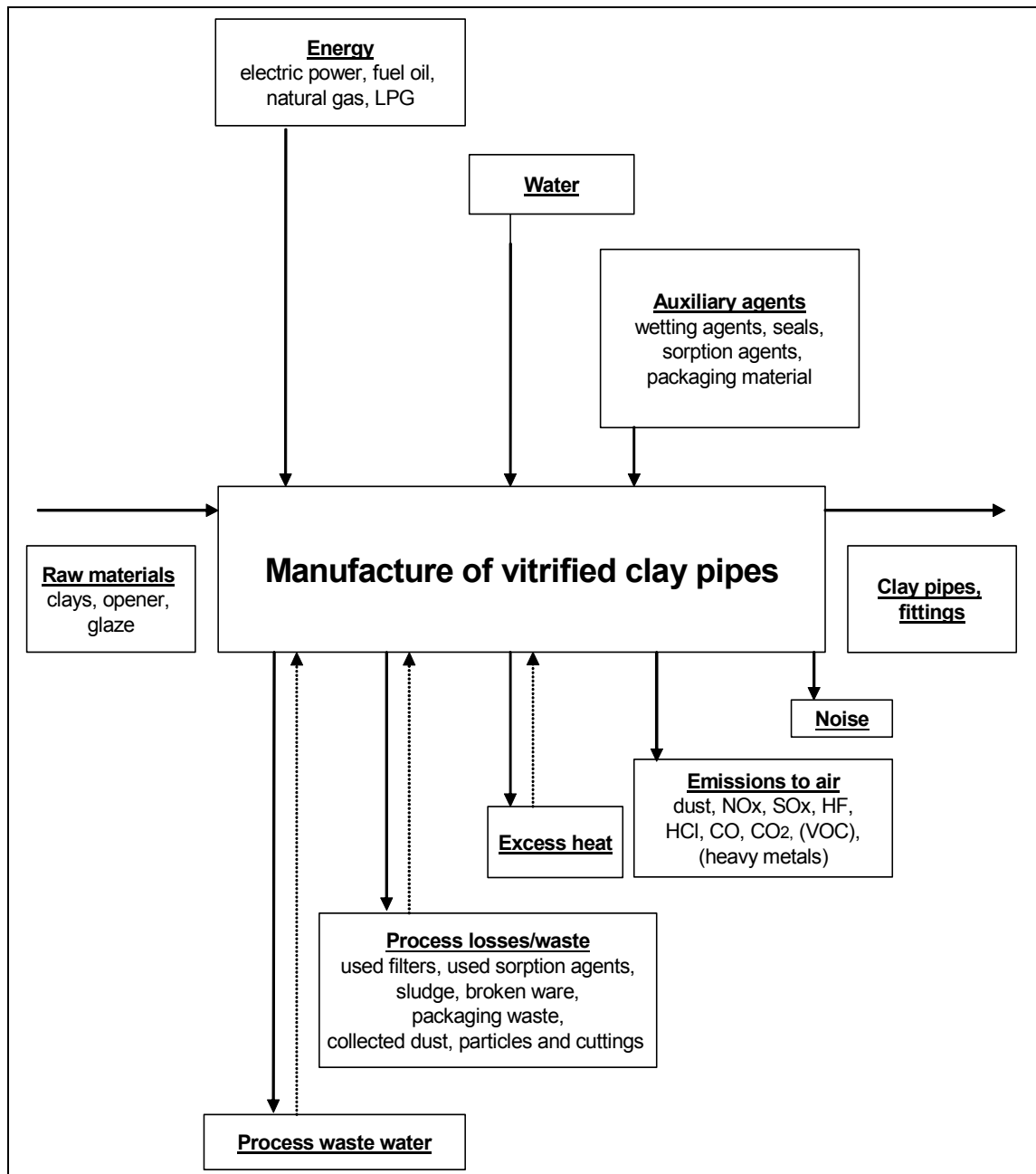

Figure 2.15: Input and output flows in the manufacture of vitrified clay pipes

2.3.3 Refractory products

Refractory products are classified according to their principal constituent. The main groups are:

- high alumina products, group 1 ($\text{Al}_2\text{O}_3 > 56\%$)
- high alumina products, group 2 ($45\% < \text{Al}_2\text{O}_3 < 56\%$)
- fireclay products ($30\% < \text{Al}_2\text{O}_3 < 45\%$)
- low alumina fireclay products ($10\% < \text{Al}_2\text{O}_3 < 30\%$, $\text{SiO}_2 < 85\%$)
- siliceous products or semi-silica products ($85\% < \text{SiO}_2 < 93\%$)
- silica products ($\text{SiO}_2 > 93\%$)
- basic products, based on magnesia, magnesia-chrome, chrome-magnesia, chromite, forsterite, dolomite
- special products, based on carbon, graphite, zircon, zirconia, silicon carbide, carbides (other than silicon carbide), nitrides, borides, spinels (other than chromite), fused-lime.

Various methods are employed by the refractory industry in the manufacture of bricks. The simplest procedure is to saw shapes from natural or artificially produced raw materials. Fusion cast products are manufactured by casting melts in moulds in order for the melt to solidify into blocks or bricks. Highly refractory materials are nowadays manufactured increasingly by fine crushing and wet mixing and afterwards the refractory materials are formed by means of extrusion, slip casting or isostatic pressing. However, the so-called heavy clay ceramic method is now preferred for the manufacture of refractory bricks. The production process passes the stages storage of raw materials, raw materials preparation, shaping, drying, firing and subsequent treatment. The following figure shows a schematic view of the manufacture of basic bricks containing chromium ore [4, UBA, 2001].

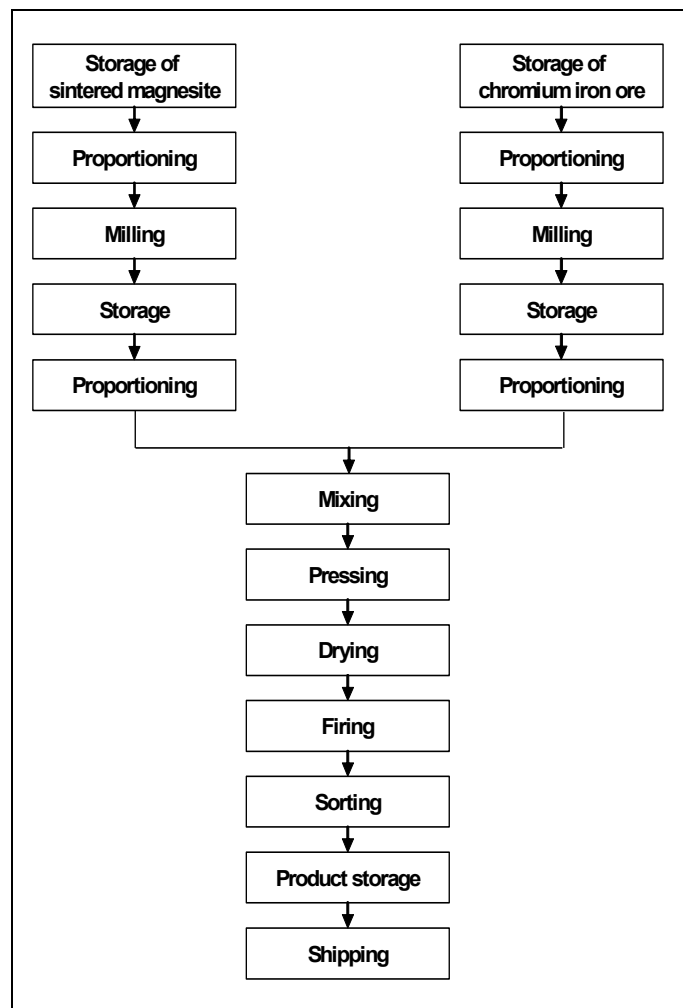

Figure 2.16: Schematic view of the manufacture of basic bricks containing chromium ore

2.3.3.1 Raw materials

Clay, chamotte and natural rocks such as quartzite, dolomite, magnesite and bauxite, which can be calcined (see Section 2.2.2.8), and also synthetic base materials such as, e.g. sintered corundum, silicon carbide, fused mullite or spinel, serve as raw materials for refractory products. In order to produce compressible masses, binders and aggregates are added to the milled raw materials. There are very different types of binders and aggregates used such as clay slip, sulphite lye, coal tar pitch, naphthalene, synthetic resin, milk of lime, wax, phosphoric acid, soot, graphite and sulphur. The raw materials are stored in roofed boxes. Pre-crushed delivered raw materials are stored in silos to avoid a reaction between water and raw materials.

The following table shows the most used oxides in melting/casting operations for refractory products with their corresponding melting temperatures [3, CERAME-UNIE, 2003].

Name	Formula	Melting temperature (°C)
Alumina	Al ₂ O ₃	2050
Chromium III	Cr ₂ O ₃	2275
Magnesia	MgO	2830
Dolomite	CaO + MgO	2700
Silica	SiO ₂	1725
Zirconia	ZrO ₂	2700
Zircon	ZrSiO ₄	1770

Table 2.8: Most used oxides in melting/casting operations

2.3.3.2 Preparation of raw materials

Raw materials are mostly crushed in a coarse and then a fine crushing process. Coarse crushing is performed by jaw crushers, impact crushers, roller crushers and cone crushers. Fine grinding is carried out in ring-roll mills, ball mills and vibratory mills. The crushed and milled raw materials are classified in different fractions by vibration screens. Oversized material is fed back to the milling units. The fractions are stored temporarily in silos, which are depots between the preparation step and the brick production. Proportioning is carried out using weighing scales. Binders, pore-forming agents, antitack agents and mould lubricants are added if necessary. The components are fed into mixers (mainly in periodically operated mixers), homogenised and pre-densified. Muller mixers, counterflow mixers and double shaft pug mills have proved satisfactory.

Casting slip is produced by mixing the raw materials with a dispersing agent such as water. 'Dust pressing powder' is manufactured in a dry process or in a wet or semi-wet process followed by spray drying.

2.3.3.3 Shaping

Casting slip and 'dust pressing powder' are employed in the shaping process. The casting slip is filled into moulds in the casting process. After adequate body formation time, the green ware is removed from the mould.

Formerly, 'dust pressing powder' was formed into the desired shape by toggle presses. These days, toggle presses have been replaced by hydraulically operated presses equipped with modern electronic control units. The presses continuously check the bricks and make adjustments if required. A specific press force of 80 to 200 MPa is standard today. Using the different press programmes, refractory bricks can comply with customers' requirements.

The isostatic pressing method has been accepted for the manufacture of high quality special refractory products. In this method, flexible plastic moulds are filled with a fine ceramic powder mix. After closing the mould, the mix is subjected to pressure usually in a hydraulic autoclave. The pressure is applied uniformly in all directions to the pressed shape via a compressive liquid, so that uniform densification is achieved. Pressures of up to 300 MPa are applied to manufacture large sized blocks and special shapes with this process.

Various grades of ceramic mixes can be compacted to shapes with relatively low pressure in conjunction with mechanical oscillations created by vibrators. Recently, the traditional shaping process has been supplemented by a new process. The mixes to be shaped are mixed with a binder sensitive to cold. Next the mixes are poured into moulds and harden at temperatures of below -30 °C.

2.3.3.4 Drying

The drying process takes place in chamber or tunnel dryers and lasts, depending on the size of the bricks, between one day and several weeks. Large shapes are dried under controlled humidity of the drying air. The remaining moisture should be less than one per cent before the firing process starts. The following table presents examples of operating data of periodically operated dryers, the significance of which is decreasing in the refractory industry [4, UBA, 2001].

Chamber dryers	Unit	Fireclay products	Silica products
Throughput	t/cycle	18	10
Drying chamber volume	m ³	171	56
Setting density	kg/m ³	105	180
Drying temperature	°C	80	100
Drying time	h	44	24
Specific energy requirement	kJ/kg	350	300
Flue-gas volume flow	m ³ /h	1600	15000
Flue-gas temperature	°C	60	60

Table 2.9: Operating data of periodically operated dryers (chamber dryers)

The following table shows the operating data of two tunnel dryers and a climate controlled dryer [4, UBA, 2001].

	Unit	Tunnel dryer	Tunnel dryer	Climate controlled dryer
Product		Fireclay	Magnesite	High alumina
Throughput	t/h	2.1	4	3.5
Dryer length	m	80	51	36
Cross-section	m ²	1.65	2.5	2.7
Setting density	kg/m ³	1000	1800	1000
Drying temperature	°C	100	150 – 180	30 – 200
Drying time	h	48	17	32 – 48
Specific energy requirement	kJ/kg	500	1500	n.a.
Flue-gas volume flow	m ³ /h	800	11000	5410
Flue-gas temperature	°C	40	120	105

Table 2.10: Operating data of two tunnel dryers and a climate controlled dryer

2.3.3.5 Firing

Refractory products are fired at temperatures of between 1250 and 1850 °C. Maturing temperatures depend on the composition of the raw materials and reach the beginning of deformation. The firing temperatures for the most important material groups are in the following ranges:

- fireclay bricks 1250 - 1500 °C
- silica bricks 1450 - 1500 °C
- high alumina bricks 1500 - 1800 °C
- magnesia bricks 1400 - 1800 °C.

The products are fired in tunnel kilns, shuttle kilns and hood-type kilns. The following table shows examples of operating data of tunnel kilns used in the refractory industry [4, UBA, 2001].

Tunnel kilns	Unit	Magnesia bricks	Fireclay bricks	Bauxite bricks	Silica bricks
Throughput	t/h	2 – 8	4	4	2.1
Kiln length	m	150	113	116	180
Cross-section	m ²	1.3 – 3	2.4	2.2	2.8
Setting density	kg/m ³	1000 – 2500	600 – 1500	600 – 1300	700 – 1000
Firing temperature	°C	1760 – 1850	1260	1400	1450
Specific energy requirement (drying + firing)	kJ/kg	6000 – 9700	3200	4500	9050
Flue-gas volume flow	m ³ /h	15000 – 25000	10000 – 15000	10000 – 15000	1200
Flue-gas temperature	°C	250 – 400	150 – 200	150 – 220	120

Table 2.11: Operating data of tunnel kilns used in the refractory industry

The following table shows examples of operating data of shuttle kilns used for firing silica, high alumina and fireclay products [4, UBA, 2001].

Shuttle kilns	Unit	Silica bricks	High alumina bricks	Fireclay bricks
Throughput	t/cycle	153	40 – 50	18
Firing chamber volume	m ³	180	20	25
Setting density	kg/m ³	850 – 1100	2000 – 2500	650 – 1000
Firing temperature	°C	1540	1340 – 1650	1430
Specific energy requirement	kJ/kg	4500 – 7000	4500 – 8000	7600
Flue-gas volume flow	m ³ /h	to 50000	to 20000	3600 – 7000
Flue-gas temperature	°C	180 – 300	180 – 290	160 – 250

Table 2.12: Operating data of shuttle kilns

The setting of bricks, especially in tunnel kilns, is performed increasingly by automatic setting machines. The bricks coming from the presses are automatically handled and placed on the kiln cars according to programmed setting patterns. The setting pattern permits impingement by flame and hot gases on all sides in conjunction with a low energy requirement. Modern kilns are operated with fuel oil and natural gas. In some cases, electric heating is standard for a short run of special products.

2.3.3.6 Subsequent treatment

In some special cases it is necessary for the fired refractory products to be subsequently treated by grinding, polishing and turning in wet or dry processes. Following this treatment, the products are palletised or packaged and covered with plastic foils to avoid any water soaking, because protection must be guaranteed for the entire transportation.

2.3.3.7 Special procedures

Special procedures are applied to manufacture refractory products with special characteristics. The formation of carbon bonding and pitch impregnation are procedures where special auxiliary agents are used. C-bonded bricks are predominantly used in the production of steel. The raw materials are often hot processed and pressed with coal tar, pitch or resins as binders. The bonding of the pressed parts is considerably reinforced by tempering and curing. The binding agent cokes during the tempering under the exclusion of air at temperatures of between 320 and 550 °C. During the hardening process, the products are heated to approx. 150 to 220 °C in electrical kilns. Refractory bricks are impregnated in some cases with coal-tar or bitumen to avoid ‘open pores’.

2.3.3.8 Input and output flows in the manufacture of refractory products

Important input and output flows in the manufacture of refractory products are presented in the following figure [4, UBA, 2001], [23, TWG Ceramics, 2005].

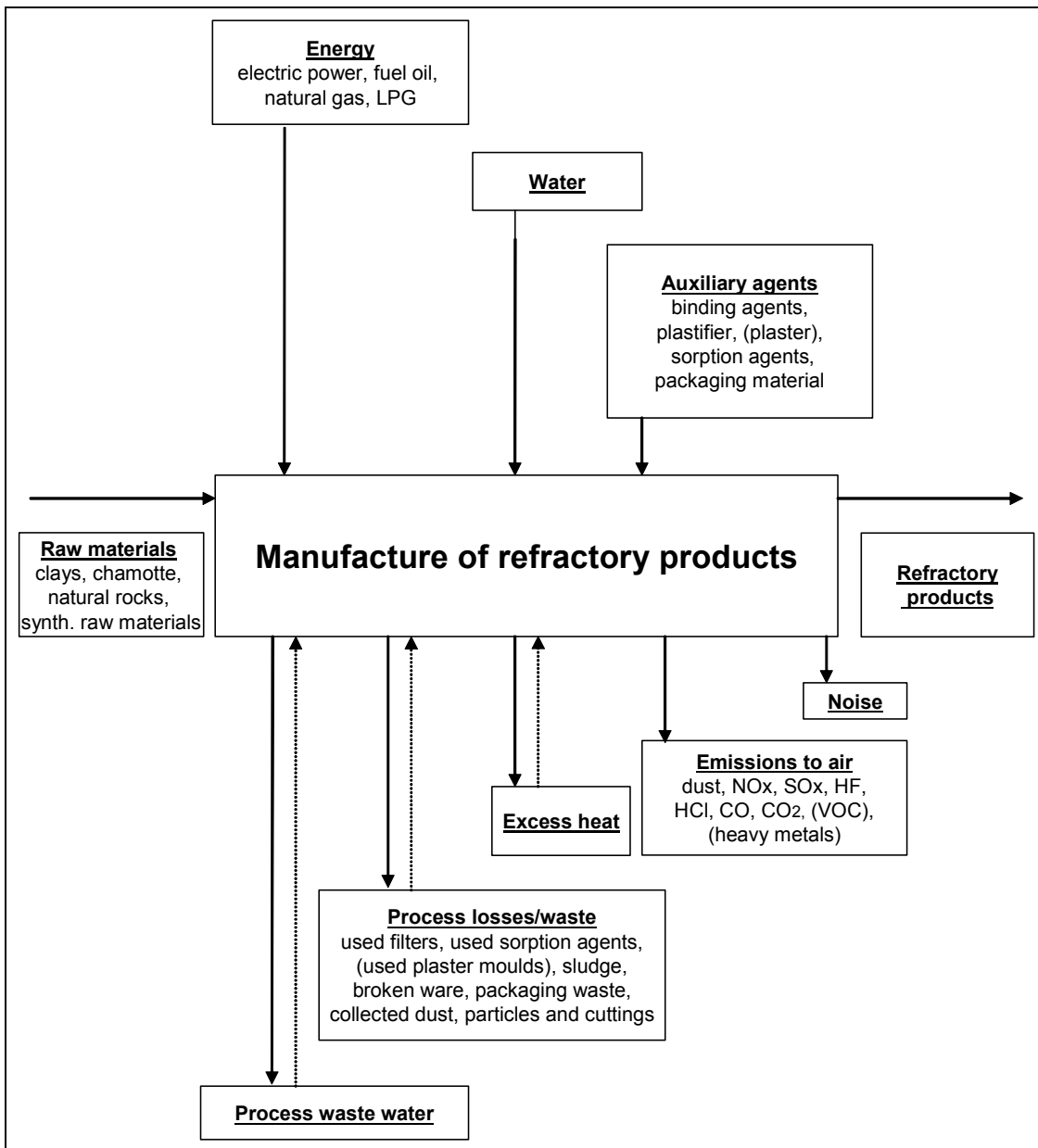

Figure 2.17: Input and output flows in the manufacture of refractory products

2.3.4 Expanded clay aggregates

Expanded clay is a porous ceramic product with a uniform pore structure of fine, closed cells and has a densely sintered, firm external skin. It is produced from raw materials containing clay minerals and additives. The raw material is prepared, moulded and then subjected to firing processes at temperatures of between 1100 and 1300 °C, resulting in a significant increase in volume due to expansion.

For the industrial manufacture of expanded clay, certain material requirements have to be met. Another important factor is kiln design, which should match the characteristics of the raw material and the quantities being processed. The following parameters can influence the expansion process:

- raw material composition
- additives
- temperature curve
- kiln atmosphere
- viscosity as a function of the above-mentioned influence factors.

Practical experience during expanded clay manufacture has shown that the expandability of clay is determined by raw materials and additives and by the thermal process technology. The main technological factors influencing the expandability of raw materials are the heating rate and the kiln atmosphere.

The manufacture of expanded clay involves the following steps: quarrying (this activity is not covered in this document), raw material preparation, shaping, heat treatment (drying, firing), subsequent product treatment, product recovery and preparation for transport (bagging, loading). The following figure shows a schematic view of the manufacture of expanded clay aggregates [26, UBA, 2005], [30, TWG Ceramics, 2005]. The shaping process step is not relevant for all plants

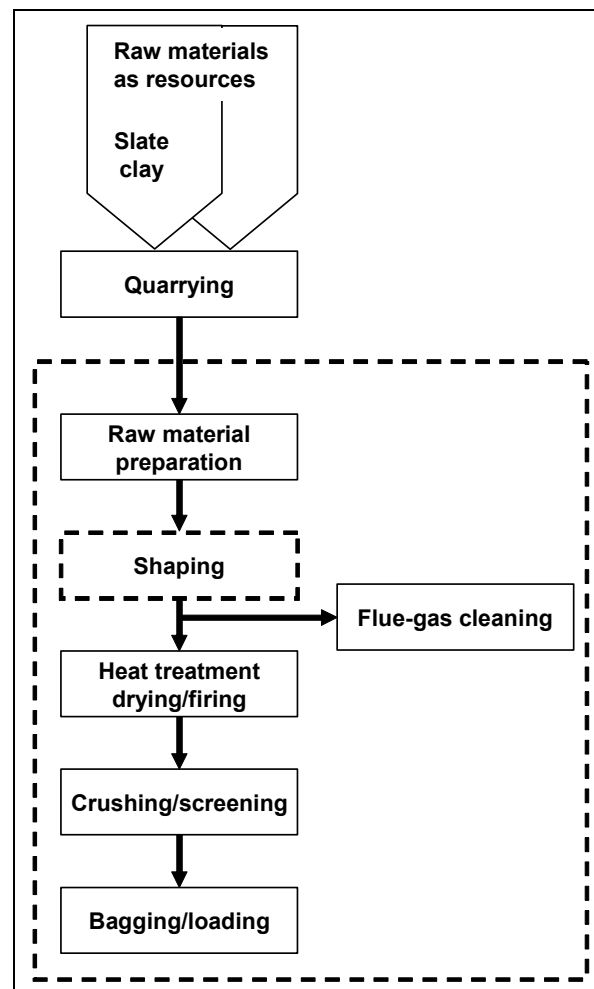

Figure 2.18: Schematic view of the manufacture of expanded clay aggregates

2.3.4.1 Raw materials, additives and auxiliary agents

Raw materials for the manufacture of expanded clays are early sintering clays. With a controlled heating rate and within a temperature range of between 1100 and 1300 °C, they experience a significant increase in volume. Only those raw materials that initially form a pyroplastic, dense sinter or melt coat when they are heated to these temperatures are suitable, and at the same time form gases inside the body (granule fragment) that are able to expand the viscous bodies. The presence of associated flux media such as iron oxides, alkalis, alkaline earths, as well as gas-forming substances that are either present in the raw materials or can be added during processing, are necessary for this to occur.

Previous studies showed that the expansion characteristics of a clay as raw material cannot generally be derived from analysis. Certain general statements regarding the chemical/mineral composition and other characteristics of materials with proven expandability are:

- relatively high plasticity, with a large fines content
- relatively high content of layered silicates, particularly from the illite or mica group, more than 40 % is advantageous; the kaolinite content is usually low
- calcite or dolomite content reduces the expansion time; lumpy lime is harmful, because it may subsequently lead to spalling
- chemical composition:
 - Al₂O₃: 12 – 25 %
 - SiO₂: 47 – 78 %
 - flux (Na₂O, K₂O, CaO, MgO, Fe₂O₃, FeO): 8 – 29 %
 - C_{organic}: 0 – 2.5 %
 - FeS₂: should be fine-grained (residue in the finished product ≤1.0 or 1.5 % SO₃)
- mineralogical composition:
 - quartz: 7 – 45 %
 - carbonates: 0.1 – 17 %
 - clay minerals: 40 – 80 %
 - feldspar: 5 – 25 %
 - other: 3 – 17 %
- pyroplastic softening of the mass or the granules should occur during the most favourable stage of the gas formation process; this offers the most advantageous expansion range of at least 50 to 100 K.

Clays that are naturally inadequate for expansion can be made expandable by adding appropriate additives and auxiliary agents, which make the manufacture of expanded products with special characteristics easier (for instance if the aim is to maximise the thermal insulation characteristics, expansion aids are often added to the expanded clay) and often also safer. The examples of additives (fluxes and release agents) and auxiliary agents (expansion aids) shown in the following table have proven to be particularly reliable:

Flux	Expansion aids	Release agents
Iron oxides	Heavy oils	Lime compounds
Iron hydroxides	Lignosulphonates	Dolomite
Illitic clays	Ultrafine coke/coal	
	Bituminous clays	

Table 2.13: Examples of expansion promoting additives and auxiliary agents

The types of additives and auxiliary agents depend on the composition of the raw material, the manufacturing process technology (processing of moist or dry clays, see Section 2.3.4.2), the economic availability and the characteristics of the emission. The dosage is usually between 0 and 10 % by weight.

2.3.4.2 General system and process technology

2.3.4.2.1 Shaping

Two basic techniques are used for the preparation of raw material and the shaping depending on the moisture content in the clay.

For clays with a relatively high moisture content, the use of the wet process is the most common technique: in mechanical processing and homogenisation in clay storage, pan mills, disintegrators, dual-shaft mixers and kneaders, the ductile clays (with additives) are fed to a rotary dryer. Through a suitable sequence of drying kiln fixtures such as chains, crossed bars and plates, the clay fragments are broken down further.

For rather dry clays, the use of the semi-dry process is the most common technique: a primary crusher is used for crushing large pieces of raw material to a grain size of less than 100 mm. The material can be homogenised during automatic storage and retrieved via a bucket-conveyer excavator. In the dry grinding unit, the raw clay is crushed between the rotating grinding track and grinding rollers. The powdered clay is fed to the slanting dish granulator, with water being added. The rotary motion of the dish causes spherical granules to form, which are discharged via the lower edge of the dish and the rolling movement has a certain granulating effect. Suitable reagents are added for reducing the surface tension of the added water. The size of the granules is influenced and their characteristics adapted to the respective raw material by changing the speed and inclination of the dish and the height of the dish edge. The granules pass through a 'powder drum', where limestone powder is applied to the granule surface. This prevents bonding of the unfired granules and subsequently protects them in the expansion kiln.

2.3.4.2.2 Thermal process technology

Trends in kiln design are characterised by efforts to develop systems with simple and flexible adaptability both in terms of the raw materials and the required product characteristics. One route for achieving this is variable firing and air control, combined with different transfer times for the individual thermal stages. The optimal temperature curve for reaching the desired density depends upon the raw material mixture and additives. For optimising the procedure, preheaters are located upstream of the actual expansion kiln. The most common preheater type is a drum preheater (drying kiln). For cooling, devices such as shaft coolers, rotary coolers, satellite coolers, grate or hopper coolers are usually used.

Rotary kilns used for the manufacture of expanded clay are usually operated in a counterflow mode, i.e. the material and the heating medium move in opposite directions. The raw material is added on the cold side of the kiln. Due to the inclination of the drum and the rotation of the kiln, the material drifts to the hot end of the kiln, i.e. the high temperature zone. The transfer time depends on the inclination of the kiln, its speed and the fixtures inside the kiln. Time has a significant influence on the product characteristics. In order to prevent the granules from sticking together, the kilns are sometimes equipped with appropriate fixtures such as suspended chains. The kiln dimensions vary depending on the technique used. Tube lengths vary between 4 and 80 m, diameters between 1.0 and 4.5 m. The common fuels used are oil, coal, gas and the alternative/secondary fuels are of organic origin (e.g. biofuels, biomass) and non-organic origin (e.g. waste oil, solvents). The system design aims to optimise the thermal balance, utilising a wide range of temperature and heating time options.

2.3.4.2.3 Chemical reaction during expansion

During the -heating of the granules, water vapour is formed from residual water, as well as oxygen, water vapour from constitution processes, decomposition gases from organic substances, sulphur dioxide and carbonic acid from carbonate. At the same time, the pores on the surface begin to close. The expanded product (with a more or less fine cellular internal structure) is formed due to the fact that the gases expand with increasing temperature. The main reactions occurring during expansion are the following:

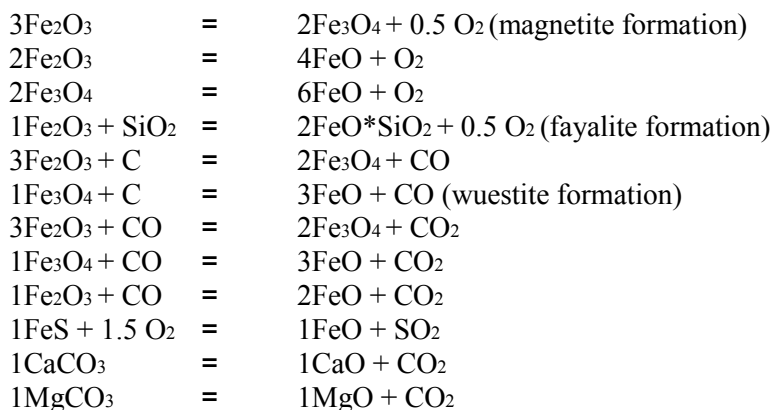

Consequently, the main gaseous elements and compounds that are released are therefore oxygen, carbon monoxide, carbon dioxide and/or sulphur dioxide, of which one or more have to be available for the expanding process. This principally occurs in the extended temperature range of approximately 750 to 1300 °C.

2.3.4.2.4 Subsequent sieving and crushing

In the manufacture of expanded clay aggregates, after the heat treatment process, the aggregates go through a sieving and crushing process to obtain the desired granulometry and quality. Dry sieving and sand crushers are normally used.

2.3.4.3 Input and output flows in the manufacture of expanded clay aggregates

Important input and output flows in the manufacture of expanded clay aggregates are presented in the following figure [17, Burkart, 2004], [23, TWG Ceramics, 2005], [26, UBA, 2005], [28, Schorcht, 2005], [30, TWG Ceramics, 2005].

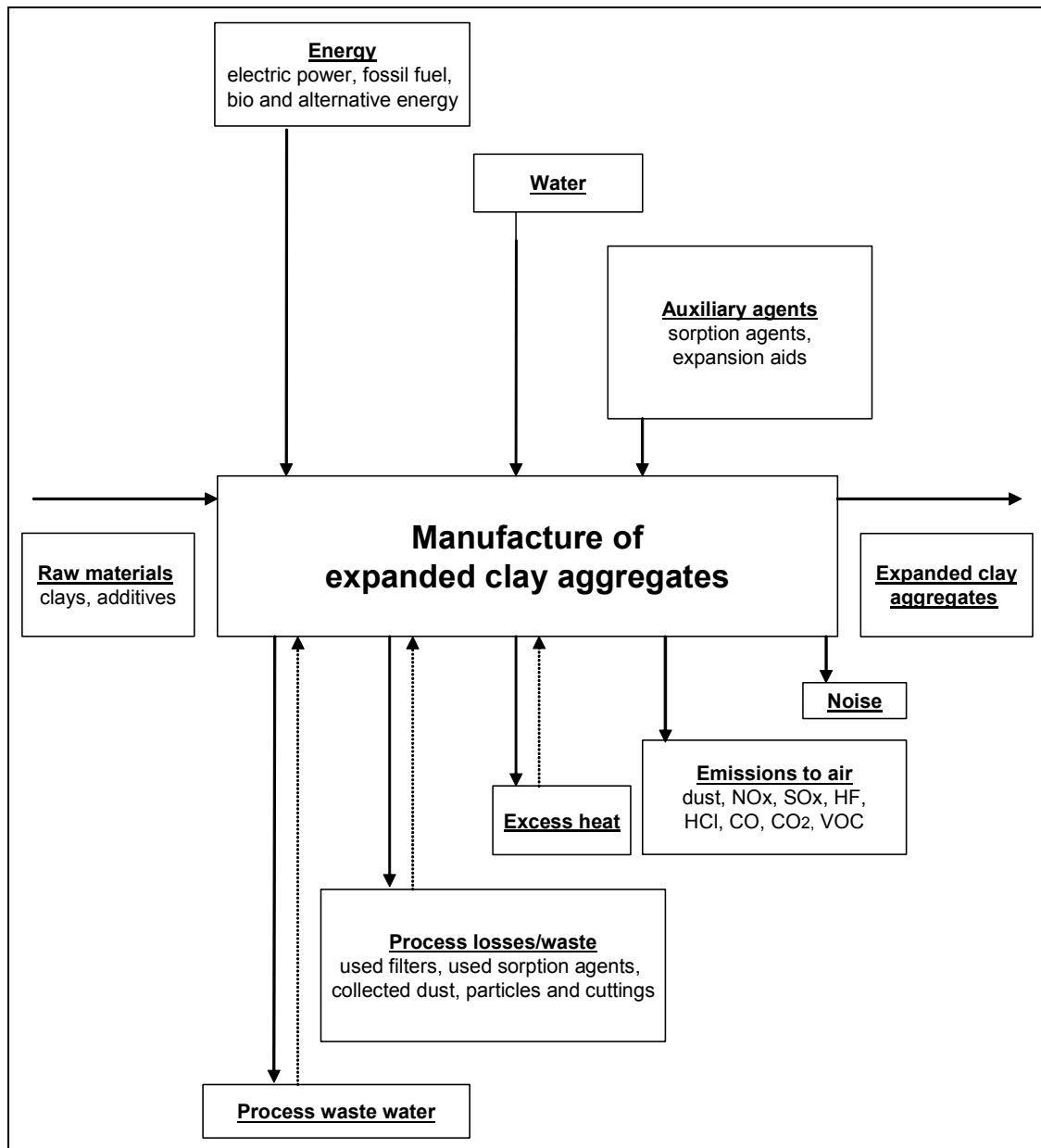

Figure 2.19: Input and output flows in the manufacture of expanded clay aggregates

2.3.5 Wall and floor tiles

The wall and floor tile manufacturing process consists of a series of successive stages which can be summarised as follows:

- storage of raw materials
- body preparation (dust pressing powder (dry or wet process) or extrusion paste)
- shaping
- drying of the green body
- glaze preparation and glazing
- firing (with or without glazing)
- polishing
- sorting and packaging.

Depending on whether the product to be made is glazed or not and whether single firing, double firing or third firing is involved, the tile will or will not be glazed in a given process, or the order of the glazing and firing stages will be suitably rearranged. The following figure shows a schematic view of the different possibilities for wall and floor tile manufacturing processes [3, CERAME-UNIE, 2003], [23, TWG Ceramics, 2005].

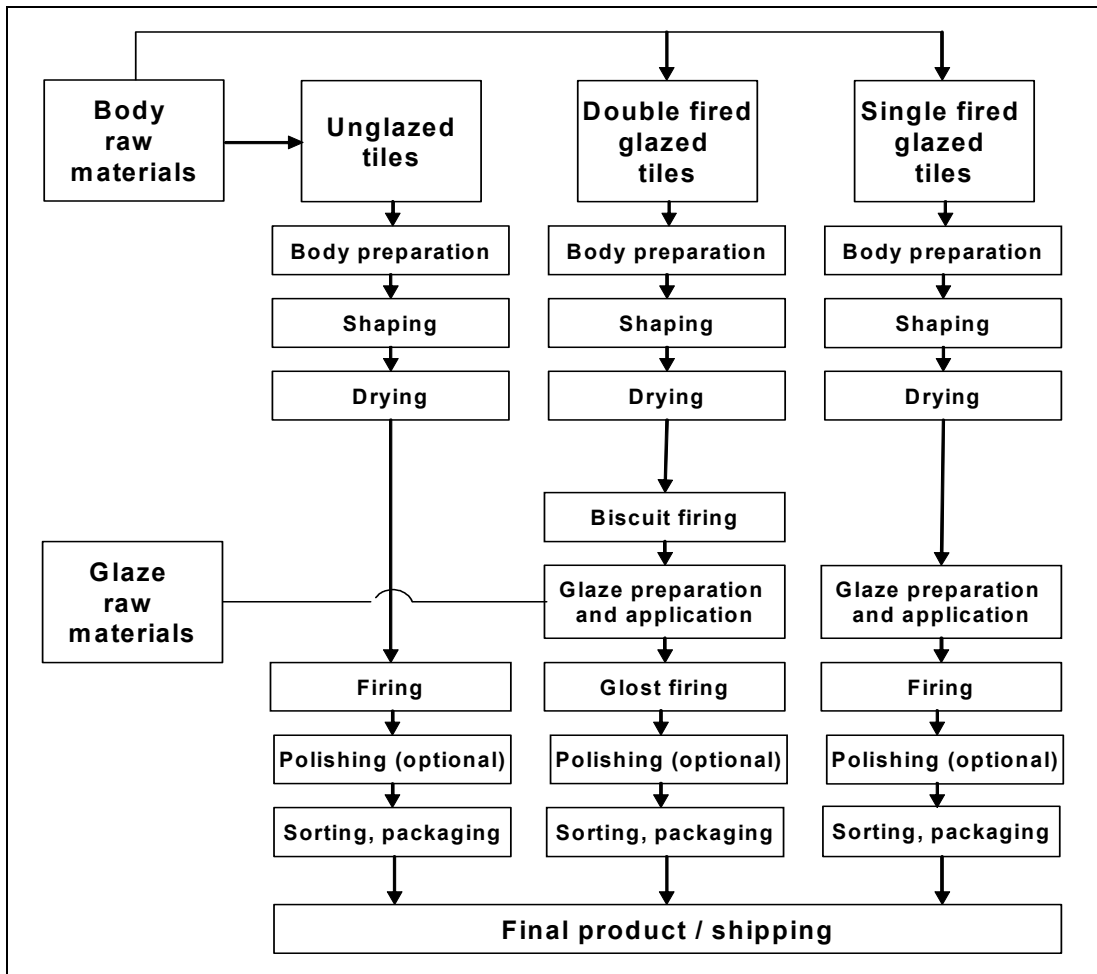

Figure 2.20: Schematic view of wall and floor tile manufacturing

2.3.5.1 Raw materials

Clays and kaolins are typical plastic raw materials used in the manufacture of wall and floor tiles. Chamotte, quartz, feldspars, calcium carbonate (calcite), dolomite and talc are non-plastic raw materials with different functions in the body composition (for instance feldspars act as fluxing agents, while calcite enables the formation of crystalline phases). The same raw materials combined with glaze frits, metal oxides and colourants are also used for glazes. Electrolytes such as sodium silicate or diphosphate are added to reduce the energy consumption in the drying process by water reduction.

Body components are delivered to the raw material storage area mainly as bulk material. The materials are stored in the open air, in storage sheds, boxes or silos. Smaller masses are delivered and stored in bags and containers, and fluid materials in closed tanks.

2.3.5.2 Preparation of raw materials

Preparation of raw materials includes different operations and techniques, according to the type or form of body to be produced.

The proportioning of raw material is performed gravimetrically taking into consideration the moisture of the raw materials. Small masses of pigments, metal oxides or colourants are added to stain the body components. Larger pieces are pre-crushed in roller mills or auger machines. After weighing, the pre-crushed materials are milled (including water and electrolytes) in wet drum mills, which may be batch or continuous mills. An additional variation is the elutriation and homogenising process of the batched raw materials in large tanks. The suspension is pumped from the tanks to wet drum mills. The water content of the suspension is about 35 %.

After fine grinding (to a particle size <0.1 mm), the suspension is screened step by step and stored in stirred storage tanks. The suspension is processed either to a plastic body ('extrusion paste') or to 'dust pressing powder'. The production and processing of casting slip is unusual in the manufacture of wall and floor tiles.

'Extrusion pastes' are usually prepared in pan mills or lamination units. To produce 'extrusion paste', the suspension is dewatered in filter presses or rotation filters to a water content of between 20 and 25 %. Organic or inorganic substances are added to the plastic compound to maximise the plasticity. These substances are, for example, alginate, dextrin, lignin, methyl cellulose, ethyl cellulose and paraffin.

A special process to prepare raw materials for plastic shaping is fine grinding in dry mills, mixing and then adding about 20 % of water (Buchta process) [23, TWG Ceramics, 2005].

Tiles are predominantly manufactured by the use of 'dust pressing powder'. Dust pressing powder can be produced through a wet or dry process.

In the wet process, the suspension is pumped from the stirred storage tanks by pumps to spray or flash dryers. Drying is performed at temperatures of between 350 and 450 °C to a water content of between five and nine per cent. The required heat in the spray dryer is produced by natural gas or fuel oil firing. Organic slip additives are added to maximise the sliding characteristic of the powder. The slip additives may be organic or inorganic; the most widely used additives in body composition preparation are sodium silicate, sodium tripolyphosphate and acrylates. The use of binding agents such as carboxymethyl cellulose, methyl cellulose, polyvinyl alcohol, etc. in body composition preparation is usually unnecessary due to their significant content in clays, except in special cases (e.g. big sizes) [23, TWG Ceramics, 2005].

The dry process includes dry grinding in cone, hammer and ring mills, followed by a suitable wetting of the ground powder, to achieve an average moisture content of around 5 – 7 %.

2.3.5.3 Shaping

'Extrusion paste' is shaped in an extruder to the right geometry and cut into pieces. Typical products manufactured from these plastic compounds are cleaving tiles. Earthenware and stoneware tiles are mainly made of 'dust pressing powder'. The powder is shaped to press bodies in impact toggle presses, screw presses or hydraulic presses with a pressure of about 35 MPa. Normally multi-tool presses, which are able to form four tiles per cycle, are employed. Pressed green ware is polished and put into the tunnel kiln car or roller dryer either automatically or manually.

2.3.5.4 Drying

The pressed bodies are dried mainly in tunnel dryers, roller dryers or vertical dryers. Waste heat from the kiln or natural gas and fuel oil firing burners are operated to heat the dryer. Drying is performed at temperatures that vary depending on the type of technology, e.g. in vertical dryers between 200 – 220 °C and in tunnel dryers 300 – 350 °C. Drying time is between one and four hours depending on the water content of the green ware. The required residual moisture content is less than one per cent to avoid fissures and glazing errors in the firing process.

2.3.5.5 Firing and glazing

Tiles are made as glazed or unglazed single fired products or as glazed double or even triple fired products. In the double firing process, the tiles pass the biscuit firing first. Biscuit firing is performed at temperatures of between 1050 and 1150 °C in classic tunnel kilns (in 20 to 50 hours) or in modern roller hearth kilns in one to two hours. Periodically operated kilns are used rarely in the ceramic biscuit process. Following this step, the tiles are sorted automatically and transported to the glazing process. Glaze is applied to the tiles by spraying or watering. Glazing machines are equipped with dabbing units to marble the tiles. Additionally, silk screen printing machines can be used for decoration purposes and decoration can also be carried out with gravure or flexography techniques. Glazing raw materials are often drawn as frits. All components in a frit are already batched, fired and milled. Substances such as lead are bound in frits in a molecular form, so water cannot wash them out in this process step.

The final firing takes place in roller hearth kilns, tunnel kilns or periodically operated kilns. Glazed tiles are put on firing auxiliaries and are fired at temperatures of between 1050 and 1300 °C in tunnel kilns or in roller hearth kilns without firing auxiliaries. Specially formed tiles are fired in shuttle kilns or tunnel kilns at temperatures of up to 1100 °C. The following table shows examples of operating data of tunnel kilns and roller hearth kilns.

	Unit	Tunnel kiln biscuit firing	Roller hearth kiln	
			final firing	single firing
Product		Tiles with higher water absorption		
Throughput	t/h	2.8	1.2	1.6
Kiln length	m	120	60	80
Cross-section	m ²	1.5 – 2.0	0.8 – 1.2	0.5 – 1.0
Setting density	kg/m ³	500 – 700	10 – 30	10 – 30
Firing temperature	°C	1100	1250	1300
Specific energy requirement	kJ/kg	3500	2900	2200
Flue-gas volume flow	m ³ /h	15000	10000	13000
Flue-gas temperature	°C	180	160	200

	Unit	Tunnel kiln	Roller hearth kiln	
			unglazed	glazed
Product			unglazed	glazed
Throughput	t/h	1.2	2.1	2.1
Kiln length	m	130	80	60
Cross-section	m ²	1.5 – 2.0	1.2	0.8 – 1.0
Setting density	kg/m ³	700 – 1000	20 – 30	20 – 30
Firing temperature	°C	1200	1220	1230
Specific energy requirement	kJ/kg	3900	2900	2500
Flue-gas volume flow	m ³ /h	15000	10000	13000
Flue-gas temperature	°C	220	160	160

Table 2.14: Operating data of tunnel kilns and roller hearth kilns

2.3.5.6 Subsequent treatment

After the final firing, some types of tiles (mainly unglazed porcelain stoneware tiles) can be ground or polished. Finally tiles are manually or automatically sorted, packed and palletised. The pallets are coated with a foil in a tight-packing machine.

2.3.5.7 Input and output flows in the manufacture of wall and floor tiles

Important input and output flows of the wall and floor tile manufacturing process are presented in the following figure [4, UBA, 2001], [23, TWG Ceramics, 2005], [30, TWG Ceramics, 2005].

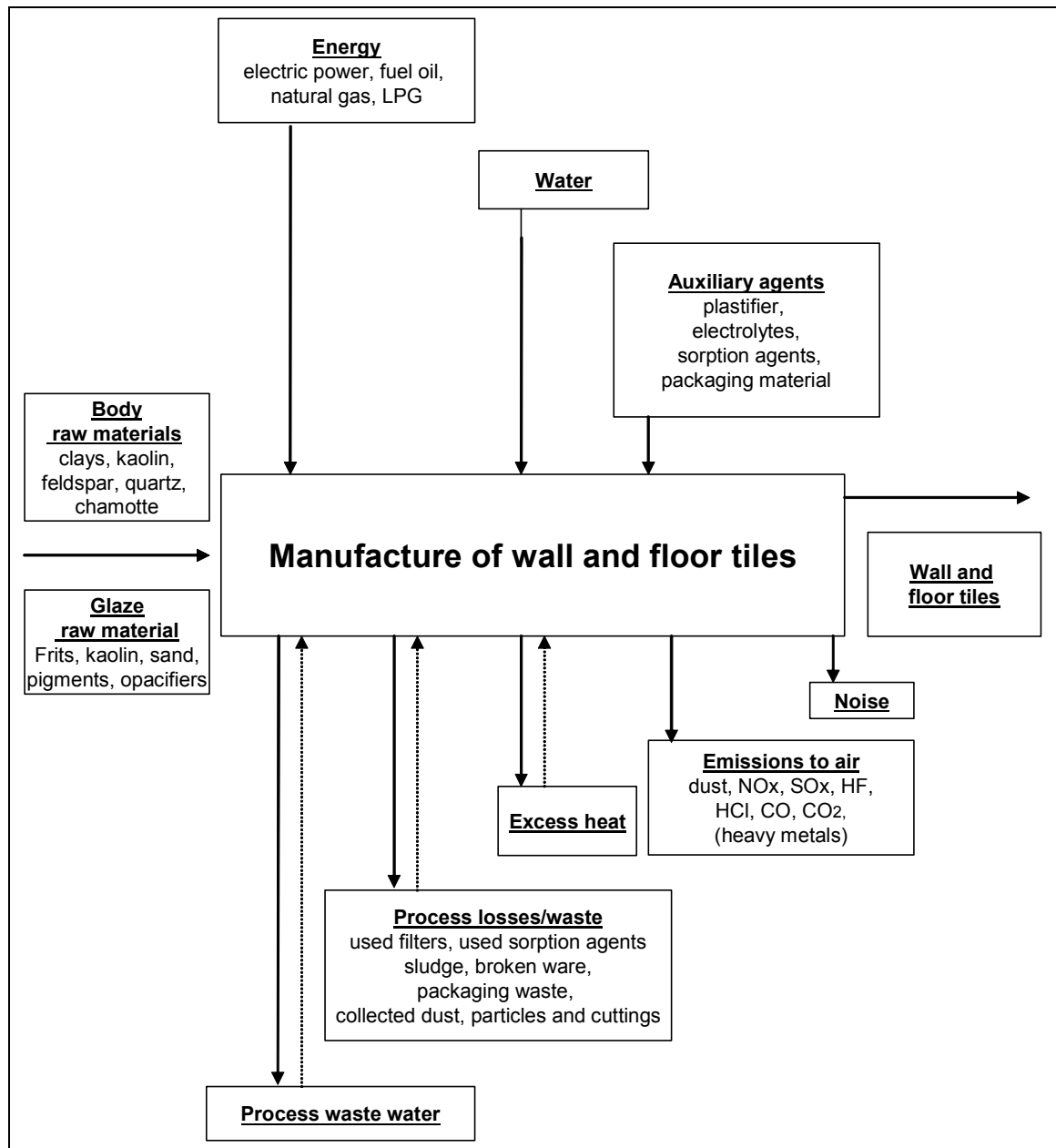

Figure 2.21: Input and output flows in the manufacture of wall and floor tiles

2.3.6 Table- and ornamentalware (household ceramics)

The process of household ceramics manufacture is made up of the following main steps: storage of raw materials, preparation of raw materials, shaping, drying, firing, glazing, decoration and subsequent treatment. As a typical example of household ceramics manufacturing, the following figure shows the stages of the manufacture of table porcelain [4, UBA, 2001].

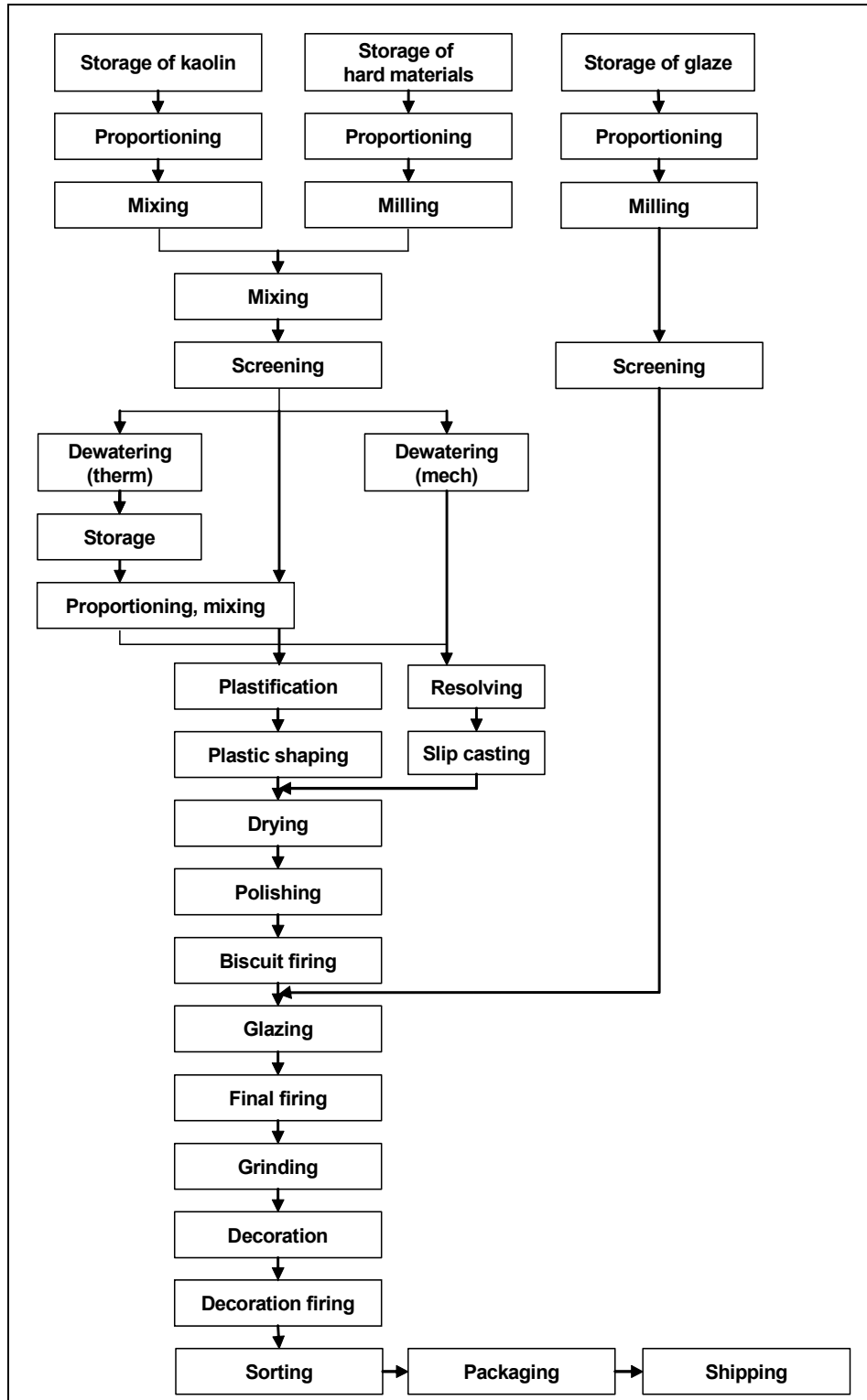

Figure 2.22: Schematic view of the manufacture of table porcelain

2.3.6.1 Raw materials

Plastic clays, feldspar and quartz are used as the main raw materials for the manufacture of household ceramics. The different compounds for the body batch and the glaze batch are delivered to the factory and are stored in silos, bags and containers depending on the moisture content of the raw material, the storage method and the particle size. To achieve a good body characteristic, several raw materials with different parameters are used.

Table 2.15 and Table 2.16 show typical ranges of the mineralogical and chemical compositions of raw materials used for the manufacture of household ceramics [3, CERAME-UNIE, 2003].

Mineral (%)	Earthenware	Vitrified	Porcelain	Bone china	Stoneware
China clay	25	25	55	25	0
Ball clay	15 – 25	25	0	0	0
Feldspar*	0 – 15	20	15	25	30
Talc	0 – 35	0	0	0	0
Silica	20 – 35	0	30	0	70
Flint	0	30	0	0	0
Bone ash*	0	0	0	50	0

*Nepheline syenite: normally an alternative to feldspar and bone ash

Table 2.15: Typical ranges of the mineralogical composition of raw materials for the manufacture of household ceramics

Mineral (%)	SiO ₂	Al ₂ O ₃	Other
China clay (kaolin)	55	35	10
Ball clay	75	20	5
Feldspar	70	20	10
Nepheline syenite	60	25	15
Talc	60	0	40 (MgO)
Silica	95	0	5
Flint	90	0	10
Bone ash	0	0	100 (Ca ₅ (PO ₄) ₃ OH)

Table 2.16: Typical ranges of the chemical composition of raw materials for the manufacture of household ceramics

2.3.6.2 Preparation of raw materials

The preparation of raw materials for the manufacture of household ceramics is performed in a wet or a dry process. 'Extrusion paste' and 'dust pressing powder' are predominantly produced. Body components are mainly metered gravimetrically. If kaolin compounds are dissolved in water, volumetric apportioning also takes place. In general, glazing raw materials are dosed gravimetrically. The plastic body compounds are suspended in water in stirred tanks to prepare the compounds for the mixing process. The following wet milling is performed in drum mills or in stirrer mills. Hard body compounds are often delivered with the correct particle parameters, so that no additional milling is necessary. Plastic body compounds and hard body compounds are mixed in stirrers or mixers. The compounds are screened to remove impurities followed by deferrisation which removes foreign iron compounds. Deferrisation is performed in electromagnetic fields. The body slip is dewatered mechanically in filter presses or thermally in spray dryers. For the production of 'extrusion paste', the water content of the slip is reduced from 65 % down to 20 to 25 % in filter presses or in rotation filters. The filter cake is homogenised and formed into clots in extrusion presses. For the production of 'dust pressing powder', the slip cast is dewatered down to 5 to 8 % water content in spray dryers. The slip cast is pumped into the spray dryer by a special slip cast pump. The water content is reduced by a hot gas stream. The flue-gas of the gas heated dryer and the vaporised water leave the dryer at the top.

Organic slip additives and binding agents are added to the 'dust pressing powder' to achieve soft and slide characteristics of the powder. Carboxymethyl cellulose, methyl cellulose, cellulose ether, polyvinyl alcohol, polyvinyl acetate and polysaccharide are used for this purpose. Olein, mineral oil, stearic acid and wax are added. The share of slip additives and binding agents in the 'dust pressing powder' is between 0.2 and 0.4 wt-%. 'Dust pressing powder' produced in the fluidised bed process can be used with a reduced share of slip additives and binding agents thus providing better deformation characteristics.

Fluidised bed granulation on the one hand and non-thermal granulation processes on the other hand, are future alternatives in the production of 'dust pressing powder'. The specific energy consumption of fluidised bed granulation is higher than in the normal spray drying process but the specific thermal energy consumption is lower.

If 'extrusion paste' for soft plastic shaping is produced by the use of 'dust pressing powder', the powder and returning slip cast is mixed until the water content is about 20 to 25 %. The extruded cylindrical sections are stored for some time to guarantee even moistness and tension. Organic additives and agents and inorganic binding agents such as magnesium chloride, magnesium sulphate, phosphate or borax are used to increase the strength of the plastic compounds for soft-plastic shaping.

Filter cake, waste from plastic compounds for hard-plastic shaping or 'dust pressing powder' are dissolved in water to produce casting compounds (casting slip). The water content of the casting slip is between 25 and 35 %. To ensure a good slip characteristic, even with lower water contents, additives such as soda, sodium or potassium silicate, caustic or humic acid are used.

2.3.6.3 Shaping

There are three different types of shaping processes in the manufacture of household ceramics. Flatware such as plates and dishes are predominantly manufactured in the dry pressing process. Hollow wares, e.g. vases, are manufactured in the casting process, while cups and jugs are manufactured in the plastic shaping process.

In the dry pressing process, 'dust pressing powder' (water content of around 5 %) is pressed isostatically with auxiliary agents. The 'dust pressing powder' is filled into a press. The press consists of an upper and a lower part. In the lower part, the isostatic membrane works as the main part of compression. Depending on the product, the upper part of the press is designed in various shapes. Horizontal presses using multi-form heads are able to produce various products with a high output. Double head presses produce up to 1200 pieces per hour. The powder is pressed into the form with a pressure of 30 MPa. The advantage of this process is the low water content of the green ware.

In the plastic shaping process, the 'extrusion paste' (water content of between 20 and 25 %) is formed in jiggering machines with the aid of profile tools. Dynamically balanced goods are produced in plaster moulds, which are manufactured in special facilities. The cylindrical plastic body is cut in similar slices. In the next step, the slices are mechanically apportioned to the plaster moulds of the jiggering machines. The lifetime of the plaster moulds is very short. Plaster moulds are often used for only a 100 to 150 pieces. Recently, porous moulds made of polymer materials have been employed to achieve a longer lifetime.

Non-dynamically balanced goods are produced in the slip casting process. Body formation takes place by dewatering the slip cast in plaster moulds. The solid casting process is used mainly for the production of flatware. Vases and jugs are manufactured in the drain casting process. Casting machines are used for manufacture on an industrial scale. Production on a small scale is carried out by hand-casting. The body formation time can be reduced under pressure. Pressure casting takes place in porous polymer moulds under pressures of up to 4 MPa. Pressure casting is much faster than the conventional casting process, so that the casting cycles last for two or three minutes only.

Plastic pressing is an additional process used for the manufacture of household ceramics. Goods are manufactured in two-part plaster moulds or polymer moulds. Compared with the slip casting process by using a plastic body, this process reduces the body formation time considerably.

2.3.6.4 Drying

Goods produced in the slip casting process or in the plastic shaping process have to be dried in special dryers to a water content of less than two per cent. Chamber and tunnel dryers heated with kiln waste heat, natural gas or fuel oil EL is used for this dewatering. Infrared dryers and microwave dryers are an alternative to the conventional drying process. These dryers are employed for the pre-drying of the casting compounds and also for the drying of used and new plaster moulds. Microwave dryers are built as chamber, tunnel and chamber-passage dryers.

Surface roughness and mould marks resulting from the shaping process are removed in the dressing process. Dressing is carried out with knives and by subsequent treatment with a wet sponge rubber. Pressed and jiggered goods are cleaned predominantly by machines, other goods are treated manually. For manufacturing on an industrial scale, the shaping, drying and dressing processes are united in one stage of manufacture.

2.3.6.5 Firing, glazing and decoration

Household ceramics are fired between one and four times, depending on the material and the production technique. In the first step, biscuit firing gives the semi-product the strength and absorbency needed for the glazing. Biscuit firing temperatures are between 900 and 1050 °C, the firing time in classic tunnel kilns is between 18 and 30 hours. Fast firing kilns achieve firing times of between three and seven hours.

Glazing follows biscuit firing. The glaze consists of glassy compounds with a higher share of fluxing agents dispersed in water. Hollow goods (except for cups) are glazed by manual dipping. Flatware and cups are glazed mechanically in a pouring-glazing process, whereas small scale production is glazed manually by dipping. Flatware is also glazed by spraying. Adhesive agents (for example polyamine or dextrine) are used as organic binding agents and glues. Electrolytes are mixed with the glaze to achieve faster drying.

The glost firing that follows is performed in an oxidising or reducing atmosphere at temperatures of between 1320 and 1430 °C. Glost firing kilns are tunnel kilns with tunnel kiln cars, (multi-rack) roller hearth kilns, fast firing tunnel kilns with moving firing tables, slab kilns or belt conveyer kilns. Periodic kilns such as chamber kilns, shuttle kilns and hood-type kilns are operated at lower feed rates. The ware to be fired is set on fireproof firing auxiliaries (so called 'kiln furniture'). Glost firing time varies between 25 and 36 hours in the tunnel kiln and between three and a half and five hours in fast-firing kilns without firing auxiliaries.

Table 2.17 and Table 2.18 show examples of operating data of periodically and continuously operated kilns [4, UBA, 2001].

Shuttle kiln	Unit	Porcelain
Throughput	t/cycle	0.91
Firing chamber volume	m ³	7.0
Setting density	kg/m ³	12.8
Firing temperature	°C	1400
Specific energy requirement	kJ/kg	20000
Flue-gas volume flow	m ³ /h	12500
Flue-gas temperature	°C	800

Table 2.17: Operating data of a shuttle kiln

Tunnel kilns	Unit	Porcelain		Porcelain	Porcelain
Firing		Biscuit	Glost	Glost fast	Glost fast
Throughput	t/h	0.3 – 0.7	0.2 – 0.4	0.58	0.47
Kiln length	m	60 – 100	80	70	56
Cross-section	m ²	0.5 – 1.0	0.5 – 1.0	0.7	0.94
Setting density	kg/m ³	60 – 70	60 – 70	<100	<100
Firing temperature	°C	850 – 1260	1200 – 1400	1420	1420
Specific energy requirement (drying + firing)	kJ/kg	25000	20000	12500 without drying	19700
Flue-gas volume flow	m ³ /h	3500 – 5000	3500 – 5000	n.a.	n.a.
Flue-gas temperature	°C	120 – 170	120 – 170	n.a.	n.a.

Table 2.18: Operating data of tunnel kilns

The glaze melts during the firing process and seals the porous ceramic body. The surface becomes watertight and smooth. After the glost firing, the goods are divided into corresponding quality grades. Areas with no glaze are ground and polished to maximise the value of the products.

Bone china is a speciality for traditional tableware and tea services. Important raw materials for bone china are Cornish clay, Cornish stone and up to 50 % calcined bovine bones. The gloss firing temperatures are between 1250 and 1350 °C, and biscuit firing temperatures are between 1100 and 1150 °C. A kiln atmosphere with glaze vapour ensures a very smooth surface.

The decoration process which follows, maximises the value of the product and permits customisation. On-glaze colours, in-glaze colours, under-glaze colours and metal compounds are used for the decoration. In the on-glaze decoration process, glazed and already fired goods are decorated. On-glaze decoration is melted into the glaze by an additional firing process. In the in-glaze decoration process, the coloured pigments sink into the glaze. In the under-glaze decoration process, the goods are decorated before the glazing process starts. Typical decoration processes are the slide-off transfer, reprinting, direct silk screen printing, offset printing, lining, banding, stamping, powdering, painting, spraying, stencilling and etching. Besides manual decoration, machines for silk screen printing and coloured printing are employed. Numerous oxides are set in as fluxing agents, opacifiers and for direct colouring in the glazing and decoration processes. The glaze and decoration colours consist of complex systems of numerous pigments. In the following list, the elements and their chemical valence (in brackets), in which they appear as oxide compounds in the pigments, are mentioned: Cu (1, 2), Ca (2), Zn (2), Al (3), In (3), Si (4), Sn (4), Pb (2), Ti (3, 4), Zr (4), Ce (4), Pr (4), V (4, 5), Sb (3, 4, 5), Cr (3, 6), Mo (4, 6), Mn (2, 4), Fe (2, 3), Co (2), Ni (2) und Cd (2).

In addition to the decoration process, examples of operating data of different kilns are presented in Table 2.19 and Table 2.20 [4, UBA, 2001], [21, Almeida, 2004].

Type of kiln	Process	Firing temperature (°C)	Firing time
Electric melting kiln with basket transportation	Melting decoration	760 – 840	2 – 4 h
Fast firing tunnel kiln (sledge or firing table)	On-glaze decoration	850 – 950	40 – 70 min
Roller hearth kiln with firing auxiliaries	On-glaze decoration	850 – 950	40 – 70 min
Roller hearth kiln with quartz goods	On-glaze decoration	1080	40 – 70 min
Double track belt conveyer kiln	On-glaze decoration	850 – 950	40 – 70 min
Double track belt conveyer kiln (special belt)	On-glaze decoration	1050	40 – 70 min
Tunnel kiln with plate transportation	Hard-firing decoration	1300 – 1400	7 – 16 h
Shuttle kiln	On-glaze decoration	850 - 950	8 – 10 h

Table 2.19: On-glaze decoration operating data

Type of kiln	Process	Firing temperature (°C)	Firing time
Shuttle kiln	Hard-firing decoration	1300 - 1400	14 – 24 h
Fast firing tunnel kiln (sledge or firing table)	Hard-firing decoration	1350 – 1420	2 - 4 h
Fast firing tunnel kiln (sledge or firing table)	In-glaze decoration	1200 – 1280	60 – 90 min
Roller hearth kiln with special rolls	In-glaze decoration	1200	60 - 90 min
Shuttle kiln	Under-glaze decoration	1370 – 1420	18 – 30 h
Tunnel kiln with kiln car	Under-glaze decoration	1370 - 1420	18 - 30 h
Tunnel kiln with firing table	Under-glaze decoration	1370 - 1420	12 – 16 h
Fast firing tunnel kiln (sledge or firing table)	Under-glaze decoration	1370 - 1420	3 – 4 h
Roller hearth kiln with special rolls	Under-glaze decoration	1350	2 - 4 h

Table 2.20: In-glaze and under-glaze decoration operating data

Another household ceramics manufacturing process, which is applied in a few cases, involves only one firing process without pre-firing. This one-time firing process suffices for undecorated products and for products with decorations applied prior to the glazing. The firing takes 20 hours in shuttle kilns, at a temperature of 1260 °C. Gold, platinum and other metallic colours have to be fired at the lower temperature of 890 °C [17, Burkart, 2004] [22, SYKE, 2004].

In the household ceramics manufacturing process, mainly natural gas and liquefied petroleum gas are used as fuels in the different types of kilns. Fuels such as fuel oil EL are rarely used in this sector.

2.3.6.6 Subsequent treatment

After decoration and quality control, the products are sorted. The wet subsequent treatment is carried out by grinding and polishing machines to smooth the surface of the products. Certain products are pre-packed mechanically. Then the sets for sale and dispatch are put together and manually packed. For the manufacture of modern tableware, semi-products are handled automatically by robots between the shaping, drying, firing and subsequent treatment stages.

2.3.6.7 Input and output flows in the manufacture of household ceramics

Important input and output flows of the household ceramics manufacturing process are presented in the following figure [4, UBA, 2001], [23, TWG Ceramics, 2005].

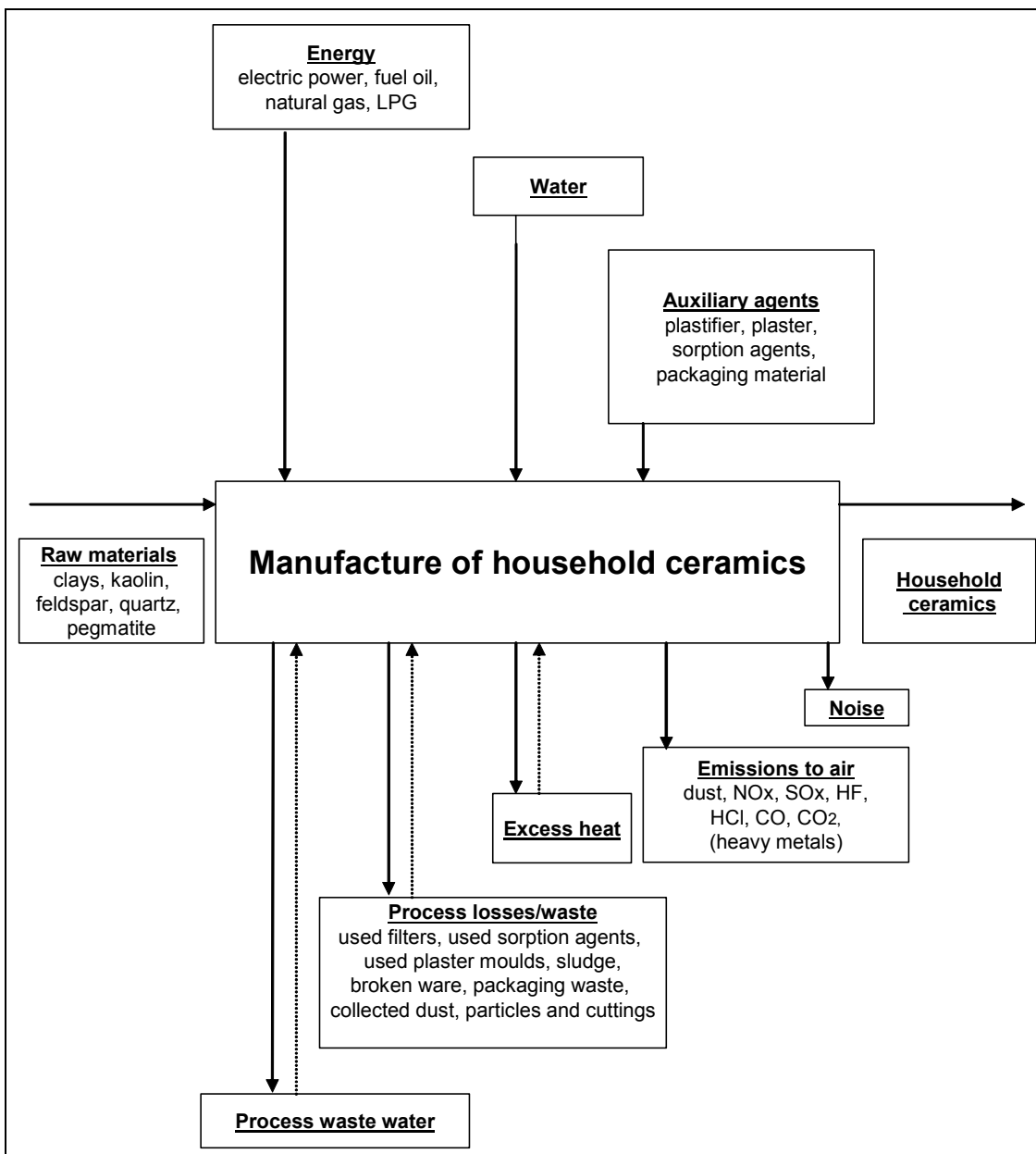

Figure 2.23: Input and output flows in the manufacture of household ceramics

2.3.7 Sanitaryware

The main process steps in the manufacture of sanitaryware are storage of raw materials, preparation of raw materials, shaping, drying and glazing, firing and subsequent treatment. The following figure shows a schematic view of the sanitaryware manufacturing process [4, UBA, 2001], [23, TWG Ceramics, 2005].

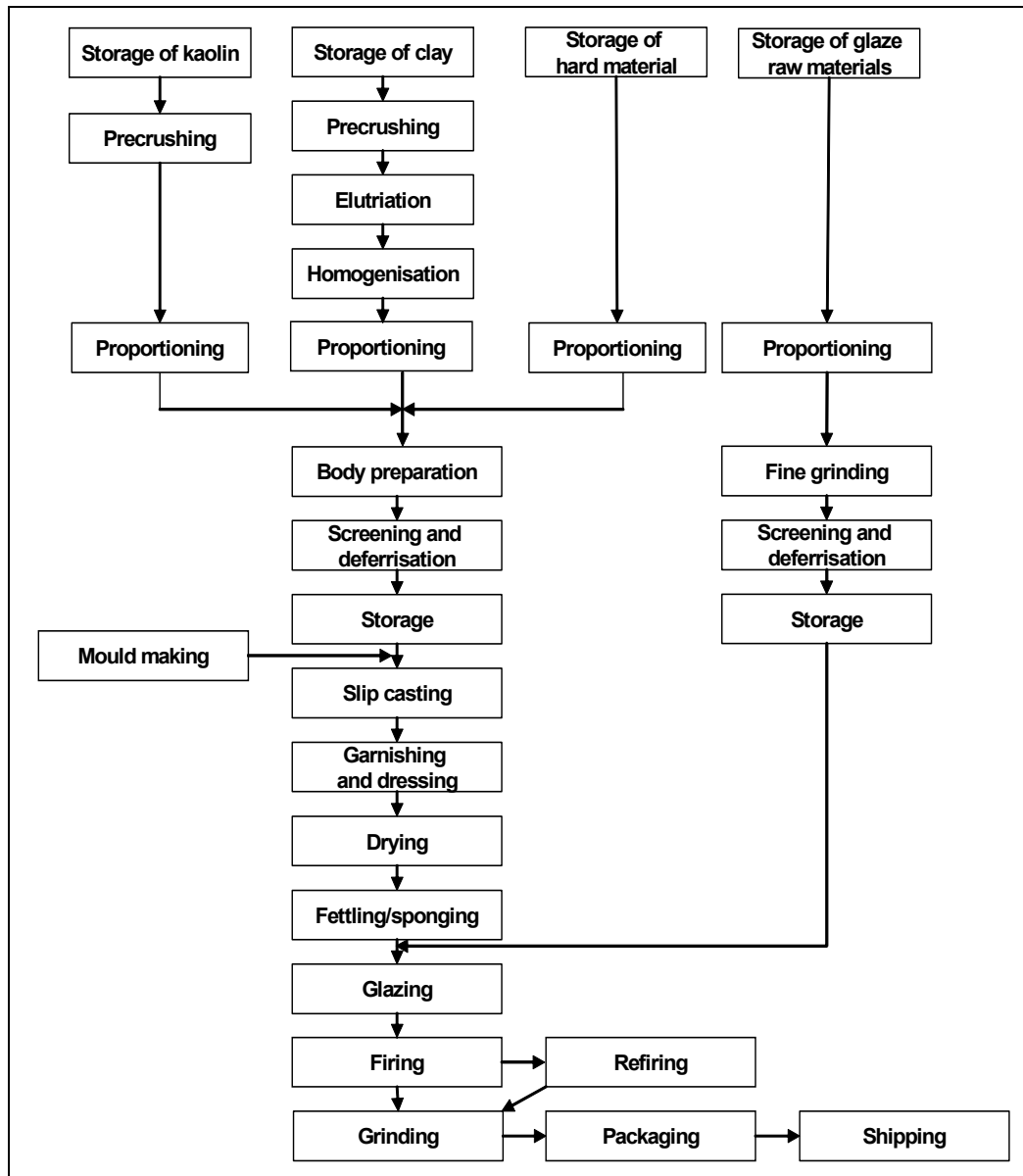

Figure 2.24: Schematic view of the manufacture of sanitaryware

2.3.7.1 Raw materials

The applicable raw materials are kaolin, clay, quartz, feldspar and calcium carbonate. A typical batch consists of 40–50 % kaolin and clay, 20–30 % quartz, 20–30 % feldspar and between 0–3 % calcium carbonate. Kaolin is stored preferably in lumps with a maximum water content of 15 per cent. Hard materials such as quartz and feldspar are ground to small particles and applied with a water content of less than one per cent. The raw materials are stored in silos or boxes to avoid any atmospheric influence.

2.3.7.2 Preparation of raw materials

The preparation of raw materials for sanitaryware is performed predominantly in a wet preparation process. Kaolin and clay are hackled in toothed roll crushers or similar units. After this step, the materials are reduced to a particle diameter of less than five millimetres in the fine grinding process. The material is elutriated in water and impurities are removed from the slurry by screening. Following this step, the screened clay suspension is homogenised in tanks by slow stirrers. The proportioning of hard materials is performed gravimetrically and electrolytes are added.

This preparation of the raw materials is not often performed by the ceramic manufacturer. The delivered raw materials are often only proportioned by the manufacturer, followed by the real production of slip in blungers [23, TWG Ceramics, 2005].

The subsequent storage in stirred tanks over a couple of days increases the shaping characteristics of the casting slip. Liquefactions and stability agents such as soda, water glass, caustic, potash and humic acid compounds are employed to achieve cast ability connected with a low water content. The glaze materials are proportioned and then mixed and ground in ball mills (batch) or in horizontal or annual gap mills (continuous). Binding agents such as carboxymethyl cellulose or polyamine are added to the glaze to maximise adhesion and gripping strength after the grinding. Deferrisation of body and glaze is carried out by permanent magnets to avoid colouring the products through magnetic impurities.

2.3.7.3 Shaping

Most ceramic goods are still shaped in plaster moulds today. The development trend is towards a plaster-free shaping process performed in porous polymer moulds. The casting process normally takes place in plaster moulds. Water leaves the casting slip through the porous areas of the plaster moulds to form the body. The body formation time is reduced by pressure. Complex sanitary goods are produced in the drain casting process. Additional solid casting parts are manufactured in a parallel process and are added and connected to the main body. In this garnishing process, the final shape of the product is created. After the separation of body and mould, the mould marks are fettled and further treated. The handling and dressing of the body is performed mostly automatically.

Bodies of sanitary ceramics are formed more and more by machines with multi-piece polymer moulds in combination with pressure casting. Depending on the article, four or five piece polymer moulds are used. Pressure of up to 3 MPa minimises the body formation time. The shaping cycle of lavatory bowls is reduced to five to eight minutes. Fettling and garnishing is usually performed while the body is fixed in the mould. The advantages of polymer moulds compared with plaster moulds are that they are easier to clean and have a longer lifetime.

2.3.7.4 Drying and glazing

The green ware is dried in two stages. After the leather-hard drying, the green ware is perfectly treated. The following white drying minimises the water content down to less than one per cent. The drying process takes place in tunnel or chamber dryers. Microwave dryers are built as tunnel dryers and are also used for leather-hard and white drying. The following table shows examples of operating data of periodically operated dryers [4, UBA, 2001], [21, Almeida, 2004].

Chamber dryers	Unit	Lavatory bowls and wash basins
Throughput	t/cycle	4 – 45
Drying chamber volume	m ³	30 – 375
Setting density	kg/m ³	30 – 200
Drying temperature	°C	60 – 90
Drying time	h	8 – 20
Specific energy requirement	kJ/kg	300 – 1400
Flue-gas volume flow	m ³ /h	2000 – 20000
Flue-gas temperature	°C	60 – 150

Table 2.21: Operating data of periodically operated dryers (chamber dryers)

After white drying, the green ware is inspected and the surface is cleaned of dust and foreign particles. The glaze is applied to the surface of the ware by spraying, performed by robots and hand spraying. The thickness of the glaze is between 0.3 and 0.5 mm, depending on the colour of the body and the opacifiers share of the glaze. Spraying in an electric field maximises the quality of the glaze.

2.3.7.5 Firing

Sanitaryware is fired in tunnel kilns and roller hearth kilns at temperatures of between 1250 and 1290 °C in an oxidising atmosphere. Small scale production is carried out in flexible periodically operated kilns such as shuttle kilns. Shuttle kilns are operated to change the product specific firing curve in very short cycles. Ranges of operating data of kilns for the manufacture of sanitaryware are presented in Table 2.22 and Table 2.23 [23, TWG Ceramics, 2005], [21, Almeida, 2004], [30, TWG Ceramics, 2005].

Tunnel kiln	Unit	Sanitaryware
Throughput	t/h	1.5 – 2.0
Kiln length	m	70 – 110
Cross-section	m ²	1.5 – 2.5
Setting density	kg/m ³	100 – 150
Firing temperature	°C	1250 – 1290
Specific energy requirement	kJ/kg	8300
Flue-gas volume flow	m ³ /h	12000
Flue-gas temperature	°C	150 – 550

Table 2.22: Operating data of tunnel kilns

Shuttle kiln	Unit	Sanitaryware
Throughput	t/cycle	5 – 15
Firing chamber volume	m ³	50 – 150
Setting density	kg/m ³	100
Firing temperature	°C	1210 – 1250
Specific energy requirement	kJ/kg	8300 – 11300
Flue-gas volume flow	m ³ /h	up to 50000
Flue-gas temperature	°C	150 – 550

Table 2.23: Operating data of shuttle kilns

In the sanitaryware manufacturing process, natural gas and liquefied petroleum gas are mainly used as fuels in the different types of kilns. Fuels such as fuel oil EL and heavy fuel oil are rarely used in this sector. Broken fired ware and refractory waste arise in the firing process. Broken fired ware consists of faulty goods after the firing process. Refractory waste results from broken parts of the kiln or from broken firing auxiliaries or tunnel car parts.

2.3.7.6 Subsequent treatment

After the final sorting, mounting surfaces are abraded by wet grinding and polishing. In special cases, fittings are added to lavatory bowls and cisterns followed by the final packaging.

2.3.7.7 Input and output flows in the manufacture of sanitaryware

Important input and output flows of the sanitaryware manufacturing process are presented in the following figure [4, UBA, 2001], [23, TWG Ceramics, 2005].

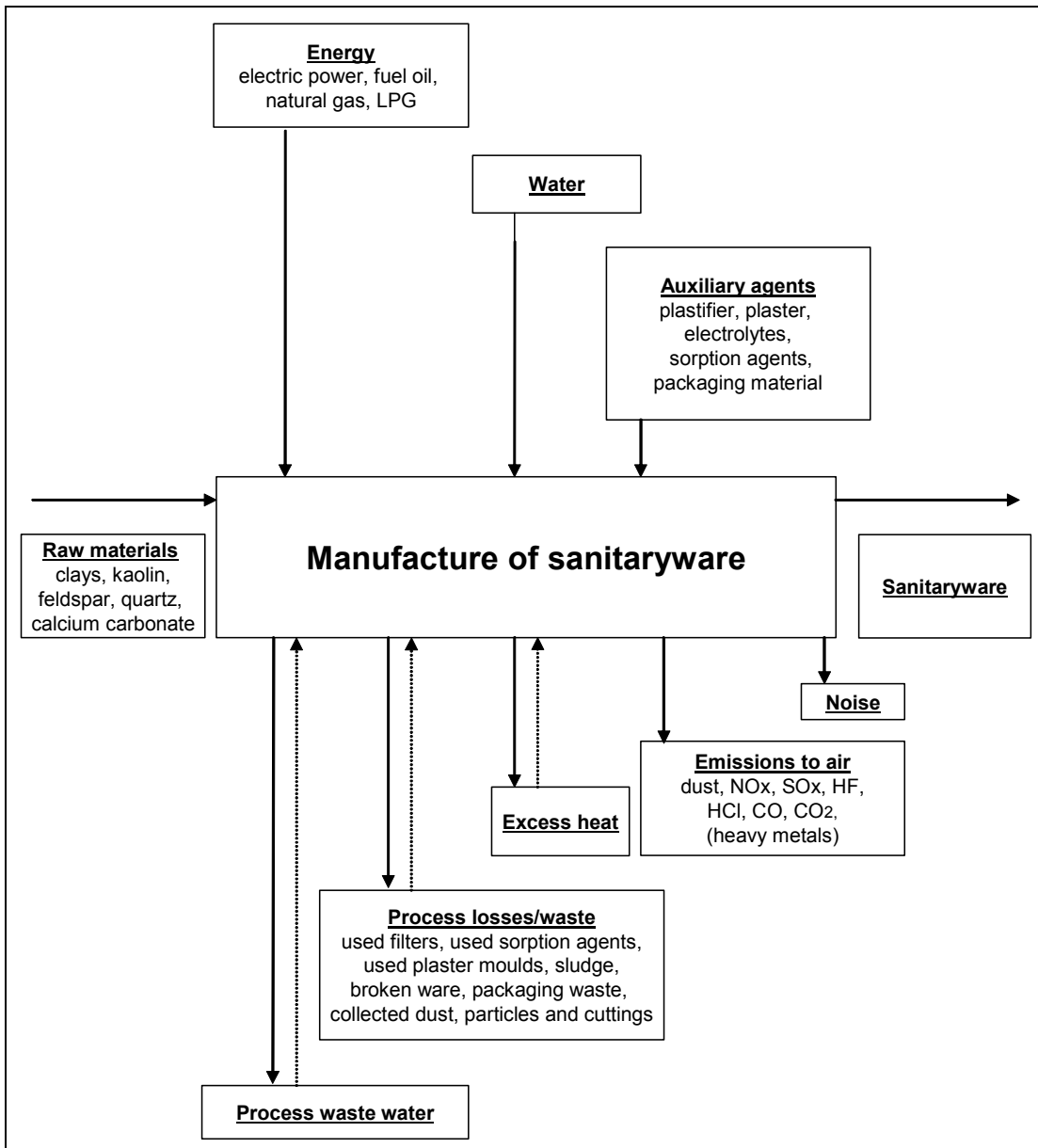

Figure 2.25: Input and output flows in the manufacture of sanitaryware

2.3.8 Technical ceramics

Technical ceramics are not only based on clays, but also on synthetic raw materials. Like the other ceramic sectors, the raw materials are fired in kilns, using mainly natural gas, but also electrical energy for the firing process.

Because of the wide variety of technical ceramics and manufacturing process variants involved, a general schematic view of the manufacturing process cannot easily be defined, but examples of schematic views of different manufacturing processes can be shown.

The following figure shows the schematic view of an electrical insulator manufacturing process [1, BMLFUW, 2003].

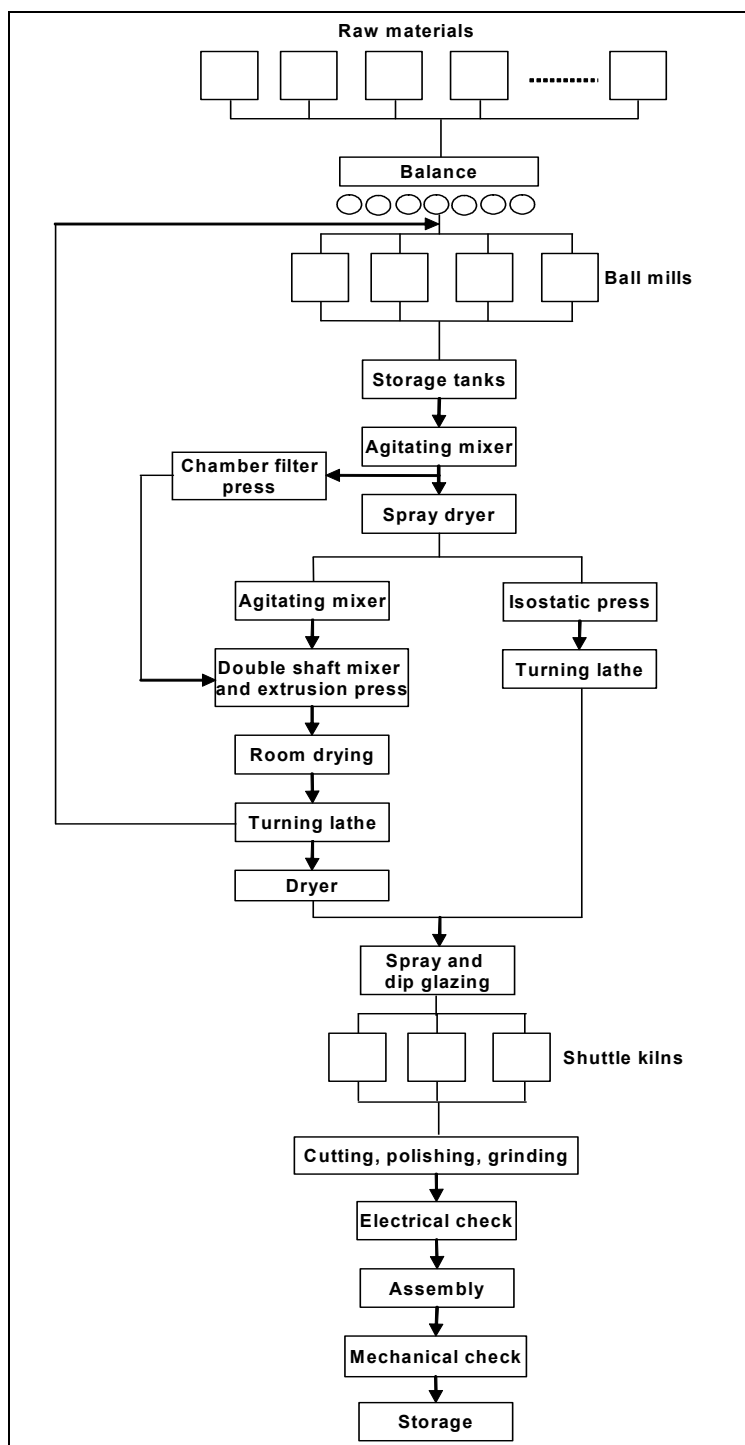

Figure 2.26: Schematic view of an electrical insulator manufacturing process

The following figure shows the schematic view of a ceramic catalyst manufacturing process [1, BMLFUW, 2003].

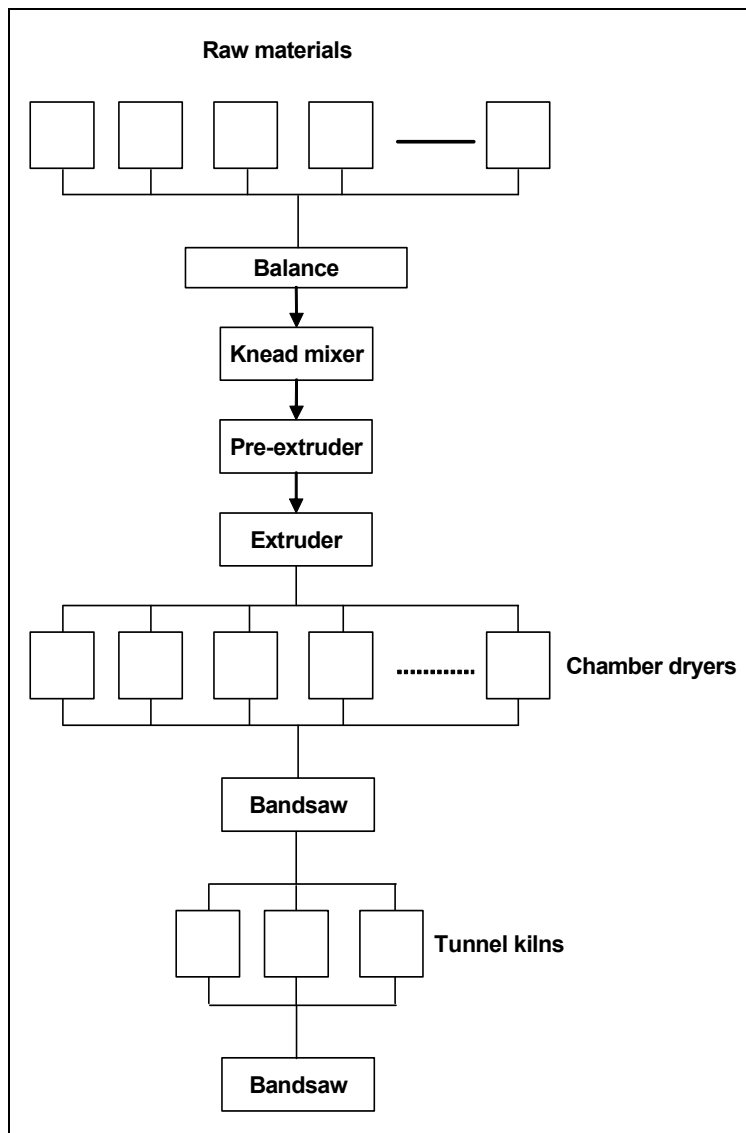

Figure 2.27: Schematic view of a ceramic catalyst manufacturing process

2.3.8.1 Raw materials

Technical ceramics, which contain only a small fraction of clay or none at all, are based on the following materials: oxides, carbides, nitrides and borides of Al, Mg, Mn, Ni, Si, Ti, W, Zr and other metal ions. Typical examples are Al_2O_3 (alumina), MgO (periclase or dead burned magnesia), SiC (silicon carbide), TiN (titanium nitride) and WB_2 (tungsten boride) [8, Ullmann's, 2001].

However, plastic clays (e.g. kaolin), feldspar and quartz can also serve as raw materials for technical ceramics, for example for the manufacture of electrical insulators [1, BMLFUW, 2003].

Additionally, additives (auxiliary agents) such as (inorganic) sintering aids and (usually organic) forming aids, such as liquefaction agents, plasticisers or binders are applied, which are as significant as the raw materials themselves [24, VKI-Germany, 2004].

2.3.8.2 Preparation of raw materials

There are two possibilities for the preparation of raw materials:

- a) The technical ceramics manufacturer acquires the necessary raw materials and carries out all further processing tasks. Specific preparations of unfired material are required for the different shaping processes:
 - granulates – for pressing
 - plastic material – for extrusion
 - slips – for casting.

- b) The technical ceramics manufacturer acquires ready-prepared unfired material, and begins at the proportioning or shaping stage of the ceramics process [24, VKI-Germany, 2004].

Technical ceramics often require chemical conversion of raw materials into intermediate compounds. These intermediates lend themselves to purification and eventual chemical conversion into a final form. For some technical ceramics, specialised powders have to be synthesised and a variety of chemical routes can be used to synthesise these powders. Chemical routes, such as sol-gel processing, can also bypass the powder stage.

Requirements for high strength and smooth finishes, particularly of small parts, necessitate fine grained powders. Thus, one line of technical ceramics research aims at producing very fine essential spherical, monosized particle powders. These are typically made by colloidal chemistry for oxides. The above-mentioned nitrides and carbides involve controlled nucleation and growth in gas-phase reactions. However, most high technology ceramics are still made from powders with a broad size distribution in the submicrometer range [8, Ullmann's, 2001].

Some raw materials are calcined ('dead-burned' at high temperatures), in order to make them suitable for the manufacture of technical ceramics. For more information on this, see Section 2.2.2.8.

Also the spray drying process is employed in the manufacture of technical ceramics. The aqueous suspension of raw material resulting from wet ball milling (solids content ~ 60 – 70 %) is sprayed under pressure to produce fine droplets which contact a stream of hot air. Drying of the droplets produces highly uniform, more or less spherical hollow granules (moisture content typically 5.5 – 7 %). This form of 'dust pressing powder' has high flowability, facilitating accurate filling of the press dies and the subsequent pressing of technical ceramic products [3, CERAME-UNIE, 2003].

It should be noted that especially synthetic materials, such as silicon carbide, calcined raw materials and also spray dried 'dust pressing powder' are often manufactured by specialist suppliers, but may still need to go through a comminution process.

However, not only 'dust pressing powder', but also 'extrusion paste' is produced, particularly if plastic clays serve as the raw materials for technical ceramics (e.g. for the manufacture of electroporcelain or ceramic catalysts) [1, BMLFUW, 2003]. To produce 'extrusion paste', the ground suspension is dewatered in filter presses or rotation filters to a water content of between approx. 20 and 25 %.

Another possibility for raw materials preparation is the production of casting slip in a wet preparation process. The delivered raw materials are often only proportioned by the manufacturer, followed by the step of slip production in blungers [23, TWG Ceramics, 2005].

2.3.8.3 Shaping

Methods of shaping technical ceramic parts can be divided into the following basic types [24, VKI-Germany, 2004]:

- pressing (0 – 15 % moisture; dry, isostatic, moist and wet pressing)
- plastic shaping (15 – 25 % moisture; extrusion)
- casting (>25 % moisture; injection moulding, slip casting, tape casting).

Dry pressing

Dry pressing is used to manufacture mass-produced precision products. Non-clumping granulates are compressed in steel dies designed appropriately for the part to be manufactured. The high cost for the dies (sometimes made of carbide) can only usually be justified for large runs.

Dry pressing is the most economic process for large production runs, and is suitable for both simple and complex geometries. Depressions and holes are normally only designed in the pressing direction. Depending on the design of the dry pressing machine, components ranging in size from tiles down to match-heads can be manufactured. Small discs or plates can be pressed with thicknesses of around 0.8 or 1.0 mm. It is still possible to manufacture fine ridges or similar structures on the component if the granulate being pressed can effectively fill hollows in the pressing tool, and provided it is possible to create the necessary tool.

Isostatic pressing

Isostatic pressing is suitable for the manufacture of uniformly compressed blanks and large parts, which are appropriate for machining in the green state. High quality products of the technical ceramics sectors require uniform densification of ‘dust pressing powder’, which can be achieved by applying pressure equally on all surfaces. In the isostatic press, rubber or polyurethane moulds are filled with ceramic powder and placed in a liquid filled vessel. A high hydrostatic pressure is then applied, followed by de-moulding the objects.

This type of forming is well suited to the manufacture of ambitious prototypes and small series, but for some products isostatic pressing can also be fully automated (spark plugs, grinding balls, small pistons, welding nozzles).

Wet pressing/moist pressing

Wet pressing/moist pressing allows the manufacture of parts with complex geometries such as screw threads, side holes, recesses and undercuts. The unfired material used for this purpose usually has moisture levels in the range of between 10 to 15 %. Compressing with a single axis makes these materials able to flow freely, so that relatively even compression can be achieved. The disadvantage of this, however, is that wet pressing materials can accept only low compressive strains. This also means that the degree of compression is limited. It depends heavily on the moisture content of the unfired material, and is lower than in the case of dry pressed parts.

Under some circumstances, moreover, it is necessary to dry the pressed parts before firing. Mean tolerances in accordance with DIN 40680-1 are based on this.

Extrusion

Extrusion is carried out using piston extruders or vacuum screw presses. In the plastic shaping process, for example for the manufacture of electrical insulators, the 'extrusion paste' (water content of between 20 and 25 % or between 19 and 23 % in high voltage insulator extrusion) is shaped in an extruder to the right geometry, cut into pieces and additional shaping with turning lathes is carried out [1, BMLFUW, 2003], [23, TWG Ceramics, 2005].

Extrusion is also suitable for manufacturing other rotationally symmetrical parts such as axles or pipes. Complex profiles can additionally be made with the aid of appropriate nozzle designs. The lengths of the billets to be manufactured depend to a large extent on the tendency of the processed material to warp.

Injection moulding

Injection moulding is principally suited to the mass production of complex products. It is limited by relatively high costs and the complex burnout of organic additives. The conveying capacity ('shot weight') of large injection moulding machines is typically up to about 70 g. Generally, the part should be designed so that thicknesses are as consistent as possible, having an upper limit of approx. 12 mm.

Slip casting

Slip casting is a simple method for the manufacture of prototypes, parts with complex geometries and relatively large items. It can be used to manufacture both thin-walled and solid objects. Ceramic slip casting involves a stable suspension, referred to as the slip, being poured into a porous, absorbent plaster mould. Extraction of the suspending liquid causes a layer of particles to develop on the mould wall. This layer develops, in solid casting, to create the fully moulded body. In the case of hollow casting, the superfluous slip is poured out once the desired wall thickness has been achieved.

Tape casting

Tape casting means that a ceramic slip containing various organic additives is poured onto an endless steel strip carried by rollers. The slip flows continuously from a reservoir through an adjustable slot onto the strip. Hot air is blown over the strip in the opposite direction to dry it, so that at the end of the strip, because of the organic additives, a flexible tape of green ceramic is obtained. This can either be wound up and stored for further processing at a later time, or maybe processed immediately through cutting, punching, stamping or other similar methods. Tape casting is typically used to manufacture ceramic parts with thicknesses ranging from 0.25 to 1.0 mm. The formed products are suited for the manufacture of substrates, housings, capacitors and multilayer transducers.

2.3.8.4 Machining

As shown in the following figure, green machining (after drying), white machining (after burning out and prefiring) and hard machining (after firing/sintering) can be distinguished [24, VKI-Germany, 2004].

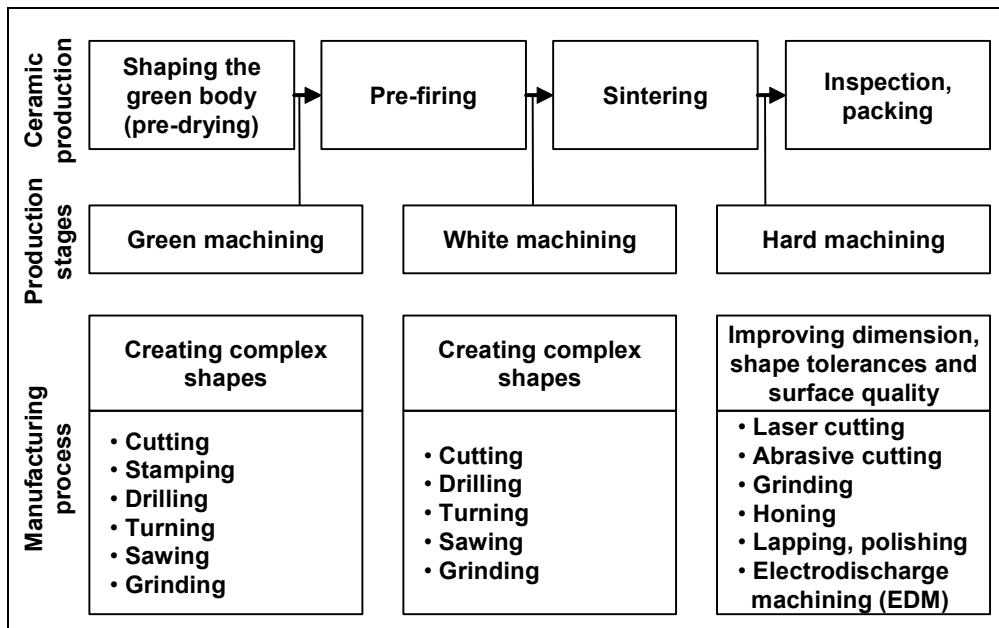

Figure 2.28: Green, white and hard machining in the manufacture of technical ceramics

Green machining is performed on the dry parts while they still contain organic additives. It is well suited to the manufacture of individual parts and small series. It is also used with large series to manufacture shapes that cannot be realised directly by initial shaping procedures, such as holes transverse to the direction of dry pressing.

White machining is performed on the prefired parts, now free from organic additives. The strength depends on the pre-firing. In this way, extremely high removal rates can be achieved with relatively low tool wear, using conventional, ceramic or diamond coated tools. This process is used by manufacturers both for making prototypes and for mass production.

Hard machining is carried out on fully fired/sintered items that have been brought as close as possible to the final dimensions through forming, or through green or white machining. The closest possible tolerances can be achieved through a final machining procedure involving material removal. Tight requirements for dimensional precision and the wide variety of geometries and surface qualities require the use of modern machine tools for processing ceramic components. Due to the high hardness of ceramic materials, diamond tools (bonded or pastes) are used here almost exclusively.

2.3.8.5 Glazing, engobing and metallisation

Glazing and engobing

By applying a glaze, surfaces are made smooth and visually more attractive, but above all, the glaze may noticeably improve many technically important properties of the ceramic product (for example, electrical behaviour, mechanical strength, resistance to chemicals, etc.). A wide variety of glaze colours can be created by mixing in colourants (metal oxides). In order to achieve a possible increase in strength, the thermal expansion coefficient of the glaze must be matched to that of the body very precisely. A slight compressive stress in the glaze increases the strength of the finished product, but tensile stress reduces this effect, and is thus undesirable.

In contrast to glazing, an engobe is porous and largely free from glass phase material. It usually consists of fire-resistant oxides (Al_2O_3 , SiO_2 , MgO , ZrO_2), mixtures of these, or of fire-resistant minerals such as mullite, spinel, zircon silicate, or even kaolin or clay. Engobes are used in furnace engineering to protect ceramic surfaces from mechanical or corrosive attack. Applied to fire-resistant kiln furniture such as plates, beams or cases, engobes prevent both contact reactions with the supported firing materials and adhesion from any glaze running off the fired items that are standing on the coated kiln furniture [24, VKI-Germany, 2004]

A thin mineral glaze or engobe layer is applied to ceramic surfaces by dipping, rolling, spraying or brushing.

Metallisation

Some manufacturers of technical ceramics offer metallised ceramics. Aluminium oxide and aluminium nitride are available as substrate materials. The metallisation offered is suitable for brazing and also for soft soldering and consists of a base metallisation of tungsten having a layer thickness of at least 6 μm , applied by a screen printing process. A layer of nickel, applied non-electrolytically, with a minimum thickness of 2 μm , is applied on top to assist the flow of solder. A gold layer with a thickness of approx. 1 μm can be deposited to protect against corrosion. Alternatively, the non-electrolytically applied nickel layer can be reinforced with a bondable gold layer. An additional layer of tin can also be applied if soft soldering is carried out [24, VKI-Germany, 2004].

2.3.8.6 Drying, burning out and pre-firing

Drying

Depending on the wide variety of raw materials and process variants, which are tailor made to reach the specific product properties, different types of dryers are used, but often chamber dryers are applied, especially if small scale production is undertaken.

Burning out

Green bodies shaped from plastic material are usually resistant to breakage in this state, but this resistance can still be improved with the aid of organic additives. Such additives are, however, indispensable when the unfired material is not plastic. Burning out the remaining plasticisers and binders along with other organic additives requires a carefully adapted temperature-pressure-atmosphere-time profile in order to achieve a non-destructive and reproducible removal of these additives from the finely porous green body. One variation of burning out is referred to as 'carbonising' or 'coking', for example with SiC. Here, organic components are converted to carbon, which remains in the structure and is converted, with the help of added reagents, to a ceramic matrix during the sintering reaction. After the drying and burning out (or carbonising/coking), the structure of the green body (pressed powder with the shape of component) is held together only by weak cohesive forces, and requires particularly careful handling during the subsequent process steps. For this reason, drying and burning out are integrated with the firing/sintering wherever possible [24, VKI-Germany, 2004].

Pre-firing

In order to reduce the level of risk during handling, and to allow the alternative white machining, the shaped green body can be strengthened by firing with relatively low shrinkage in preliminary firing. This requires strength and shrinkage to be made reproducible through control of the process parameters [24, VKI-Germany, 2004].

2.3.8.7 Firing/sintering

For firing, depending on the wide variety of raw materials and process variants, different types of kilns are used. Small scale production is carried out in flexible periodically operated kilns such as shuttle kilns, which are operated to change the product specific firing curve in very short cycles.

Typical sintering temperatures for technical ceramic materials are shown in the following table [24, VKI-Germany, 2004].

Technical ceramic material	Sintering temperature (°C)
Alumina porcelain	Approx. 1250
Quartz porcelain	Approx. 1300
Steatite	Approx. 1300
Cordierite	1250 – 1350
Aluminium oxide	1600 – 1800
Recrystallised silicon carbide	2300 – 2500
Sintered silicon carbide	Approx. 1900
Silicon nitride	Approx. 1700

Table 2.24: Sintering temperatures for technical ceramic materials

The energy required for the firing process increases disproportionately as the firing temperature rises. In addition to the energy input, the firing auxiliaries ('kiln furniture') used to stack the green bodies in the kiln is made of refractory material which can withstand very high temperatures. Special varieties of material can be created from some ceramic materials with the aid of particular types of firing processes [24, VKI-Germany, 2004]:

Hot pressing (HP)

Hot pressing is used to manufacture components with a density close to the theoretical maximum. It is a sintering process supported by uniaxial pressing.

Hot isostatic pressing (HIP)

Hot isostatic pressing allows small parts particularly to achieve the maximum density through the application of isostatic gas pressure of up to 3000 bar at temperatures of up to approximately 2000 °C (usually within a collapsible silicate glass envelope).

One example for firing technical ceramics in large shuttle kilns is the manufacture of electrical insulators by employing a modulated temperature programme (kiln capacity 100 m³ with a setting density of 260 kg/m³, firing temperature of up to 1300 °C, firing time including a cooling phase of 80 – 105 hours) and using natural gas as the fuel [1, BMLFUW, 2003].

Another example for the use of shuttle kilns is the manufacture of firing auxiliaries ('kiln furniture') [17, Burkart, 2004]:

- H-cassettes, which are shaped from special refractory clays, are fired in shuttle kilns (setting density below 300 kg/m³, kiln volume 12 m³) at a temperature of 1360 - 1390 °C with natural gas as the energy source. They are used as firing auxiliaries in roof tile manufacturing processes
- SiC firing auxiliaries, which are shaped from SiC powder and organic binders, are fired in electrical induction shuttle kilns (setting density below 300 kg/m³) at a temperature of 2000 – 2500 °C under a hydrogen/nitrogen atmosphere. They are used in other manufacturing processes, in particular porcelain glost fast firing.

However, tunnel kilns are also employed for the manufacture of technical ceramics. An example is the firing of ceramic catalysts in a 63 m long tunnel kiln at a maximum temperature of 650 °C and with a throughput of 0.76 m³/h [1, BMLFUW, 2003].

2.3.8.8 Subsequent treatment

Depending on the wide variety of technical ceramics, often subsequent treatment like cutting, sawing, grinding, polishing and assembling with other parts may be necessary. In this context, see Section 2.3.8.4, especially regarding hard machining. After final quality control, the products are sorted and packed.

2.3.8.9 Input and output flows in the manufacture of technical ceramics

Important input and output flows of technical ceramics manufacturing processes are presented in the following figure [23, TWG Ceramics, 2005], [24, VKI-Germany, 2004].

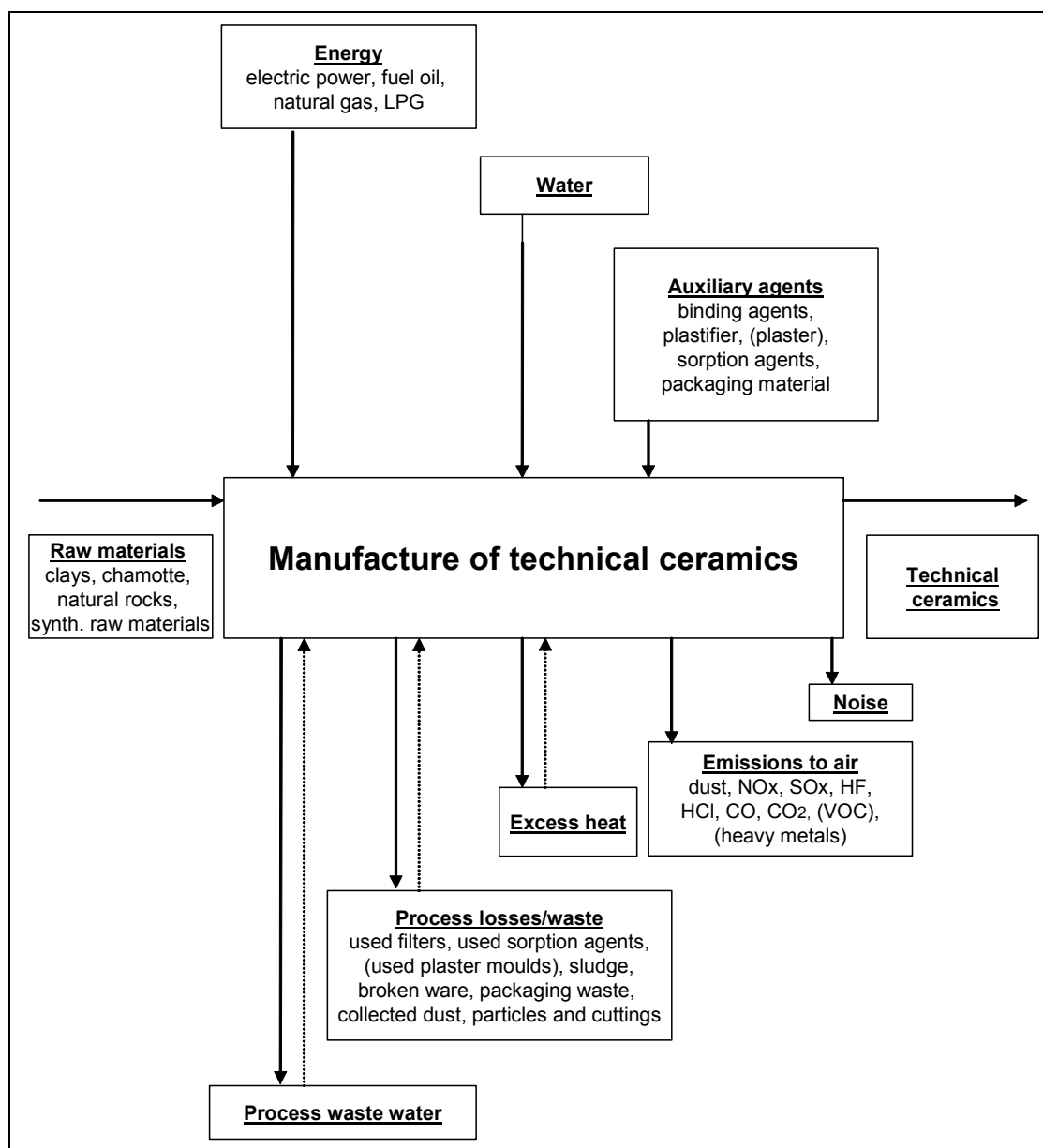

Figure 2.29: Input and output flows in the manufacture of technical ceramics

2.3.9 Inorganic bonded abrasives

2.3.9.1 Raw materials

Inorganic bonded ceramic abrasives consist of abrasive grains, binding agents and several additives, which are mixed, shaped, dried and fired [14, UBA, 2004].

The most used abrasive grains for the manufacture of inorganic bonded abrasives are special fused alumina, corundum, black and green silicon carbide. Cubic boron nitride (CBN) and diamond are also used.

The binding agent is typically made of the following components:

- feldspar
- silicates
- quartz
- frits (glass with a defined composition)
- kaolin (china clay)
- clay
- nepheline
- pigments.

The composition varies depending on the application profile of the abrasives. Consequently also pure frit binders or special binders with a defined thermal coefficient of expansion and/or melting point might be applied. In some cases, frits might contain high shares of alkali and boron. Colouring metal oxides, colouring glass or colouring pigments might be added to obtain a specific colour.

Auxiliary substances are used during the manufacturing process of inorganic bonded abrasives to realise required characteristics and shapes. However, these auxiliary substances are not ingredients of the final product.

Temporary binding agents are necessary for the manufacture of inorganic abrasives to keep the mixture of grain and binder in the right shape before the firing process. For temporary binders, water soluble glues, wax emulsions, converted starch like dextrin, polyoxyethylene preparations, lignosulphonates, converted urea-formaldehyde condensation products, synthetic resins, etc. are alternatively used.

Pore-forming agents have the function of generating a defined pore profile in the abrasives. Pore-forming agents are added to the raw material and evaporate, sublimate, depolymerise, or incinerate, depending on the substance used, during the drying or firing process. Depending on the final product, different pore forming agents are used. Naphthalene or other thermal calcinating substances are applied.

2.3.9.2 Preparation of raw materials

The first step of the manufacturing process of inorganic bonded abrasives is the weighing and the mixing (e.g. in a horizontal bed mixer) of the components according to the abrasive formulation.

2.3.9.3 Shaping

For the manufacture of inorganic bonded abrasives, the raw workpieces are mechanically compressed to a specific density according to the default form and weight requirements. For this purpose, hydraulic or eccentric presses with pressure ranges of up to 2500 MPa are used [14, UBA, 2004].

2.3.9.4 Drying

As the compressed material is moisturised with water containing glue, the raw workpiece has to be dried. Chamber dryers and vacuum dryers are applied, in which the products are dried at temperatures of between 50 and 150 °C. Long drying times of up to 45 hours are necessary for a crack free drying and the dryers can also be air conditioned (in particular, vacuum dryers are equipped with a humidity control) for a crack free drying [14, UBA, 2004] [28, Schorcht, 2005].

2.3.9.5 Firing

The firing of inorganic bonded abrasives takes place in natural gas or electrically heated periodically or continuously operated kilns. Example plants operate kilns with capacities of more than 4 m³ (up to 11 m³), firing temperatures of between 850 to 1300 °C and setting densities of between 360 to 1400 kg/m³ [14, UBA, 2004]. The share of the vitrified bond in the ware to be fired comes to about 10 % of the total mass of inorganic bonded abrasives in the kiln. Depending on the size of the abrasive wheel products, the firing cycles take between 40 to 120 hours [28, Schorcht, 2005], [30, TWG Ceramics, 2005].

2.3.9.6 Subsequent treatment

After the determination of the quality (grade, density) of the abrasive, the finishing of the abrasives is carried out related to customer specific requirements, for instance with computer aided lathes or grinding machines. Afterwards, the final inspection which normally covers an out-of-balance check, dimensional, ring test and visual inspection, a safety speed and a bursting speed test take place conforming to standards. After the final inspection, the inorganic bonded abrasives are labelled conforming to standards and packed for consignment [14, UBA, 2004], [30, TWG Ceramics, 2005].

2.3.9.7 Input and output flows in the manufacture of inorganic bonded abrasives

Important input and output flows of inorganic bonded abrasives manufacturing processes are presented in the following figure [14, UBA, 2004], [23, TWG Ceramics, 2005].

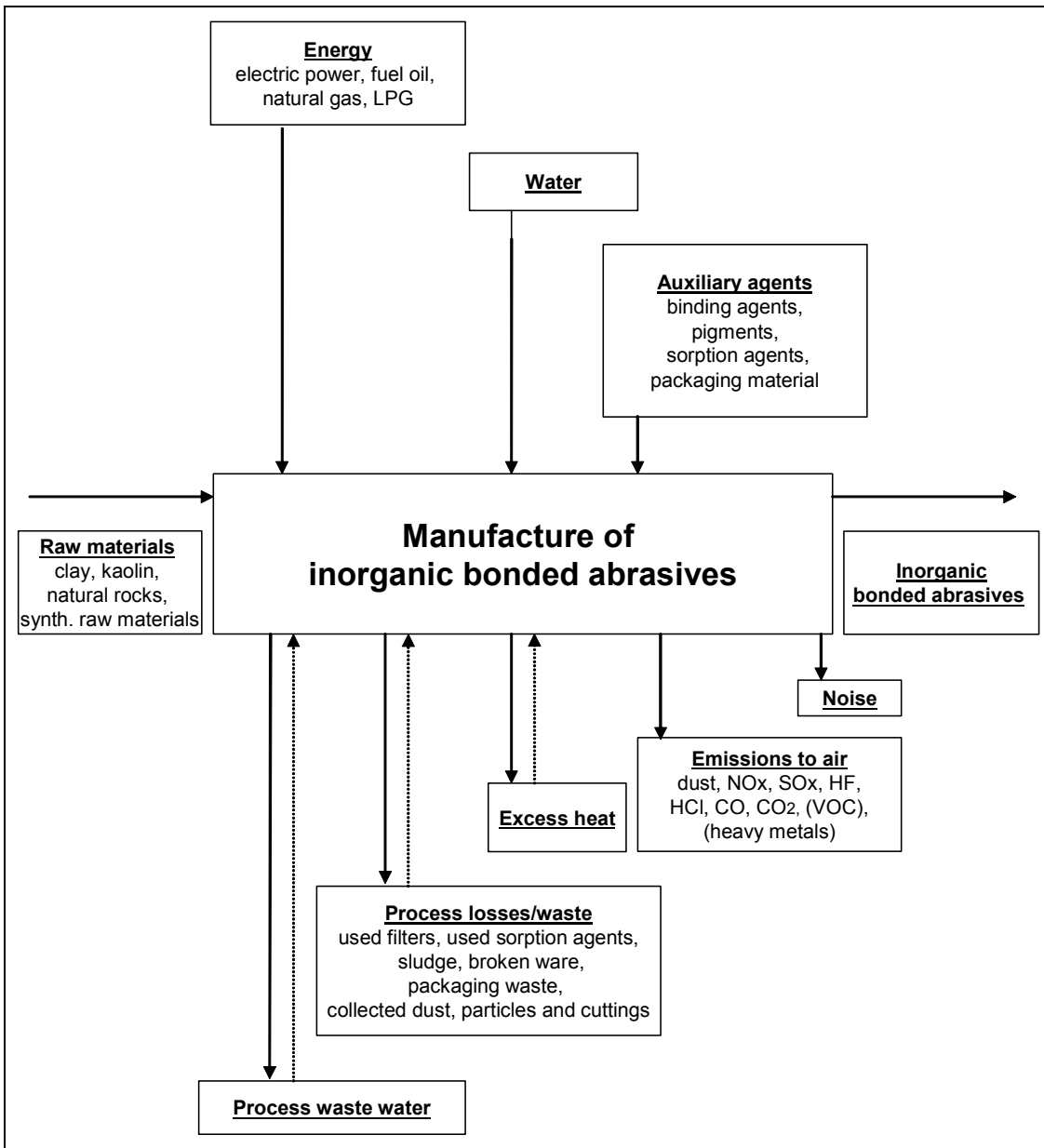

Figure 2.30: Input and output flows in the manufacture of inorganic bonded abrasives

3 CURRENT EMISSION AND CONSUMPTION LEVELS

3.1 Emissions – general considerations

3.1.1 Emissions to air

3.1.1.1 Dust (particulate matter)

The processing of clays and other ceramic raw materials inevitably leads to dust formation – especially in the case of dry materials. Drying, (including spray drying), comminution (grinding, milling) screening, mixing, conveying can all result in a release of fine dust, necessitating dust extraction equipment. Some dust also forms during decorating and firing of the ware, and during machining or finishing operations on fired ware. Dust is one of the main pollutants, in quantitative terms, from the ceramic processes.

3.1.1.2 Gaseous emissions

The gaseous compounds released during drying, calcining and firing are derived from the raw materials as well as fuels contribute gaseous pollutants. Fluorine compounds represent one of the main typical pollutants from ceramic processes. Gaseous emissions relevant to the ceramic industry are as described from Section 3.1.1.2.1 to 3.1.1.2.7:

3.1.1.2.1 Sulphur dioxide and other sulphur compounds

The concentration of SO_x (mainly SO_2) in flue-gases is closely related to the sulphur content of the raw material, and of the fuel. Ceramic materials may contain sulphur in the form of pyrite (FeS_2), gypsum and other sulphates, and organic sulphur compounds. Gaseous fuels are virtually sulphur-free, but solid fuels and fuel oils contribute sulphur oxides on combustion.

It should be noted that basic compounds from raw materials (e.g. CaO formed by dissociation of CaCO_3 during firing) can reduce sulphur emissions by reacting with sulphur oxides. The reaction products are retained within the body of the ware.

3.1.1.2.2 Oxides of nitrogen and other nitrogen compounds

NO_x is mainly produced by thermal ‘fixation’ of nitrogen and oxygen from the combustion air. This reaction is favoured by high temperatures (especially $>1200\text{ }^\circ\text{C}$) and by excess oxygen. Fixation can occur within hot flames, even when the actual kiln temperature is below $1200\text{ }^\circ\text{C}$.

Nitrogen compounds present in fuels (mainly solid or liquid types), or in organic additives, form NO_x during combustion at much lower temperatures.

3.1.1.2.3 Carbon monoxide (and carbon dioxide)

Carbon monoxide, CO, arises from the combustion of organic matter in the ceramic body – especially under low oxygen conditions. It may also be formed by the reaction of ‘fixed carbon’ in the body with carbon dioxide (CO₂) released by the thermal dissociation of alkali and earth alkali carbonates, for instance calcium or magnesium carbonate during firing:

- $\text{CaCO}_3 \rightarrow \text{CaO} + \text{CO}_2$
- $\text{C} + \text{CO}_2 \rightarrow 2\text{CO}$

(Carbon dioxide forms as above, and is the main oxide of carbon formed during the combustion of fossil fuels).

3.1.1.2.4 Volatile organic compounds (VOCs)

Ceramic raw materials may themselves contain organic matter, and a wide range of organic materials are added in the form of binding agents, pore-forming agents, drying aids, adhesives, body fuels, burnout additives, etc.

During the early heating process, carbonisation of organic compounds may occur with the release of a complex range of VOCs.

3.1.1.2.5 Metals and their compounds

The heavy metal content of most ceramic raw materials is very low, and causes no emission problems. Exceptions occur in the case of ceramic pigments and glaze materials, but present practice is to use coloured compounds (‘stain’ containing pigments), which are stable at high temperatures and inert in silicate systems, where the metallic oxides have a stable crystal structure like spinel or zircon [23, TWG Ceramics, 2005]. These types of glaze are also subject to extremely short firing cycles, minimising the risk of volatility.

Heavy fuel oils and solid fuels may contain low levels of nickel and vanadium, but tests have shown these elements to be largely absorbed by a reaction with the product during firing.

3.1.1.2.6 Chlorine and its compounds

Most clays contain trace levels of chloride, often derived from an original marine formation, but also additives or water containing chloride are possible sources of hydrochloric acid (HCl) emissions (e.g. the Cl content of water added during the preparation of the raw materials may be in the range of 50 – 100 mg/l or even higher) [23, TWG Ceramics, 2005], [30, TWG Ceramics, 2005]. Due to the decomposition of mineral salts containing chloride at temperatures in excess of 850 °C and of organic compounds containing chloride at temperatures of between 450 and 550 °C, HCl occurs during the firing process in the flue-gases of a kiln [25, Voland, 2004].

3.1.1.2.7 Fluorine and its compounds

Nearly all natural raw materials contain fractional amounts of fluoride (which readily substitutes for OH groups in clays and hydrous minerals). Hydrofluoric acid (HF) comes mainly from the decomposition of these fluorosilicates present in clay material. The emission of HF takes place in accordance with two different mechanisms:

- by direct decomposition of the fluoride minerals which depends heavily on the type of clay (e.g. smectite at temperatures from 550 °C, illite at temperatures from 750 °C, apatite at temperatures from 600 to 700 °C)
- by decomposition of CaF₂ at temperatures in excess of 900 °C, the reaction is favoured by the presence of water vapour [23, TWG Ceramics, 2005], [25, Voland, 2004].

In this context, the water, present in the kiln atmosphere (e.g. formed by combustion of fuels), plays an important role in the mechanism of HF formation. The following reactions are involved:

- mineral-F + H₂O → mineral-OH + HF (1) (release of HF by hydrolysis of mineral-F)
- 2HF + CaO → CaF₂ + H₂O (2) (resorption of HF)
- CaF₂ + H₂O → 2HF + CaO (3).

Reaction (2) occurs at relatively low temperatures, in the preheating section of the kiln. It explains why the presence of CaCO₃/CaO (limestone/lime) can result in a significant reduction of HF emissions. Slow preheating increases the reaction time for resorption and may result in lower HF emissions. Reaction (3) occurs at higher temperatures (>900 °C) if the water concentration in the kiln is very high [2, VITO, 2003], [23, TWG Ceramics, 2005].

The concentration of fluoride in flue-gases is not only related to the level in the raw materials, the presence of water vapour, the body composition and the temperature curve, but also the setting and the specific surface of the ware to be fired effect the diffusion of H₂O and HF into and out of the ware (see Sections 4.3.3.1 and 4.3.3.2) [23, TWG Ceramics, 2005], [30, TWG Ceramics, 2005].

3.1.2 Emissions to water

Water is a very important raw material in the ceramic manufacturing industries, but the amount used varies greatly between sectors and processes. The water added directly to ceramic body mixes does not lead to a waste water problem, as it is subsequently evaporated into the air during the drying and firing stages. Process waste water is generated mainly when clay materials are flushed out and suspended in flowing water during the manufacturing process and equipment cleaning, but emissions to water also occur during the operation of wet off-gas scrubbers.

Process waste water occurs in small quantities in the manufacture of bricks and roof tiles, vitrified clay pipes and refractory products, if surface treatment such as glazing and engobing, or wet grinding is carried out. Additional amounts of water arise in the cleaning process of the mixing, engobing and glazing units, and of the moulds. In expanded clay aggregates production, usually no process waste water is generated, only the cooling water for the kiln system passes through an oil separator and is returned to the cooling circuit.

In the wall and floor tiles, table- and ornamentalware, sanitaryware, technical ceramics and inorganic bonded abrasives sectors, process waste water occurs mainly as cleaning water in preparation units, in casting units, in the glazing and decoration process or as grinding water in subsequent treatment.

Effluents which arise as a result of compound processing and equipment cleaning usually contain the same raw materials and auxiliary materials as those used in the process concerned. As a rule, these compounds are water insoluble.

The waste water in the process mostly shows turbidity and colouring owing to the very fine suspended particles of glaze and clay minerals. From a chemical point of view, these are characterised by the presence of:

- suspended solids: clays, frits and insoluble silicates in general
- dissolved anions: sulphates
- suspended and dissolved heavy metals: e.g. lead and zinc
- boron in small quantities
- traces of organic matter (screen printing vehicles and glues used in glazing operations).

3.1.3 Process losses/waste

Process losses/waste originating from the manufacture of ceramic products, mainly consist of the following materials:

- different kinds of sludge originate from the process waste water treatment facilities of water arising in the processes involved in cleaning body preparation, glaze preparation and application equipment, and also from wet grinding. The quantity and composition of sludge varies considerably as, besides arising in the different production processes, a great variety of raw materials tends to be used (different glazes, frits, clays, etc.), even in the same facility, which produce significant fluctuations in sludge composition
- broken material/ware arises from shaping, drying, firing, subsequent treatment and broken refractory material
- dust arises from off-gas cleaning units
- used plaster moulds arise from shaping processes
- used sorption agents (granular limestone, limestone dust) arise from flue-gas cleaning systems
- packaging waste (plastic, wood, metal, paper, etc.) arises in the packaging step
- solid residues, e.g. ashes arise from firing with solid fuels.

Parts of the accumulated process losses mentioned above, can be recycled and re-used within the plant due to product specifications or process requirements. Materials, which cannot be recycled internally, leave the plant to be used in other industries or to be supplied to external waste recycling or waste disposal facilities.

3.1.4 Emissions of noise

Noise occurs in the several steps during the manufacturing processes of ceramic products, mainly by operating noise generating machinery and by carrying out noisy working procedures.

3.1.5 Possible emission sources and emission paths

The following table provides an overview on possible emission sources of important process steps in ceramic manufacturing and the corresponding emission paths [23, TWG Ceramics, 2005], [26, UBA, 2005], [27, VDI, 2004], [30, TWG Ceramics, 2005].

Process step	Emission from				Emission into			Emission of noise
	Raw material	Ceramic bodies	Deco-ration	Fuel	Air	Water	Land (process losses/waste)	
Raw material preparation								
Primary/secondary crushing and grinding	x				x		x	x
Dry milling and dry mixing	x			x ¹⁾	x		x	x
Wet milling and wet mixing	x					x	x	x
Screening/classification	x				x		x	x
Conveying	x				x		x	
Storage in silos	x				x			x
Body preparation								
Casting slip		x				x		
Extrusion paste for soft-plastic shaping		x			x	x	x	
Bodies for hard-plastic shaping by chip removing processes		x				x	x	
Dust pressing powder, dry process		x			x	x	x	x
Dust pressing powder, spray drying process		x		x	x	x	x	x
Granulation		x			x			x
Shaping								
Slip casting		x				x		
Soft-plastic shaping ('extrusion')		x				x	x	
Shaping by cutting		x					x	
Pressing		x			x	x ²⁾	x	x
Treatment of green bodies		x			x	x	x	
Drying								
Intermittent and continuous dryers		x		x	x			x
Decorating								
Glazing			x		x	x	x	
Engobing			x		x ³⁾	x	x	
Printing			x		x	x	x	
Firing								
Intermittent and continuous kilns	x	x	x	x	x			x
Subsequent treatment								
Material storage	x	x		x	x ⁴⁾			x

¹⁾ Possible for special applications, e.g. hot dry grinding of expanded clay aggregates
²⁾ Only cooling water
³⁾ For some sectors, e.g. ceramic tiles
⁴⁾ Material storage also covers storage of fuels

Table 3.1: Overview on possible emission sources and emission paths in the ceramic industry

3.2 Consumption – general considerations

3.2.1 Energy consumption

The primary energy use in ceramic manufacturing is for kiln firing and, in many processes, drying of intermediates or shaped ware is also energy intensive. Natural gas, LPG and fuel oil are employed for most drying and firing operations, but solid fuels, electricity, LNG and biogas/biomass are also used.

Plant and machinery used for the comminution and mixing of raw materials, and the forming of ware, require electrical energy. Diesel fuel is required for on-site transportation, which may include haulage of raw materials from a quarry, and internal transport with lorries. Additionally, electricity (battery powered) and LPG bottles (butane, propane) are also used for on-site transportation, for instance with forklifts.

The brick and roof tile and the wall and floor tile sectors are the biggest energy consumers, but this is related to their larger tonnage outputs. In terms of specific energy consumption, the brick and roof tile sector shows the highest efficiency [3, CERAME-UNIE, 2003].

It should be noted that electrical heating of kilns is nevertheless employed for certain tableware and technical ceramics [14, UBA, 2004], [17, Burkart, 2004]. This is necessary to achieve the required quality.

3.2.2 Water consumption

Water is used in virtually all ceramic processes, and good quality water is essential for the preparation of clays and glaze slips; clay bodies for extrusion and ‘muds’ for moulding; preparation of spray dried powders; wet grinding/milling; washing operations.

Water is used for different purposes: basically, as a raw material for the body and its preparation, as a raw material for glazes, as a washing fluid and as a cooling medium. Good quality water is required for glazes, washing and cooling purposes. Low quality water – like untreated process waste water from washing operations in the glaze section – can be suitable for the body. Process waste water re-use techniques take these different qualities into account.

3.2.3 Raw materials consumption

A vast range of raw materials is consumed by the ceramic industry, as indicated in Chapter 2. These include the main body forming materials, involving high tonnages, and various additives, binders and decorative surface-applied materials which are used on a lesser scale.

3.3 Presentation of emission and consumption data

This section reports on the ranges of currently observed emission and consumption levels for the manufacturing processes. Information includes currently observed usage of energy, water and raw materials and, as far as available, data include emissions to air and water arising from the activities as well as inputs to and outputs from sub-processes including compositions of sludge and solid process losses. Noise emission data are not included, because many noise aspects are not really sector specific and no suitable noise emission data for ceramic manufacturing processes are available.

Performance data will be qualified as far as possible with details on operating conditions, sampling and analytical methods, and statistical presentations (e.g. averages, maxima, minima and ranges).

Regarding the standard conditions for measurements of volume flows and concentrations, see the following definitions, which are also stated in the Glossary:

m ³ /h	volume flow: if not otherwise mentioned in this document, the volume flows refer to 18 vol-% oxygen and standard state.
mg/m ³	concentration: if not otherwise mentioned in this document, the concentrations of gaseous substances or mixtures of substances refer to dry flue-gas at 18 vol-% oxygen and standard state, and benzene concentrations refer to 15 vol-% oxygen and standard state.
standard state	refers to a temperature of 273 K and a pressure of 1013 hPa.

Additional useful information can be found in the Reference Document on the General Principles of Monitoring (MON).

In view of the complexity of the ceramic industry, the data in the form of examples and ranges of currently observed emission and consumption levels are summarised on a sectoral basis in tables and figures placed within this section.

3.3.1 Bricks and roof tiles

3.3.1.1 Emission data

Emissions to air and water, process losses/waste and also noise emissions arise in the manufacture of bricks and roof tiles. In this section, ranges of air pollutant emissions are presented for the firing of bricks and roof tiles. Emissions to air from other process steps, emissions to water and process losses are also described.

Emissions to air

Significant emissions to air in the manufacture of bricks and roof tiles arise in the firing process. In this context, it has to be mentioned that the emissions vary to a great extent from country to country and within countries from site to site depending on the different clay raw materials being used – because of the geological and geographical variations – as described in Section 2.3.1.1 (see in particular Table 2.1) and also on the differences in the manufacturing techniques applied to match the diversity of the product range.

In this context, the data listed in the following table, demonstrate the ranges of emissions occurring in some European countries for fluorides, chlorides, oxides of sulphur, oxides of nitrogen, dust and carbon monoxide. All the data given in this table are emissions in the uncleaned flue-gases from the kilns, i.e. without taking into account any abatement equipment [20, CERAME-UNIE, 2004], [23, TWG Ceramics, 2005], [21, Almeida, 2004].

Emission component (mg/m ³)	Austria	France	The Netherlands	Italy	Denmark ^{*)}	
Fluoride as HF						
Minimum	0	1	1	0	10	
Maximum	60	130	150	350	150	
Chloride as HCl						
Minimum		0	1	0	5	
Maximum		30	32	200	50	
Sulphur as SO_x						
Minimum	5	0	2	0	20	
Maximum	100	1090	630	3200	700	
Nitrogen as NO_x						
Minimum	9	5	27	5	50	
Maximum	80	200	464	100	200	
Dust						
Minimum	0	1	1	1	5	
Maximum	13	180	64	40	40	
Carbon monoxide						
Minimum		0	7	100		
Maximum		1200	701	500		
*) Oxygen concentration reference of 15 – 19 vol-% corresponding to measured oxygen content of the flue-gas						
Emission component (mg/m ³)	Belgium	United Kingdom	Germany	Hungary	Switzerland	Portugal
Fluoride as HF						
Minimum	6	1	1	0	0	1
Maximum	117	200	250	20	22	80
Chloride as HCl						
Minimum	0	1	0			Not detected
Maximum	270	125	95	50		160
Sulphur as SO_x						
Minimum	3	8	1	1	1	3
Maximum	3485	2450	3000	350	281	443
Nitrogen as NO_x						
Minimum	0	0	10	0	36	14
Maximum	174	160	450	780	147	132
Dust						
Minimum	2	0	5	1	1	8
Maximum	449	100	150	100	29	125
Carbon monoxide						
Minimum	23		0	1	7	2
Maximum	1950		1500	1500	483	500

Table 3.2: Emission ranges of raw flue-gases from the firing process of brick and roof tiles manufacturing

The fluoride emissions vary considerably, as shown in Table 3.2, not only because of the variation in fluoride content of the raw materials, but also because of differences in the manufacturing techniques being used. As an example, the following figure shows the distribution of released fluoride with respect to the final product, based on Italian research and referring to Figure 2.9 [20, CERAME-UNIE, 2004], [23, TWG Ceramics, 2005], [30, TWG Ceramics, 2005].

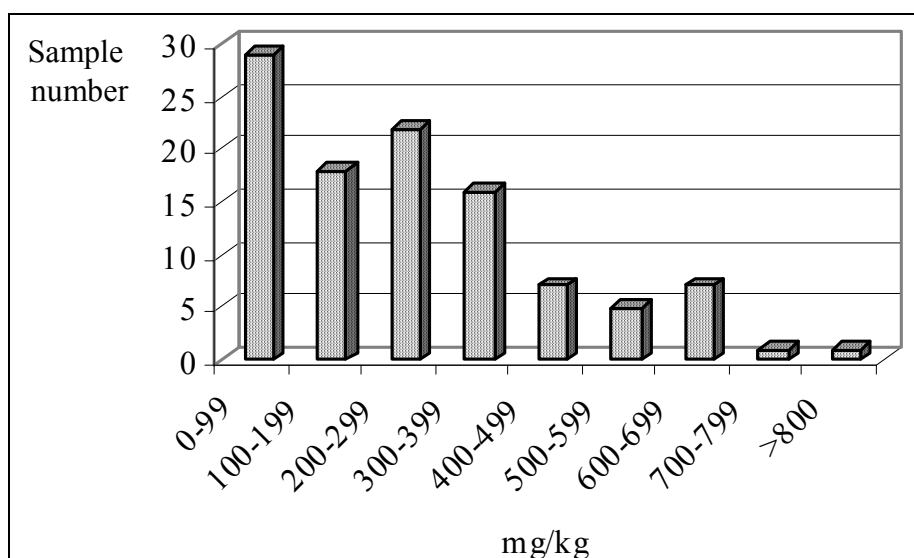

Figure 3.1: Distribution of released fluoride in the Italian brick and roof tile industry

Similar variations occur in chloride emissions (see Table 3.2), and also the distribution of released chloride with respect to the final product for the Italian brick and roof tile industry is shown in the following figure [20, CERAME-UNIE, 2004], [23, TWG Ceramics, 2005].

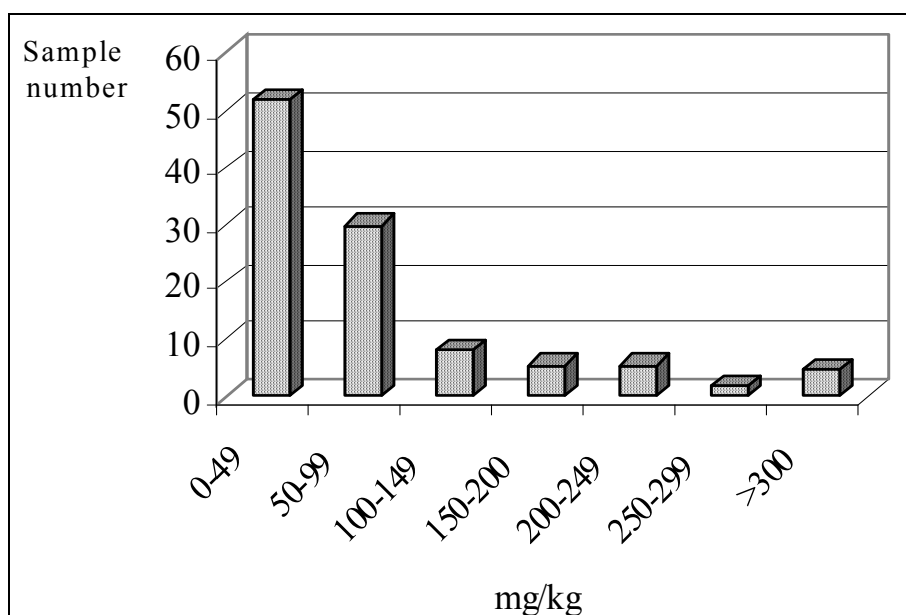

Figure 3.2: Distribution of released chloride in the Italian brick and roof tile industry

The following table shows the different sulphur emissions in Germany, UK and Belgium, shown as a relation between the number of brick and roof tile works and the corresponding emission ranges. Also here, the variation of the sulphur content in the clays (see Figure 2.12) plays an important role, e.g. by using clays with a low sulphur content, the ranges of sulphur emissions are lower than by using clays with high sulphur content. [20, CERAME-UNIE, 2004], [23, TWG Ceramics, 2005], [30, TWG Ceramics, 2005].

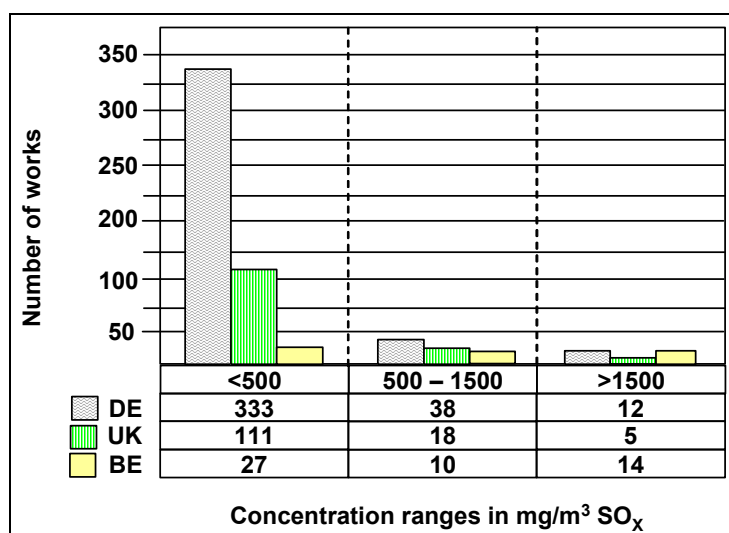

Figure 3.3: SO_x emissions in Germany, United Kingdom and Belgium

Ranges of operating data of raw gases are presented in the following table in correlation to the applied fuels [4, UBA, 2001],[27, VDI, 2004], [30, TWG Ceramics, 2005].

Emission component	Unit	Gaseous fuel	Fuel oil EL	Heavy fuel oil	Coal
Dust	mg/m ³	1 – 20	1 – 30	5 – 50	30 – 150 ^{***)}
NO _x stated as NO ₂	mg/m ³	20 – 200	20 – 200	20 – 200	20 – 200
SO _x stated as SO ₂ (S content of raw material <0.12 % ^{*)})	mg/m ³	10 – 300 ^{**)}	10 – 300 ^{**)}	30 – 500 ^{**)}	30 – 500 ^{**)}
Inorganic gaseous fluorine compounds stated as HF	mg/m ³	1 – 20 ^{**)}	1 – 20 ^{**)}	1 – 20 ^{**)}	1 – 20 ^{**)}
Inorganic gaseous chlorine compounds stated as HCl	mg/m ³	1 – 120	1 – 120	1 – 120	1 – 120
^{*)} Possible values above 1500 mg SO ₂ /m ³ with a raw material S content >0.12 % ^{**)} Lower HF and SO ₂ values are possible, if raw materials with a high lime content are used ^{***)} When using brown coal, dust contents up to 700 mg/m ³ may occur					

Table 3.3: Operating data of raw gas with various fuels

For the other fuels mentioned in Section 2.3.1.5, e.g. petroleum coke, no emission data are available.

VOCs are not necessarily present in all raw flue-gases of brick firing processes, they mainly occur where organic additives are used to develop porosity. These organic components in the raw flue-gas depend on the degree of porosity and the operation conditions in the preheating zone of the kiln. Often a mixture of different pore-forming agents is employed. The following table shows ranges of raw gas values obtained using various pore-forming agents [4, UBA, 2001].

Emission component	Unit	Polystyrene	Sawdust and paper binding agents
Organic substances stated as total C	mg/m ³	50 – 250	50 – 250
Benzene	mg/m ³	1 – 65	1 – 5
Phenol	mg/m ³	1 – 5	1 – 20
Formaldehyde	mg/m ³	1 – 20	5 – 100
Aldehyde (C1 – C4)	mg/m ³	1 – 20	25 – 180
Carbon monoxide ^{*)}	mg/m ³	<300	<1500

^{*)} A high CO -value is an indication of incomplete combustion

Table 3.4: Raw gas values with various pore-forming agents

The examples of clean gas values shown in the following table are average values in the manufacture of porous clay blocks and no information about the operated flue-gas cleaning units is available. The corresponding operating data ranges can be found in the upper section of the table. The table also shows the principle link between operating data, emission concentrations and the corresponding emission factors (emissions referring to the production of one kilogram brick (kg_B)) [4, UBA, 2001], [23, TWG Ceramics, 2005], [30, TWG Ceramics, 2005].

Source of emission	Tunnel kiln
Flue-gas volume flow (m ³ /h)	5000 – 50000
Flue-gas temperature (°C)	100 – 200

Emission component	Average clean gas concentration (mg/m ³)	Emission factor, average value (mg/kg _B)
Dust	11.6	17.6
NO _x stated as NO ₂	121.0	184.0
SO _x stated as SO ₂	26.1	39.6
CO ₂	98200	149000
CO	124.6	189.0
Inorganic gaseous fluorine compounds stated as HF	2.7	4.1
Inorganic gaseous chlorine compounds stated as HCl	8.4	12.7
Organic substances stated as total C	22.7	34.5

Table 3.5: Average clean gas concentrations (porous clay blocks) and corresponding product related emission factors

Table 3.6 and Table 3.7 show examples of flue-gas concentrations of clay block manufacturing masonry brick plants, facing brick plants and roof tile plants, measured by external technical experts (single and not continuous measurements) and the corresponding operating data in the upper sections of the tables. Most of the plants operate flue-gas cleaning systems, as stated in the tables, therefore the values represent clean gas concentrations [1, BMLFUW, 2003], [17, Burkart, 2004], [2, VITO, 2003].

Parameter	MB 1	MB 2	MB 3	MB 4	MB 5
Flue-gas volume flow (m ³ /h)	22000	12400	25300	12440	32930
Flue-gas temperature (°C)	153	107	224	171	197
Fuel	Natural gas	Natural gas	Natural gas	Natural gas	Natural gas
Pore-forming agent	Sawdust, polystyrene, paper	Sawdust	Sawdust, paper	Sawdust, sunflower shell, brown coal	Sawdust, polystyrene, paper, brown coal
Flue-gas cleaning	Thermal afterburning	–	Thermal afterburning	Thermal afterburning	Thermal afterburning

Emission component	MB 1	MB 2	MB 3	MB 4	MB 5
Dust	18.0	27.0	4.0	8.4	2.8
SO _x stated as SO ₂	26.0	<4.0	178.0	72.2	2.8
Fluorine stated as HF	3.0	<0.1	1.5	2.3	1.1
TOC without CH ₄	<5.0	19.0	11.5	11.9	4.0
Acetaldehyde	–	<1	–	–	–
Benzene	0.18	<0.10	0.18	0.11	0.30
Styrene	0.20	<0.10	0.14	0.03	0.90
Formaldehyde	0.005	<1.0	2.1	2.5	5.0
Phenol	0.12	<0.10	0.45	0.05	1.60
NO _x stated as NO ₂	98	18	113	162	187
Chlorine stated as HCl	13.5	<1.0	10.5	7.0	9.9
CO	14	300	–	–	25

MB: masonry brick plant; units in mg/Nm³ ref. to 18 % O₂, Nm³/h_{dry} or °C

Parameter	MB 6	MB 7	MB 8	MB 9	MB 10
Flue-gas volume flow (m ³ /h)	15100	20740	15420	27344	18300
Flue-gas temperature (°C)	131	155	153	102	186
Fuel	Natural gas	Natural gas	Natural gas	Natural gas	Natural gas
Pore-forming agent	Sawdust, paper, brown coal	Paper	Sawdust	Paper, polystyrene	Paper, polystyrene
Flue-gas cleaning	–	Thermal afterburning	–	Lime bed filter	Thermal afterburning

Emission component	MB 6	MB 7	MB 8	MB 9	MB 10
Dust	1.2	1.9	<1.0	10.7	0.9
SO _x stated as SO ₂	17.7	1.2	5.6	1.7	5.0
Fluorine stated as HF	0.9	0.1	1.8	<0.1	1.1
TOC without CH ₄	16.5	5.6	97.1	19.0	3.0
Acetaldehyde	–	–	–	<0.1	–
Benzene	4.7	1.5	3.0	0.4	0.1
Styrene	7.5	1.7	3.0	<0.1	2.0
Formaldehyde	11.7	4.5	10.6	<0.1	1.3
Phenol	5.6	2.3	6.1	<0.1	0.1
NO _x stated as NO ₂	24.2	64.8	43.0	33.6	73.0
Chlorine stated as HCl	2.4	1.2	5.0	<0.5	0.5
CO	–	39.2	–	–	44.0

MB: masonry brick plant; units in mg/Nm³ ref. to 18 % O₂, Nm³/h_{dry} or °C

Table 3.6: Clean gas concentrations of masonry brick plants

Parameter	KB 1	RT1	RT 2	RT 3/4	RT 5
Flue-gas volume flow (m ³ /h)	19500	13745	17214	31182	10500
Flue-gas temperature (°C)	165	84	159	154	202
Fuel	Natural gas	Natural gas	Natural gas	Natural gas	Natural gas
Flue-gas cleaning	Lime bed filter	Lime bed filter	Lime bed filter	Lime bed filter	Lime bed Filter

Emission component	KB 1	RT 1	RT 2	RT 3/4	RT 5
Dust	2.2	1.9	1.2	12.5	18.0
SO _x stated as SO ₂	6.8	17.1	9.6	<1.6	20.0
Fluorine stated as HF	1.4	4.5	<0.5	3.1	4.2
TOC without CH ₄	15.5	1.2	1.2	19.4	8.0
Formaldehyde	0.2	–	–	–	–
Benzene	2.5	–	–	–	–
Styrene	2.5	–	–	–	–
Phenol	5.0	–	–	–	–
NO _x stated as NO ₂	70.0	26.8	38.3	107.3	88.0
Chlorine stated as HCl	6.8	1.1	3.3	1.6	14.0
KB: facing brick plant, RT: roof tile plant; units in mg/Nm ³ ref. to 18 % O ₂ , Nm ³ /h _{div} or °C					

Table 3.7: Clean gas concentrations of clinker brick plants and roof tile plants

Table 3.8 and Table 3.9 show recent examples of clay block and facing brick manufacturing kilns in Belgium and the corresponding operating data [30, TWG Ceramics, 2005]. The plants apply different measures like process-integrated measures and end-of-pipe flue-gas cleaning techniques. Process-integrated measures include the addition of low sulphur raw materials, the addition of CaCO₃ and the addition of calcium rich additives. Therefore, the values shown in the tables are the raw gas values and the clean gas values (after process-integrated measures and flue-gas cleaning).

Parameter	Clay blocks 1	Clay blocks 2	Clay blocks 3	Clay blocks 4
Flue-gas volume flow	58682 m ³ /h	61027 m ³ /h	51838 m ³ /h	61156 m ³ /h
Flue-gas temperature	180 – 220 °C	180 – 220 °C	180 – 220 °C	180 – 220 °C
Fuel	Natural gas	Natural gas	Natural gas	Natural gas
Sulphur content in raw material-clay	0.5 – 0.75 %	>0.75 %	>0.75 %	>0.75 %
Pore forming agents	Sawdust	Sawdust	Sawdust	Sawdust
Process-integrated measures	Low sulphur and calcium containing raw materials	Low sulphur and calcium containing raw materials	Low sulphur and calcium containing raw materials	Low sulphur and calcium containing raw materials, calcium rich additives
Flue-gas cleaning	Dry flue-gas cleaning with filter	Cascade-type bed adsorbers	Cascade-type bed adsorbers	Cascade-type bed adsorbers
Adsorbent	Ca(OH) ₂	CaCO ₃	CaCO ₃	CaCO ₃

Emission components	Clay blocks 1			Clay blocks 2		
	Raw gas value mg/Nm ³	Clean gas values mg/Nm ³	Reduction efficiency %	Raw gas value mg/Nm ³	Clean gas values mg/Nm ³	Reduction efficiency %
Dust	36	3	92	117	71	39
SO _x as SO ₂	1436	1336	7	2051	1884	8
Fluorine stated as HF	25	1	96	56	2	96
Chlorine stated as HCl	5	11	0	11	9	18
NO _x	22	21	5	36	31	14
TOC	105	77	27	108	71	34
CO	1021	1235	0	988	1038	0

Emission components	Clay blocks 3			Clay blocks 4		
	Raw gas value mg/Nm ³	Clean gas values mg/Nm ³	Reduction efficiency %	Raw gas value mg/Nm ³	Clean gas values mg/Nm ³	Reduction efficiency %
Dust	127	26	80	165	69	58
SO _x as SO ₂	2883	2295	20	2893	2210	24
Fluorine stated as HF	36	3	92	35	6	83
Chlorine stated as HCl	7	3	57	9	7	22
NO _x	52	21	60	16	36	0
TOC	219	106	52	51	86	0
CO	936	905	3	1137	1165	0

Table 3.8: Raw gas and clean gas emission values in clay block manufacturing

Parameter	Facing brick 1	Facing brick 2	Facing brick 3	Facing brick 4
Flue-gas volume flow	56830 m ³ /h	16319 m ³ /h	35000 m ³ /h	22915 m ³ /h
Flue-gas temperature	230 °C	150 °C	110 °C	124 °C
Fuel	Natural gas	Natural gas	Natural gas	Natural gas
Sulphur content in raw material-clay	0.5 – 0.75 %	<0.25 %	<0.25 %	<0.25 %
Flue-gas cleaning	Dry flue-gas cleaning with filter	Cascade-type bed adsorbers	Cascade-type bed adsorbers	Cascade-type bed adsorbers
Adsorbent	Ca(OH) ₂	CaCO ₃	CaCO ₃	CaCO ₃

Emission components	Facing brick 1			Facing brick 2		
	Raw gas value mg/Nm ³	Clean gas values mg/Nm ³	Reduction efficiency %	Raw gas value mg/Nm ³	Clean gas values mg/Nm ³	Reduction efficiency %
Dust	9	14	0	19	12	37
SO _x as SO ₂	967	635	34	141	163	0
Fluorine stated as HF	21	1	95	23	6	74
Chlorine stated as HCl	6	1	83	3	3	0
NO _x	18	19	0	49	67	0
TOC	6	4	33	6	15	0
CO	110	129	0	177	135	24

Emission components	Facing brick 3			Facing brick 4		
	Raw gas value mg/Nm ³	Clean gas values mg/Nm ³	Reduction efficiency %	Raw gas value mg/Nm ³	Clean gas values mg/Nm ³	Reduction efficiency %
Dust	30	5	83	8	4	44
SO _x as SO ₂	150	36	76	27	10	63
Fluorine stated as HF	60	0.5	99	12	0.1	99
Chlorine stated as HCl	10	0.6	94	5	0.4	92.5
NO _x	100	64		110	98	11
TOC				4.1	4	2.4
CO	150	97		90.5	54	40.3

Table 3.9: Raw gas and clean gas emission values in facing brick manufacturing

Emissions to air do not only occur during the firing process, but also during these other manufacturing process steps [4, UBA, 2001], [23, TWG Ceramics, 2005]:

- during raw materials storage and internal transportation, dust emissions arise in the storage, weighing, transport and handling units
- dust emissions arise from the dry preparation process of clinker masses
- dust emissions arise from the shaping process of dry masses (pressing)
- dust emissions can arise from glazing and engobing processes, depending on the glazing or engobing technique applied
- some brick products such as calibrated bricks are ground after the firing process. Therefore, dust can also arise from dry grinding processes.

Emissions to water

Process waste water occurs in small quantities in the manufacture of bricks and roof tiles as cleaning water, if surface treatment such as glazing or engobing is carried out. Excessive glazes and engobes are collected and fed back to the production cycle. Additional amounts of process waste water can arise from the cleaning of raw material preparation units and moulds. Also, this water is often re-used in closed circuits [4, UBA, 2001], [23, TWG Ceramics, 2005]. Data regarding emissions to water are not available.

Process losses/waste

- broken ware can arise during the several manufacturing process steps (in particular shaping, drying, firing and subsequent treatment)
- sludge can arise from raw materials preparation (cleaning of units) only in small quantities and also from the cleaning of moulds and glazing or engobing units
- used and broken plaster moulds arise in the roof tile manufacturing process
- waste, such as plastics, waste paper and scrap metal, arises in the packaging process
- dust, sludge and used sorption agents are found in the off-gas cleaning units
- solid residues, e.g. ashes, arise from firing with solid fuels.

Parts of the accumulated process losses mentioned above, can be recycled and re-used within the plant due to product specifications or process requirements. Materials, which cannot be recycled internally, leave the plant to be used in other industries or to be supplied to external waste recycling or waste disposal facilities [4, UBA, 2001], [23, TWG Ceramics, 2005], [30, TWG Ceramics, 2005].

3.3.1.2 Consumption data

Energy consumption

The manufacture of clay bricks and roof tiles is energy intensive as they are manufactured by a high temperature process to convert the raw material into a material with totally different properties, the fired clay. Depending on the type of product, the share of energy costs in the total production costs generally varies between 17 and 30 % with maximum values up to 40 %. Natural gas is mostly used now as the energy source for kiln firing and accounts for nearly 90 % of the total energy consumption, but also liquefied petroleum gas, fuel oil, coal, petroleum coke, peat and electricity serve as the energy sources in some cases [13, SYKE, 2004], [17, Burkart, 2004], [23, TWG Ceramics, 2005], [30, TWG Ceramics, 2005].

The principal requirement for energy within the industry is for the process of transforming the clay into a durable form suitable for all types of construction. The energy consumption depends on the raw material, the manufacturing process and the product type in addition to the type of firing techniques employed. Although a particular firing process may be more energy efficient, it may not be suitable for the specific product.

Large variations are found in the specific energy consumption within Europe depending on the different construction and product types used. Each type of product has a specific energy consumption pattern due to the firing process (e.g. firing temperature, soaking time and setting density).

In Austria, Germany and Italy, where most houses are built with lightweight blocks, the energy used is low, i.e. 1.1 – 1.9 GJ/tonne. The lower density of the blocks is reached by the presence and/or the addition of pore-forming materials to the clay. These materials are mostly organic substances. They contribute to the energy balance of the clay brick production and, therefore, the specific primary energy consumption (natural gas, liquid fuel) is low.

Particularly in Northern Europe, a high number of facing bricks are used as an external layer. These bricks generally have a higher density and are often fired to a higher temperature than lightweight blocks. As a result, the specific energy consumption for the production of facing bricks is higher i.e. 2.5 – 2.7 GJ/tonne.

The large variation found in the United Kingdom (1.4 – 2.4 GJ/t) is due to the amount of organic material in the clay used to make bricks (large amount in lower Oxford clay for Fletton bricks and small amount for non Fletton bricks) [3, CERAME-UNIE, 2003].

Table 3.10 and Table 3.11 show examples of natural gas and electrical energy consumption data from installations for the manufacture of bricks and roof tiles in Austria and energy consumption data from Spain as well as the general specific energy consumption of the brick and roof tile industry [1, BMLFUW, 2003], [17, Burkart, 2004], [23, TWG Ceramics, 2005], [30, TWG Ceramics, 2005].

Energy source/consumption	Unit	Masonry bricks	Facing bricks	Roof tiles
Natural gas (AT)	GJ/t	1.02 – 1.87	2.87	1.97 – 2.93
Electrical energy (AT)	GJ/t	0.08 – 0.22	0.27	0.23 – 0.41
Energy consumption (ES)	GJ/t	1.50 – 2.50	2.50 – 3.00	1.90 – 2.95

Table 3.10: Energy consumption data per tonne of product from installations for the manufacture of bricks and roof tiles

Country	Unit	1980	1985	1990	1995	2000	2003
Austria	GJ/t	2.38	2.09	1.17	1.72	1.63	1.69
Belgium	GJ/t	3.3	3.19	2.16	2.45	2.59	2.21
Germany	GJ/t	2.43	2.31	1.93	1.63	2.57	2.31
Denmark	GJ/t	2.73	-	2.41	2.67	2.61	2.65
Spain	GJ/t	2.38	2.30	2.24	2.18	2.28	2.26
France	GJ/t	2.87	2.62	2.77	2.62	2.80	2.61
Italy	GJ/t	2.80	2.60	2.09	1.90	1.94	2.00
Netherlands	GJ/t	3.63	2.93	2.19	2.70	3.05	3.35
United Kingdom	GJ/t	2.29	2.16	2.48	2.63	3.25	2.85
Switzerland	GJ/t	-	2.56	2.62	2.53	2.44	-

Table 3.11: Specific energy consumption in the brick and roof tile industry

In this context, see also Table 2.2 and Table 2.4.

Water and raw material consumption

Example water and raw material consumption data of one plant for the manufacture of masonry bricks are shown in the following figure as a mass flow diagram [1, BMLFUW, 2003], [23, TWG Ceramics, 2005].

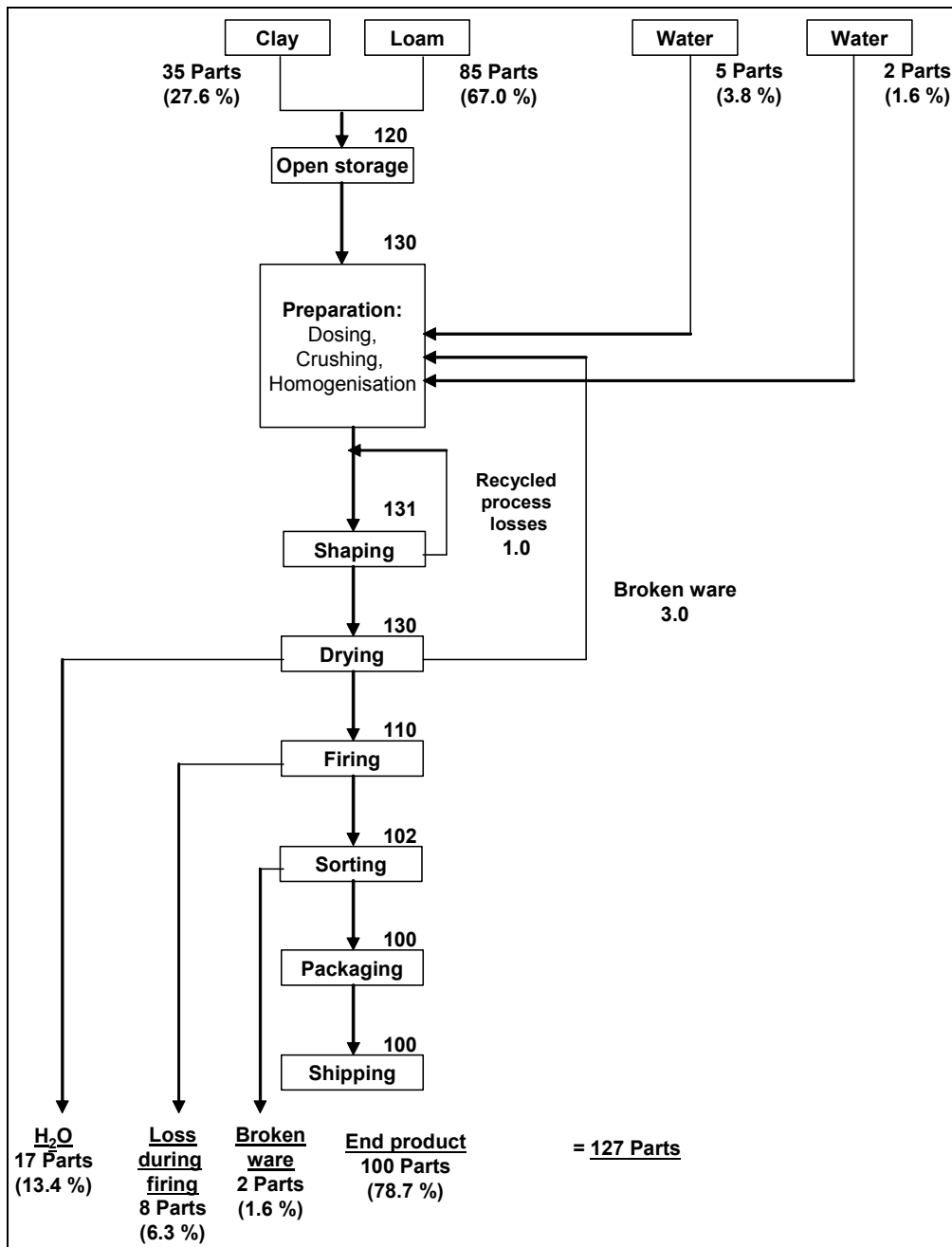

Figure 3.4: Mass flow example for the manufacture of masonry bricks

3.3.2 Vitrified clay pipes

3.3.2.1 Emission data

Emissions to air and water, process losses/waste and also noise emissions arise in the manufacture of vitrified clay pipes. In this section, ranges of air pollutant emissions are presented for the firing of vitrified clay pipes. Emissions to air from other process steps, emissions to water and process losses are also described.

Emissions to air

Significant emissions to air in the manufacture of vitrified clay pipes arise in the firing process.

In the following table, the maximum clean gas values emitted by European vitrified clay pipe plants (except for UK) and the corresponding tunnel kiln operating data (in the upper section of the table) are presented [3, CERAME-UNIE, 2003], [4, UBA, 2001].

Source of emission	Tunnel kiln
Flue-gas volume flow (m ³ /h)	4000 – 18000
Flue-gas temperature (°C)	160 – 200

Emission component	Maximum clean gas concentration (mg/m ³)
Dust	30
NO _x stated as NO ₂	200
SO _x stated as SO ₂	200
CO	200
Inorganic gaseous fluorine compounds stated as HF	5
Inorganic gaseous chlorine compounds stated as HCl	30

Table 3.12: Maximum concentration of clean gas in the manufacture of vitrified clay pipes

In the UK, maximum fluorine concentrations of up to 10 mg/m³ are observed due to the higher emission limit value of 10.

Emissions to air do not only occur during the firing process, but also during these other manufacturing process steps [4, UBA, 2001], [23, TWG Ceramics, 2005], [30, TWG Ceramics, 2005]:

- during raw materials storage and internal transportation, dust emissions arise in the storage, weighing, transport and handling units
- under certain circumstances, gaseous emissions can arise from the drying process. If excess heat from the kiln is employed in the drying process of green ware, which includes flue-gases from the firing zone and if there are no closed heating systems applied, fluoride emissions are possible
- if glazing is performed by spraying, dust emissions are possible from this process step
- some vitrified clay pipe products are ground after the firing process. Therefore, dust can also arise from dry grinding processes.

Emissions to water

In the manufacture of vitrified clay pipes, process waste water arises during the cleaning of raw materials preparation units and glazing units, as well as from wet grinding. The water is often re-used in closed circuits. Excessive glazes are collected and fed back to the production cycle. [4, UBA, 2001], [17, Burkart, 2004], [23, TWG Ceramics, 2005]. Data regarding emissions to water are not available.

Process losses/waste

- broken ware can arise during the several manufacturing process steps (in particular shaping, drying, firing and subsequent treatment)
- sludge arises from raw materials preparation (cleaning of units), from the cleaning of glazing units and also from wet grinding
- waste, such as plastics, waste paper and scrap metal arises in the packaging process
- dust, sludge and used sorption agents are found in the off-gas cleaning units.

Parts of the accumulated process losses mentioned above, can be recycled and re-used within the plant due to product specifications or process requirements. Materials, which cannot be recycled internally, leave the plant as waste and are supplied to external recycling or disposal facilities [4, UBA, 2001], [17, Burkart, 2004], [23, TWG Ceramics, 2005].

3.3.2.2 Consumption data

Energy consumption

The specific energy consumption in the manufacture of vitrified clay pipes is described in the following table. A distinction is made between the specific energy consumption for the provision of the mineral raw material and the energy, and for the manufacture of the pipes. The mineral materials are clay, opening agents and glaze, and the energy medium is natural gas. The electricity consumption, with regard to the primary energy, includes the entire manufacturing process including secondary plant units, lighting, etc. The data used are valid for about 90 % of German production. Consumption levels for small vitrified clay pipes (DN 100/DN 150), medium sized vitrified clay pipes (DN 200/DN 300) and large vitrified clay pipes (DN 500) are presented separately [4, UBA, 2001].

	DN 100, DN 150 (MJ/kg)	DN 200, DN 300 (MJ/kg)	DN 500, fittings (MJ/kg)
Provision			
Mineral raw materials	0.20	0.20	0.20
Natural gas	0.41	0.49	0.56
Production			
Preparation	0.10	0.10	0.10
Drying	1.22	1.44	1.66
Firing	3.06	3.60	4.14
Electricity	1.20	1.20	1.20
Total	6.19	7.03	7.86

Table 3.13: Specific energy consumption in the manufacture of vitrified clay pipes

In this context, see also Table 2.7.

Water and raw material consumption

Example water and raw material consumption data for the manufacture of vitrified clay pipes are shown in the following figure as a mass flow diagram [4, UBA, 2001].

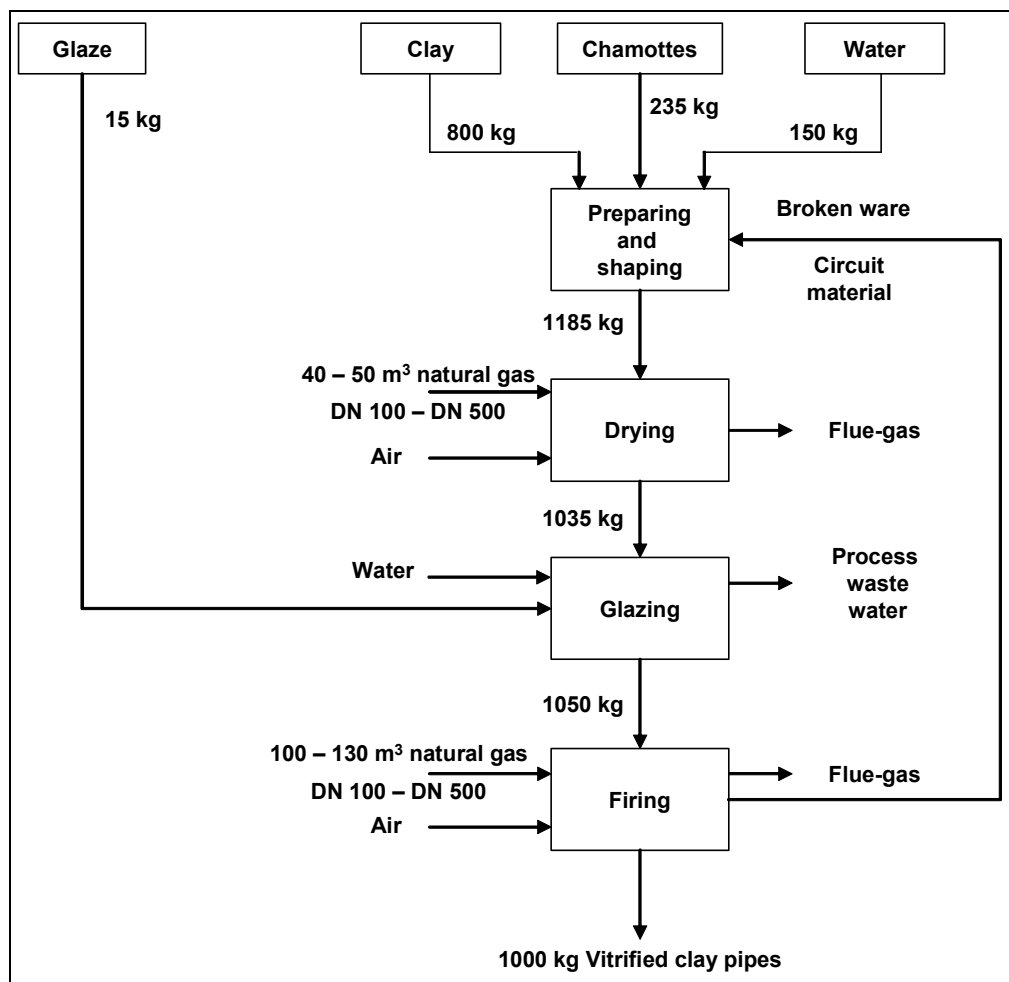

Figure 3.5: Mass flow example for the manufacture of vitrified clay pipes

3.3.3 Refractory products

3.3.3.1 Emission data

Emissions to air and water, process losses/waste and also noise emissions arise in the manufacture of refractory products. In this section, ranges of air pollutant emissions are presented for the firing of refractory products. Emissions to air from other process steps, emissions to water and process losses are also described.

Emissions to air

Significant emissions to air in the manufacture of refractory products arise in the firing process.

The following table shows ranges of operating data (in the upper section of the table) and corresponding raw gas values in tunnel kiln firing processes of different refractory products [4, UBA, 2001].

Source of emission	Tunnel kiln		
	Magnesite	High alumina	Silica
Product			
Flue-gas volume flow (m ³ /h)	15000 – 25000	9000 – 17000	8000 – 12000
Flue-gas temperature (°C)	250 – 400	120 – 250	150 – 250

Emission component	Concentration (mg/m ³)		
	Magnesite	High alumina	Silica
Product			
Dust	8 – 35	5 – 80	10 – 25
NO _x stated as NO ₂	110 – 470	30 – 250	5 – 100
SO _x stated as SO ₂	90 – 580	10 – 430	20 – 150
CO	12 – 180	30 – 150	10 – 50
Inorganic gaseous fluorine compounds stated as HF	0.5 – 1.5	5 – 50	1 – 3

Table 3.14: Raw gas values of different refractory products

The following table shows ranges of emissions from kilns for non-basic refractory products [3, CERAME-UNIE, 2003].

Emission component	mg/m ³
Dust	44 – 113
SO ₂	260 – 490
NO _x	25 – 200
Fluoride, HF	0.4 – 2.5
CO ₂	1 – 3 vol-%

Table 3.15: Emissions from kilns for non-basic refractory products

In special procedures (formation of carbon bondings, pitch impregnation), specific decomposition products (ammonia, formaldehyde, phenol, etc.) are formed depending on the special binding agents (coal tar, pitch, resin). Examples of raw gas values for special procedures are presented in the following table [4, UBA, 2001].

Emission component (mg/m ³)	Hardening chamber	Tempering kiln		Pitch coating
		Resin bonding ^{*)}	Pitch bonding ^{**)}	
	Resin bonding^{*)}	Resin bonding^{*)}	Pitch bonding^{**)}	Pitch bonding^{**)}
Ammonia	2500	20	–	–
Formaldehyde	25	10	–	–
Phenol	350	80	–	–
Organic substances stated as total C	>3000	1000	2500	1500
*) Phenol-resol-resin				
**) Values for total C include polycyclic aromatic hydrocarbons (PAH)				

Table 3.16: Raw gas values for special procedures

Emissions to air do not only occur during the firing process, but also during these other manufacturing process steps [4, UBA, 2001], [23, TWG Ceramics, 2005]:

- during raw materials storage and internal transportation, dust emissions arise in the storage, weighing, transport and handling units
- dust emissions arise from dry raw material preparation processes
- dust emissions and also vapours from binding agents and additives arise during shaping in presses
- under certain circumstances, gaseous emissions can arise from the drying process. If excess heat from the kiln is employed in the drying process of green ware, which includes flue-gases from the firing zone, and if there are no closed heating systems applied, emissions of organic and inorganic air pollutants are possible
- some refractory products are ground after the firing process. Therefore, dust can also arise from dry grinding processes.

Emissions to water

In the manufacture of refractory products, process waste water can arise during the cleaning of raw materials preparation units and casting units, as well as from wet grinding. The water is often re-used in closed circuits [4, UBA, 2001], [23, TWG Ceramics, 2005]. Data regarding emissions to water are not available.

Process losses/waste

- broken ware can arise during the several manufacturing process steps (in particular shaping, drying, firing and subsequent treatment)
- sludge can arise from raw materials preparation (cleaning of units), from the cleaning of casting units and also from wet grinding
- used and broken plaster moulds can arise by applying a slip casting process
- waste, such as plastics, waste paper and scrap metal arises in the packaging process
- dust, sludge and used sorption agents are found in the off-gas cleaning units.

Parts of the accumulated process losses mentioned above, can be recycled and re-used within the plant due to product specifications or process requirements. Materials, which cannot be recycled internally, leave the plant as waste and are supplied to external recycling or disposal facilities [4, UBA, 2001], [23, TWG Ceramics, 2005].

3.3.3.2 Consumption data

Energy consumption:

The following table shows ranges of specific energy consumption data for the different steps in the manufacture of magnesia refractory bricks [1, BMLFUW, 2003], [17, Burkart, 2004].

Process	MJ/kg
Preparation, screening	0.35 – 0.50
Weighing, dosing, mixing	0.045 – 0.070
Shaping	0.13 – 0.20
Drying, firing	3.0 – 6.3
Subsequent treatment, packaging	0.08

Table 3.17: Energy consumption data for the manufacture of magnesia refractory bricks, regarding kg of product

In this context, see also Table 2.9, Table 2.10, Table 2.11 and Table 2.12.

Water and raw material consumption

Example water and raw material consumption data for refractory products are shown in the following figure as a mass flow diagram for the manufacture of periclase chromite bricks [4, UBA, 2001].

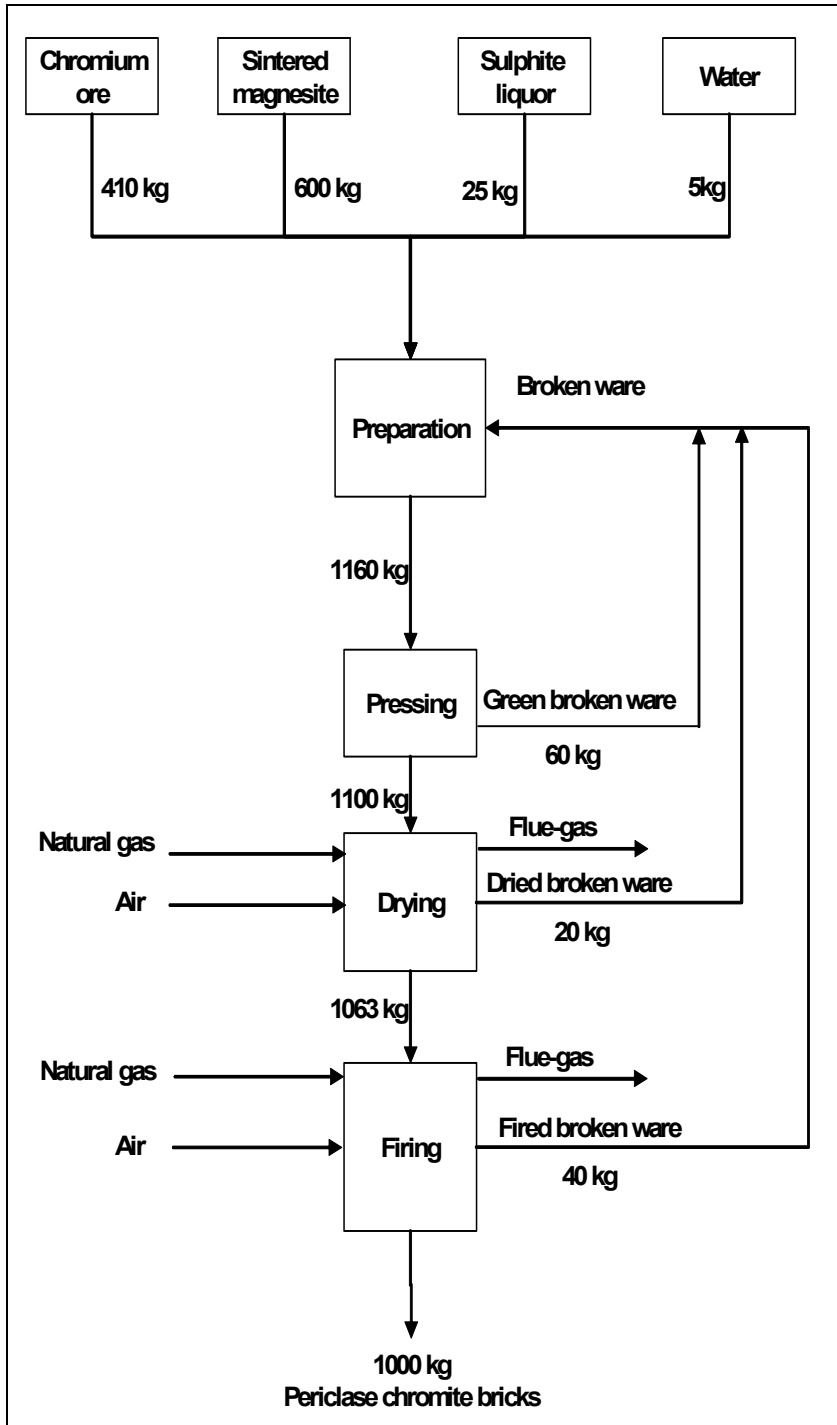

Figure 3.6: Mass flow example for the manufacture of periclase chromite bricks

3.3.4 Expanded clay aggregates

3.3.4.1 Emission data

Emissions to air and water, process losses/waste and also noise emissions arise from the manufacture of expanded clay aggregates. In this section, ranges of air pollutant emissions are presented for the process steps primary crushing, dry grinding, granulation, the firing process, screening and sand processing. Emissions to air from other process steps, emissions to water and process losses are also described.

Emissions to air

Significant emissions to air in the manufacture of expanded clay aggregates arise from storage, during raw material transport, primary crushing and dry grinding of raw clay, granulation, during the firing process (actual expansion), and also from screening and sand processing. From the storage and handling of raw materials and light weight aggregate (LWA) stock, and from on-site vehicle traffic, the emissions are mainly of a diffuse nature.

Raw material storage and transport:

During raw material storage and transport, dust emissions occur at transfer points in conveyor and storage systems depending on the raw material characteristics.

Primary crushing:

The primary crushing operation, which is applied in the technique for rather dry clay types (semi-dry process), leads to dust emissions. The following table shows ranges of dust emission values, originating from primary crushing downstream of a fabric filter [26, UBA, 2005].

Primary crushing	Values
Dust	0.7 – 3.4 mg/m ³ ¹⁾
¹⁾ Based on dry off-gas (273 K, 1013 hPa)	

Table 3.18: Ranges of dust emission values from primary crushing downstream of a fabric filter

Dry grinding:

During the dry grinding process, which is applied in the technique for rather dry clay types, sulphur dioxides and nitrogen oxides from the combustion of heavy fuel oil are generated in addition to dust. The following table shows ranges of actual emission values, originating from dry grinding downstream of the respective filter system [26, UBA, 2005], [30, TWG Ceramics, 2005].

Dust downstream of electrostatic precipitator or fabric filter	6 – 50 mg/m ³ ¹⁾²⁾
Sulphur dioxide	0.02 – 0.20 g/m ³ ¹⁾
Nitrogen oxides, quoted as NO ₂	0.11 – 0.14 g/m ³ ¹⁾
¹⁾ Based on moist flue-gas and 17 % by vol O ₂ (273 K, 1013 hPa)	
²⁾ Annual average values	

Table 3.19: Ranges of actual emission values from dry grinding downstream of the respective filter system

Granulation:

Granulation, which is applied in the technique for rather dry clay types, leads to dust emissions. The following table presents ranges of dust emission values, originating from granulation downstream of a fabric filter [26, UBA, 2005].

Granulation	Values
Dust	5 – 15 mg/m ³ ¹⁾
¹⁾ Based on dry off-gas (273 K, 1013 hPa)	

Table 3.20: Ranges of dust emission values from granulation downstream of a fabric filter

Firing process:

The process technology and the fuels used in the manufacture of expanded clay aggregates only have a limited influence on the emissions situation in a plant. The main parameter is the quality of the raw materials. Raw material-related organic and sulphur dioxide emissions (usually from pyrite and marcasite) in the raw gas are part of the actual expansion process.

The following table shows ranges of emission values, originating from firing and drying processes, downstream of the respective filter systems (electrostatic precipitator and wet flue-gas cleaning) [26, UBA, 2005] [28, Schorcht, 2005] [30, TWG Ceramics, 2005]:

Parameter	Unit	Emission value
Dust	mg/m ³	9 – 200
SO ₂	mg/m ³	200 – 2000
NO _x	mg/m ³	120 – 930
HCl	mg/m ³	2.7 – 250
HF	mg/m ³	0.4 – 20
CO	mg/m ³	50 – 2600
TOC	mg/m ³	10 – 800
Dioxins	ng/m ³	<0.1
Data given at normal O ₂ level 13 – 16 vol %. Only limited measurements for the components other than dust and SO ₂ .		

Table 3.21: Ranges of emission values from firing processes downstream of the respective filter systems

Another data set example of off-gas values from a firing process of expanded clay aggregates in a rotary kiln (Leca technique), which is equipped with an electrostatic precipitator for dedusting purposes, is reported as follows [17, Burkart, 2004]:

- dust: less than 50 mg/m³
- SO_x: 1700 – 1800 mg/m³ (sulphur content in the main raw material more than 0.75 %)
- fluorine, stated as HF: less than 5 mg/m³.

Screening and sand processing:

Dust emissions occur during screening of the different particle size groups and during sand processing. The following table shows a range of dust emission values of screening units [26, UBA, 2005], [30, TWG Ceramics, 2005].

Parameter	Screening unit I (with sand crusher)
Dust	4.3 – 50.0 mg/m ³

Table 3.22: Dust emission values of screening units

Emissions to water

Wet scrubbers are today used in some plants. The following table shows values on the effluent as weekly averages [30, TWG Ceramics, 2005].

Parameter	values
pH	6 - 9
Suspended solids	≤50 mg/l

Table 3.23: Effluent values of wet scrubbers

Water is mainly used in the preparation (and shaping) of raw materials.

Emissions to water are not relevant, because no process waste water is generated in expanded clay manufacturing. The cooling water for the kiln systems passes through an oil separator and is returned to the cooling circuit. All process water is evaporated in the drying process.

Process losses/waste

No process losses in the form of waste are generated in expanded clay manufacture. Screened oversized and undersized particles are returned to the sand crushers. All dust that is collected is returned to the manufacturing process. The gypsum generated during flue-gas cleaning is used in the cement industry as a hardening regulator.

3.3.4.2 Consumption data

Energy consumption

The energy consumption for dry grinding, which is applied in the processing of rather dry clay types (semi-dry process) is approx. 217 MJ/m³. This corresponds to approx. 20 % of the total thermal energy consumption for the overall manufacturing process of rather dry clay types (in the manufacturing process for clay with high moisture content, dry grinding is not carried out). Electrical energy consumption for dry grinding is approx. 26.3 MJ/m³.

The consumption of energy for the firing process is approx. 900 – 1300 MJ/m³, depending on the raw material (moisture content in the clay), production technology and production capacity [26, UBA, 2005], [30, TWG Ceramics, 2005].

The overall specific electrical energy consumption ranges between 43 and 83 MJ/m³, depending on the bulk weight, raw material properties and production technology (clay preparation, thermal process technology) [23, TWG Ceramics, 2005], [30, TWG Ceramics, 2005].

Water and raw material consumption

The following table gives an example of raw material mix use in the production of expanded clay aggregates [30, TWG Ceramics, 2005].

Material	Quantity % by weight	Purpose
Clay (dry)	>90	Raw material
Iron oxide	0 – 8	Flux
Limestone/dolomite powder	0.5 – 3	Release agent
Carbon carrier	0 – 1	Expansion agent

Table 3.24: Raw material mix in the production of expanded clay aggregates

3.3.5 Wall and floor tiles

3.3.5.1 Emission data

Emissions to air and water, process losses/waste and also noise emissions arise in the manufacture of glazed and unglazed wall and floor tiles. In this section, ranges of air pollutant emissions are presented for the main process steps. Emissions to air from other process steps, emissions to water and process losses are also described.

Emissions to air

The emissions from the milling of raw materials consist mainly of particles from raw materials such as clay, quartz and feldspar. In dry milling, the emission flowrate is about 6 Nm³ air per kilogram of processed raw material (PM) and the particulate matter (dust) emission factor is 50 g/kg PM. In wet milling, the emission flowrate is also about 6 Nm³ air/kg PM with an emission factor of about 15 g dust/kg PM. These emission factors refer to uncleaned off-gas streams.

Dust, nitrogen oxide, sulphur oxides, carbon monoxide and carbon dioxide arise as air pollutant emissions in the press granulate production process. Cleaning operations in the glazing section create aqueous suspensions, which contain ceramic materials. These suspensions are added to the drying slips. In the emissions arising from the drying slips, the elements boron, chlorine and lead have to be considered. The evaporation capacity of spray dryers goes up to 20000 l/h. The following table shows typical ranges of operating data (in the upper section of the table) and corresponding raw gas values of significant emissions, arising in the spray drying of body slip [3, CERAME-UNIE, 2003], [4, UBA, 2001], [10, Navarro, 1998], [23, TWG Ceramics, 2005].

Source of emission	Spray dryer
Flue-gas volume flow (m ³ /h)	30000 – 200000
Flue-gas temperature (°C)	60 – 130
Moisture (m ³ _{water} /m ³ _{total})	0.13 – 0.20
Oxygen (%)	16 – 20

Emission component	Concentration (mg/m ³)
Dust	150 – 1500
NO _x stated as NO ₂	5 – 300
CO	2 – 50
Chlorine compounds stated as HCl	1 – 5
Boron	<0.3
Lead	<0.15
CO ₂	1.5 – 4.0 vol-%

Table 3.25: Operating data and raw gas values of spray drying units

The use of spray drying facilities with cogeneration units is possible and convenient from an energy consumption point of view, but the raw flue-gas coming from these units usually contains more NO_x (range of between 50 – 800 mg/m³, stated as NO₂) [23, TWG Ceramics, 2005], [30, TWG Ceramics, 2005].

In the shaping of pieces by pressing, the emission flowrate is about 5 Nm³ air/kg PM and the emission factor is about 7 g dust/kg PM, referring to uncleaned off-gas. Depending on the size of the press, off-gas flows are between 2000 and 4000 m³/h at temperatures of between 20 and 30 °C. Additional dust emissions arise in polishing units after the press. In extrusion processes, only wet masses are processed, so no dust emissions can arise.

The following table shows ranges of operating data (in the upper section of the table) and corresponding emission ranges in uncleaned off-gas from dryers (the data correspond to vertical and horizontal dryers) [3, CERAME-UNIE, 2003], [10, Navarro, 1998], [23, TWG Ceramics, 2005], [21, Almeida, 2004].

Source of emission	Dryer
Flue-gas volume flow (m ³ /h)	2000 – 7000
Flue-gas temperature (°C)	50 – 190
Moisture (m ³ _{water} /m ³ _{total})	0.04 – 0.11
Oxygen (%)	16 – 20

Emission component	Concentration
Dust	5 – 25 mg/m ³
CO ₂	1 – 3 vol-%

Table 3.26: Operating data and raw gas values of dryers

The particulate matter found in dryer emissions is the result of dust particles attached to the body and dust arising from breaking tiles in dryers which drifts with the combustion gases. The relatively low temperatures in these facilities, usually of less than 300 °C, impede nitrogen oxide formation in this process.

Gaseous and particulate emissions arising in glazing depend on the application technique and on the composition of the glaze. In general, gaseous emissions can arise in the spraying process and in the glaze preparation process. The physico-chemical characteristics of these emissions are highly variable as a result of the great diversity in the glazes used. The dust arising in glazing and glaze preparation is characterised by the presence of silicon, boron, zirconium, sodium, lead, lithium, potassium, barium, calcium, magnesium, zinc and aluminium. The emission flowrate is about 5 Nm³ air/kg processed glaze and the emission factor is about 0.5 g dust/kg processed glaze, referring to uncleaned off-gas. The off-gas flow is up to 7000 m³/h at a temperature of approx. 30 °C.

In the following table, ranges of operating data (in the upper section of the table) and corresponding ranges of raw gas values of roller hearth kilns are presented [4, UBA, 2001], [10, Navarro, 1998], [23, TWG Ceramics, 2005], [21, Almeida, 2004].

Source of emission	Roller hearth kiln
Flue-gas volume flow (m ³ /h)	5000 – 15000
Flue-gas temperature (°C)	130 – 300
Moisture (m ³ _{water} /m ³ _{total})	0.05 – 0.1

Emission component	Concentration (mg/m ³)
Dust	5 – 30
NO _x stated as NO ₂	5 – 150
SO _x stated as SO ₂	1 – 300
CO	1 – 15
Fluorine compounds stated as HF	5 – 60
Chlorine compounds stated as HCl	20 – 150
Boron	<0.5
Lead	<0.15
CO ₂	1.5 – 4.0 vol-%

Table 3.27: Operating data and raw gas values in firing

A fluorine concentration in the clay of between 500 and 800 mg/kg leads to the fluorine emissions mentioned above. In the firing process, boron in the emission derives from the use of glaze which contains boron compounds. Boron and chlorine in the emissions can derive from the water in the tiles (boron derives only from recycled water and chlorine can also derive from fresh water from the public supply), which is subsequently evaporated in the first firing stages. The lead concentration is quite small and basically comes from the vaporisation of a minor group of glazes containing this element [4, UBA, 2001], [30, TWG Ceramics, 2005].

The following table, which is representative of the Italian situation, shows a comparison between pollutant emission factors for controlled emissions (clean gas values) and the corresponding pollutant emission factors for uncontrolled emissions (i.e. upstream of the pollution control plants) for the various steps (phases) of wall and floor tile manufacturing processes. The emission factors refer to the output unit of the corresponding phase [6, Timellini, 2004], [23, TWG Ceramics, 2005].

Gaseous emissions from		Specific flowrate (Nm ³ /kg)	Pollutant emission factors PEF (g/kg)					
Phase	Operation		Dust (particulate matter)		Lead compounds (Pb)		Fluorine compounds (HF)	
			UC	C	UC	C	UC	C
Body preparation	Dry grinding	6	40 – 60	0.05 – 0.1				
	Wet grinding	6	10 – 20	0.02 – 0.1				
	Spray drying	5	5 – 10	0.1 – 0.2				
Shaping	Pressing	5	5 – 10	0.01 – 0.05				
Glaze preparation and application		5	0.5 – 1.0	0.02 – 0.03				
Firing		3 – 6	0.1 – 0.5	0.01 – 0.02	0 – 0.1	0.001 – 0.01	0.1 – 0.5	0.01 – 0.05

UC = Uncontrolled emission; C = Controlled emission

Table 3.28: Gaseous emissions from the various phases of wall and floor tile manufacturing processes. Pollutant emission factors for uncontrolled (UC) and controlled (C) emissions

Emissions to air in the form of dust can also occur during raw materials storage and internal transportation, where dust emissions arise in the storage, weighing, transport and handling units. Wall and floor tiles are often ground after the firing process. Therefore dust can also arise from dry grinding processes [4, UBA, 2001], [23, TWG Ceramics, 2005].

Emissions to water

In the manufacture of wall and floor tiles, process waste water arises during the cleaning of raw materials preparation units and glazing units, as well as from the dewatering process with filter presses and rotation filters and from wet grinding. The water is often re-used in closed circuits. Excessive glazes are collected and fed back to the production cycle [4, UBA, 2001], [17, Burkart, 2004], [23, TWG Ceramics, 2005].

The following table gives details of a standard composition of untreated process waste water arising in wall and floor tile manufacturing facilities. The water is mainly cleaning water from the glazing units, so the concentration of substances depends to a large extent, on the composition of the glaze [3, CERAME-UNIE, 2003], [4, UBA, 2001], [10, Navarro, 1998].

Parameter	Range (mg/l)	Parameter	Range (mg/l)
pH	7 – 9	Calcium	5 – 500
Suspended matter	1000 – 20000	Boron	1 – 60
Settleable matter	5 – 30	Lead	<5
COD	100 – 400	Sodium	50 – 500
BOD ₅	40 – 60	Potassium	1 – 50
Fluorides	<2	Silicon	5 – 30
Chlorides	300 – 700	Aluminium	<2
Sulphates	100 – 1000	Iron	<0.5
Magnesium	10 – 100	Zinc	<2

Table 3.29: Chemical analysis of untreated process waste water

Process losses/waste

- broken ware can arise during the several manufacturing process steps (in particular shaping, drying, firing and subsequent treatment)
- sludge arises from raw materials preparation (in particular cleaning of units), from the cleaning of glazing units and also from wet grinding
- waste, such as plastics, waste paper and scrap metal, arises in the packaging process
- dust, sludge and used sorption agents are found in the off-gas cleaning units.

Parts of the accumulated process losses mentioned above, can be recycled and re-used within the plant due to product specifications or process requirements. Materials which cannot be recycled internally, leave the plant as waste and are supplied to external recycling or disposal facilities [4, UBA, 2001],[17, Burkart, 2004], [23, TWG Ceramics, 2005].

The quantity and composition of sludge from process waste water treatment units varies considerably due to the different manufacturing process types. The following table shows the ranges of the main chemical components of sludge [3, CERAME-UNIE, 2003],[4, UBA, 2001], [10, Navarro, 1998].

Substance	Range (wt-%)	Substance	Range (wt-%)
SiO ₂	40 – 60	K ₂ O	0.5 – 3.0
Al ₂ O ₃	5 – 15	TiO ₂	0 – 7
B ₂ O ₃	0 – 10	ZnO	1 – 8
Fe ₂ O ₃	0.1 – 5.0	BaO	0.1 – 3.0
CaO	5 – 15	PbO	0.1 – 15
MgO	0.5 – 3.0	ZrO ₂	1 – 15
Na ₂ O	0.5 – 3.0		

Table 3.30: Ranges of the main chemical components of sludge (manufacture of wall and floor tiles)

The quantity of sludge produced in a wall and floor tile facility ranges from 0.09 – 0.15 kg/m² finished product on a dry basis. For a product with a body mass of 15 – 20 kg/m², this figure corresponds to 0.4 – 1.0 % (kg dry sludge/kg ceramic body).

3.3.5.2 Consumption data

Energy consumption for spray drying

Typical thermal energy consumption values for the spray drying process of wall and floor tiles are in the range of 980 – 2200 KJ/kg [23, TWG Ceramics, 2005].

Energy consumption for drying

The heating power of burners in the dryer is generally low, because waste heat from the kiln is used for heating. Electrically heated dryers are operated to some extent. The flue-gas flow of an electrically heated dryer is only between 100 and 300 m³/h [4, UBA, 2001].

Typical thermal energy consumption values in the drying process of wall and floor tiles are in the range of 250 – 750 kJ/kg (based on the low calorific value of natural gas and the volume of gas at 15 °C and 1013 mbar). Regarding tiles of the class BIb-II, consumption values of more than 1400 kJ/kg are also possible [3, CERAME-UNIE, 2003].

Energy consumption for firing

In the following table, specific energy requirements of different types of kilns (tunnel kilns and roller hearth kilns) are compared. The values refer to a temperature of 1150 °C. The ranges of energy required are given for once-fired tiles (1x) and twice fired tiles (2x) [4, UBA, 2001], [23, TWG Ceramics, 2005].

Type of kiln	Range (kJ/kg)
Tunnel kiln (2x)	5920 – 7300
Tunnel kiln (1x)	5420 – 6300
Roller hearth kiln (2x)	3400 – 4620
Roller hearth kiln (1x)	1900 – 4800

Table 3.31: Examples of specific energy requirements of different kilns

In this context, see also Table 2.14.

The following table shows a comparison of the specific consumption of thermal energy and electrical energy per process step (phase). The data refer to the most significant Italian plants in terms of energy requirements [6, Timellini, 2004].

Phase	Operation	Specific natural gas consumption (GJ/t)	Specific electric energy consumption (GJ/t)
Body preparation	Dry grinding		0.04 – 0.07
	Wet grinding		0.05 – 0.35
	Spray drying	1.1 – 2.2	0.01 – 0.07
Shaping	Pressing		0.05 – 0.15
Drying		0.3 – 0.8	0.01 – 0.04
Firing		1.9 – 4.8	0.02 – 0.15

Table 3.32: Comparison of the specific consumption of thermal energy and electrical energy per process step

Water and raw material consumption

Depending on the raw materials used, the type of manufacturing process involved and the product properties desired, different amounts of water and raw materials are employed.

For example in dry body preparation, the raw material for the body is dry milled in a hammer mill or a pendular type of mill. The mixture is then wetted to 7 – 12 % on a dry weight basis. In this case, the granulated material is dried to a moisture content of 6 – 7 %.

In wet body preparation, the raw material of the body is wet milled in a ball mill by mixing with water to a moisture content of 42 – 50 % on a dry basis. Granulation subsequently takes place using a spray drying process and the granulated material is dried to a moisture content of 5 - 6 %.

It can be observed that when a wet process is used, water consumption is about four times higher than in the dry process. This means that the quantity of water employed, which can be re-used in the same body preparation process, is greater in the wet method than in the dry method [10, Navarro, 1998] [23, TWG Ceramics, 2005].

3.3.6 Table- and ornamentalware (household ceramics)

3.3.6.1 Emission data

Emissions to air and water, process losses/waste and also noise emissions arise in the manufacture of household ceramics. In this section, ranges of air pollutant emissions are presented for the process steps spray drying and firing. Emissions to air from other process steps, emissions to water and process losses are also described.

Emissions to air

The following table shows typical operating data and dust emission ranges of a spray dryer applied in the production of press granulate for the household ceramic industry.

Source of emission	Spray dryer
Flue-gas volume flow (m ³ /h)	up to 10000
Flue-gas temperature (°C)	60

Emission component	Concentration
Dust	20 – 30 mg/m ³

Table 3.33: Operating data and clean gas dust emission values of a spray dryer

Dust from the spray dryer is separated in a filter or in a combination of a cyclone and a wet separator. In this context, it should also be mentioned that in many modern household ceramic plants, spray dryers are nowadays no longer used, due to the fact that the suppliers deliver press granulate with the required parameters [4, UBA, 2001].

In the biscuit firing process, organic substances develop due to the decomposition or evaporation of auxiliary agents. They are emitted at a temperature of approximately 400 °C in the preheating zone of the kiln. Benzene can arise in this process in the range of 1 mg/m³ [3, CERAME-UNIE, 2003]. In the following table, ranges of operating data (in the upper section of the table) and corresponding raw gas compositions resulting from the firing of household ceramics in tunnel kilns are presented [4, UBA, 2001], [1, BMLFUW, 2003], [23, TWG Ceramics, 2005], [27, VDI, 2004], [21, Almeida, 2004].

Source of emission	Tunnel kiln
Flue-gas volume flow (m ³ /h)	3500 – 8000
Flue-gas temperature (°C)	130 – 200

Emission component	Concentration (mg/m ³)	Concentration (mg/m ³)
Firing	Biscuit firing	Glost firing
Dust	0.3 – 6.0	0.3 – 6.0
NO _x stated as NO ₂	13 – 110	20 – 150
Gaseous fluorine compounds stated as HF	1 – 35	0.3 – 23
Org. substances stated as total C	up to 40 ^{*)}	3 – 18

^{*)} In the case of isostatic pressing up to 100 mg/m³

Table 3.34: Raw gas values and operating data in household ceramics firing

The gaseous inorganic fluorine compounds, listed in Table 3.34, develop at temperatures of between 700 and 800 °C, due to the decomposition of certain substances in the raw materials. The progression of fluorine emissions from a tunnel kiln is constant, because of the continuously operated firing.

In the following table, operating data (in the upper section of the table) and corresponding raw and clean gas values (dust and HF concentrations) resulting from the firing of household ceramics with a tunnel kiln in a one time firing process are presented. In this special manufacturing process, the products are usually fired only once and pre-firing is unnecessary. The firing takes 20 hours at a temperature of 1260 °C and the flue-gas of the kiln is cleaned with a lime bed filter system [13, SYKE, 2004], [17, Burkart, 2004], [22, SYKE, 2004].

Source of emission	Tunnel kiln
Flue-gas volume flow (m ³ /h)	20000
Flue-gas temperature (°C) ^{*)}	137 – 156
O ₂ (%) ^{*)}	17.1 – 18.1

Emission component	Raw gas concentration (mg/m ³ ^{**)}	Clean gas concentration (mg/m ³)
Dust	0.9	0.9
Gaseous fluorine compounds stated as HF	7.0	0.224 – 0.293 ^{*)}
^{*)} Three measurements		
^{**)} Flue-gas temperature and O ₂ content not specified		

Table 3.35: Raw and clean gas values of a one time firing process of household ceramics

In periodically operated kilns, such as shuttle kilns, higher quantities of gaseous inorganic fluorine compounds are emitted at temperatures of between 800 and 1150 °C and their flue-gas volume flows amount from 5000 to 20000 m³/h.

Flue-gas from household ceramic firing processes also contains other air polluting substances such as CO, CO₂ and SO_x and if the ware is fired in an additional decoration process, emissions resulting from decoration firing also have to be considered. Glue and binders of transfer pictures or pitch of painting colours are burnt in decoration firing. Intensive smelling organic substances arise in this process. Additional heavy metal emissions from inorganic colour pigments (consisting of heavy metal oxides), can occur. The following table shows typical pigment systems, which are employed as decoration colours [4, UBA, 2001].

Colour	800 °C temperature resistance	1200 °C temperature resistance
Green	Chromium oxide, chromium-cobalt spinel	
Blue	Aluminium-zinc-chromium-cobalt spinel, cobalt melting	Zirconium-vanadium blue
Yellow	Lead-antimony yellow	Tin-vanadium yellow
Black	Spinel with iron, cobalt, nickel, manganese, chromium, copper, vanadium etc.	
Grey	Tin-antimony grey, zirconium-(cobalt, nickel) grey	
Brown	Iron-chromium-zinc-manganese spinel, iron oxide	Zirconium-iron pink
Red	Cassius purple, cadmium-(sulphur, selenium) red	Tin-chromium-(calcium, silicon) pink, cadmium red pigment
White	Cerium oxide, titanium oxide	Tin oxide, zirconium silicate

Table 3.36: Ceramic pigment systems used for decoration colours

The following table shows ranges of operating data and mass concentrations of heavy metal components arising from the decoration firing process of household ceramics [4, UBA, 2001].

Source of emission	Decoration firing kiln
Flue-gas volume flow (m ³ /h)	1000 – 3000
Flue-gas temperature (°C)	~100

Heavy metal component	Concentration (mg/m ³)
Lead	0.002 – 2.750
Cadmium	0.003 – 0.070
Cobalt	0.054 – 0.260
Nickel	0.060 – 0.400

Table 3.37: Concentrations of heavy metals in the raw gas of decoration firing

Emissions to air do not only occur during the spray drying and firing processes, but also during these other manufacturing process steps [4, UBA, 2001], [23, TWG Ceramics, 2005]:

- during raw materials storage and internal transportation, dust emissions arise in the storage, weighing, transport and handling units
- dust emissions arise from dry raw material preparation processes
- dust emissions arise from the shaping process of dry masses (pressing)
- under certain circumstances, gaseous emissions can arise from the drying process. If excess heat from the kiln is employed in the drying process of green ware, which includes flue-gases from the firing zone and if there are no closed heating systems applied, fluoride emissions are especially possible
- dust emissions can arise from glazing and engobing processes, depending on the glazing or engobing technique applied
- household ceramic products are often ground after the firing process. Therefore, dust can also arise from dry grinding processes.

Emissions to water

In the manufacture of household ceramics, process waste water arises during the cleaning of raw materials preparation units and casting units, from the glazing and decoration processes, as well as from the dewatering process with filter presses and rotation filters or from wet grinding. This process waste water contains the same components as the raw materials [4, UBA, 2001], [23, TWG Ceramics, 2005].

The following table shows the process waste water analysis of a porcelain tableware manufacturer [4, UBA, 2001], [1, BMLFUW, 2003]. Process waste water cleaning is carried out by homogenisation, flocculation, sedimentation, filtration in a sand bed and reverse osmosis for reducing the amount of process waste water.

Parameter	Unit	From plant	After thickener	After sand filter	Concentrate after reverse osmosis	Permeate after reverse osmosis
pH		7.5	7.5	7.5	8.0	6.5
Conducivity	µS/cm	750	700	680	950	8
Total hardness	dH	12.0	11.5	12.0	15.0	<0.5
Solid residue from evaporation at 135 °C	mg/l	1500	550	500	820	60
Chlorine	mg/l	150	150	130	245	<5
Sulphate	mg/l	100	100	110	280	<10
Phosphate	mg/l	80.0	2.0	1.0	1.5	0.4
Silicic acid	mg/l	200	15	10	25	<0.1
Calcium	mg/l	70	70	65	245	0.3
Magnesium	mg/l	9	7	7	23	<0.1
Boron	mg/l	2.0	1.0	1.0	3.1	<0.1
Zinc	µg/l	4500	<100	<100	<100	<100
Lead	µg/l	250000	200	60	110	<10
Cadmium	µg/l	60	2	2	3	<1
Cr, Cu, Ni, Co	µg/l	<0.05	<0.05	<0.05	<0.05	<0.05
AOX	mg/l	0.001	–	–	0.007	<0.001
COD	mg/l	30	–	–	45	<15

Table 3.38: Process waste water analysis of a porcelain tableware manufacturer

Another example of a process waste water analysis of a household ceramics plant, which operates mainly with an one time firing process and where the process waste water arises mainly from the glazing process and body preparation, is shown in the following table [13, SYKE, 2004], [17, Burkart, 2004], [22, SYKE, 2004].

Parameter	Unit	Concentration before treatment	Concentration after treatment	Reduction
pH		8.9	7.9	
BOD ₇	mg/l	7.4	5.4	27.0 %
COD _{Cr, O₂}	mg/l	142	25	82.4 %
Suspended solids	mg/l	8100	4.4	99.95 %
Cd	mg/l	0.0015	<0.0005	>66.7 %
Co	mg/l	12.0	0.020	99.83 %
Cr	mg/l	0.130	0.004	96.9 %
Cu	mg/l	0.110	0.029	73.6 %
Pb	mg/l	0.190	<0.010	>94.7 %
Zn	mg/l	4.0	0.220	94.5 %
Mn	mg/l	0.200	0.035	82.5 %

Table 3.39: Process waste water analysis of a household ceramics plant

Process waste water cleaning is carried out by a physico-chemical precipitation process, which consists of the following steps:

- equalisation basin
- addition of precipitation chemical and rapid mixing
- flocculation
- addition of cationic polymer and flocculation
- sedimentation
- thickening of sludge
- drying of sludge with a pressure filter.

The treated water is the overflow from the sedimentation basin and the corresponding waste water volume is 145 m³/day.

Process losses/waste

- broken ware can arise during the several manufacturing process steps (in particular shaping, drying, firing and subsequent treatment)
- sludge arises from raw materials preparation (in particular cleaning of units), from the cleaning of casting and glazing units and also from wet grinding
- used and broken plaster moulds can arise by applying a slip casting process
- waste, such as plastics, waste paper and scrap metal, arises in the packaging process
- dust, sludge and used sorption agents are found in the off-gas cleaning units.

Parts of the accumulated process losses mentioned above, can be recycled and re-used within the plant due to product specifications or process requirements. Materials, which cannot be recycled internally, leave the plant as waste and are supplied to external recycling or disposal facilities [4, UBA, 2001], [17, Burkart, 2004], [23, TWG Ceramics, 2005], [30, TWG Ceramics, 2005].

White sludge from process waste water treatment consists of a mixture of kaolin, other traditional ceramic raw materials and a modicum of plaster. An analysis of white sludge shows the following components: SiO₂ (66 – 70 %), Al₂O₃ (18 – 20 %), Na₂O (0.1 – 2 %), K₂O (3 - 3.5 %), CaO (1 – 3 %) [4, UBA, 2001].

3.3.6.2 Consumption data

Energy consumption

The following table shows the thermal and electrical energy consumption data of a porcelain tableware manufacturer [1, BMLFUW, 2003].

Parameter	Unit	Values
Electrical energy consumption	MJ/kg of product	4.5
Thermal energy consumption	MJ/kg of product	70

Table 3.40: Thermal and electrical energy consumption data of a porcelain tableware manufacturer

In this context, see also Table 2.17 and Table 2.18

Water and raw material consumption

Example water and raw material consumption data for tableware are shown in the following figure as a mass flow diagram [4, UBA, 2001], [23, TWG Ceramics, 2005]. The mass flow of non-decorated products, pre-dried by filter presses and manufactured on jiggering machines can be seen.

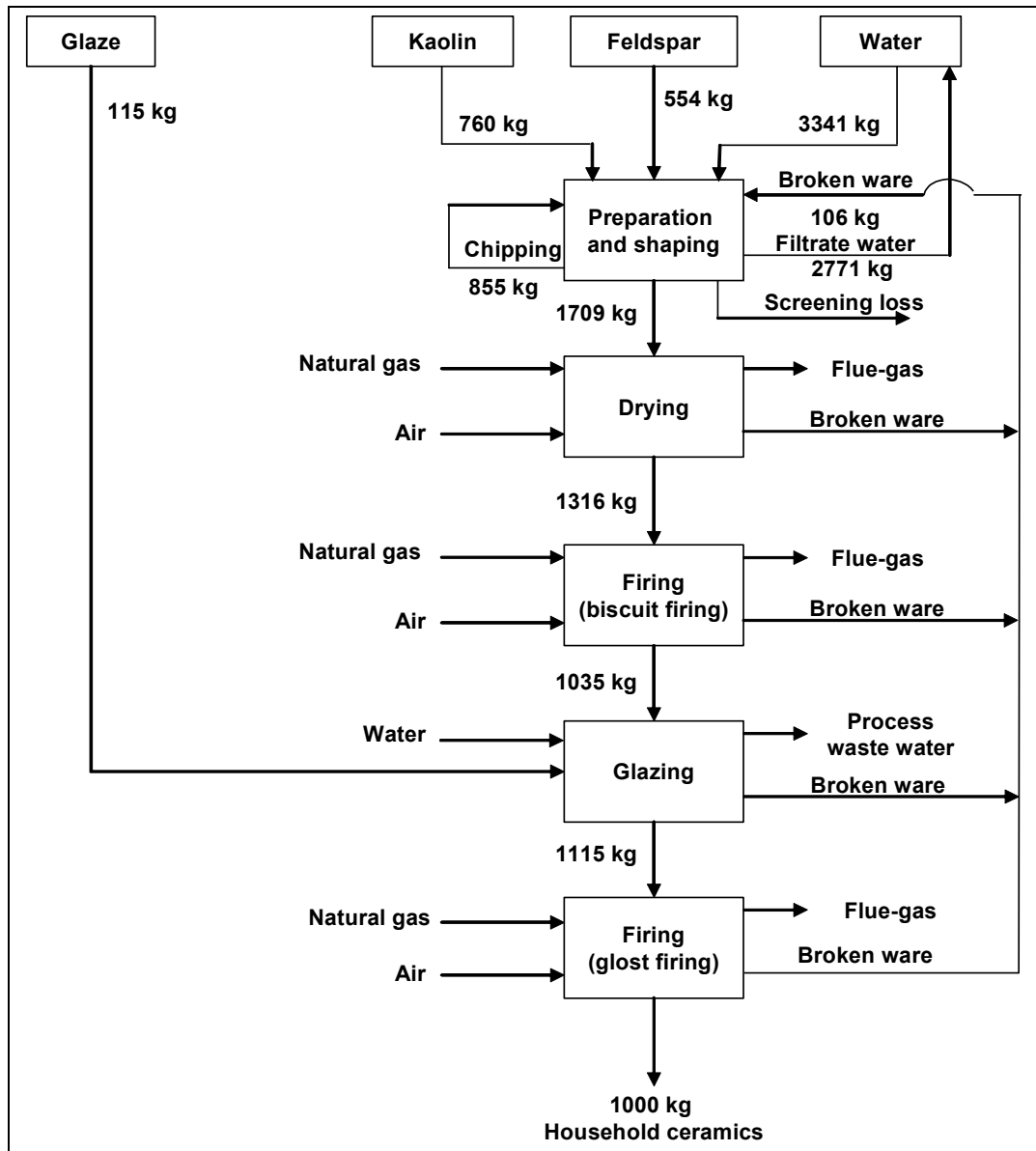

Figure 3.7: Mass flow example for the manufacture of tableware

3.3.7 Sanitaryware

3.3.7.1 Emission data

Emissions to air and water, process losses/waste and also noise emissions arise in the manufacture of sanitaryware. In this section, ranges of air pollutant emissions are presented for the firing of sanitaryware. Emissions to air from other process steps, emissions to water and process losses are also described.

Emissions to air

Sanitaryware is fired in tunnel kilns or roller hearth kilns. Small scale production is fired in periodically operated (intermittent) shuttle kilns. The following table shows the relevant raw gas and clean gas compositions as well as operating data (in the upper section of the table) of a tunnel kiln operated in a typical sanitaryware plant. In this example, the flue-gas is cleaned in a dry sorption process using planar honeycomb shaped adsorber modules, in a steel container [4, UBA, 2001].

Source of emission	Tunnel kiln
Flue-gas volume flow (m ³ /h)	9100
Flue-gas temperature (°C)	140 – 180

Emission component	Raw gas Concentration (mg/m ³)	Clean gas Concentration (mg/m ³)
Dust	10	3
NO _x stated as NO ₂	30	20
CO	200	200
Inorganic gaseous fluorine compounds stated as HF	1.3 – 3.6	0.4 – 1.5

Table 3.41: Example of raw and clean gas compositions from one tunnel kiln

The following table shows ranges of raw gas concentrations in tunnel and shuttle kilns (ref. to 18 % O₂, fuel: natural gas) [1, BMLFUW, 2003], [22, SYKE, 2004], [23, TWG Ceramics, 2005].

Emission component	Concentration (mg/m ³)	Concentration (mg/m ³)
Emission source	Tunnel kiln	Shuttle kiln
Dust	1 – 20	≤ 40
NO _x stated as NO ₂	10 – 50 ^{*)}	10 – 50
Inorganic gaseous chlorine compounds stated as HCl	1 – 25	≤ 80
Inorganic gaseous fluorine compounds stated as HF	1 – 30	≤ 90
SO ₂ ^{**))}	1 – 100	n.a.
^{*)} With fuel mixture LPG/heavy fuel oil up to 90 mg/m ³ NO ₂		
^{**))} With fuel mixture LPG/heavy fuel oil		

Table 3.42: Raw gas concentrations of tunnel and shuttle kilns

The following table shows examples of clean gas concentrations of two sanitaryware plants. The clean gas values were obtained after first firing in tunnel kilns and flue-gas treatment with lime packed bed adsorber systems (ref. to 18 % O₂, fuel: natural gas) [1, BMLFUW, 2003].

Emission component	Plant 1 Concentration (mg/m ³)	Plant 2 Concentration (mg/m ³)
Dust	3.2	5.0
Cobalt	<0.1	–
Nickel	<0.1	–
Chromium	<0.1	–
Manganese	<0.1	–
Vanadium	<0.1	–
Tin	<0.1	–
Antimony	<0.1	–
Inorganic gaseous fluorine compounds stated as HF	0.8	–
Inorganic gaseous chlorine compounds stated as HCl	0.8	–
SO _x stated as SO ₂	6.0	20

Table 3.43: Examples of clean gas concentrations of two sanitaryware plants

Emissions to air do not only occur during the firing process, but also during these other manufacturing process steps [4, UBA, 2001], [23, TWG Ceramics, 2005]:

- during raw materials storage and internal transportation, dust emissions arise in the storage, weighing, transport and handling units
- dust emissions can arise from dry preparation processes of hard raw materials
- under certain circumstances, gaseous emissions can arise from the drying process. If excess heat from the kiln is employed in the drying process of green ware, which includes flue-gases from the firing zone and if there are no closed heating systems applied, especially fluoride emissions are possible
- dust emissions can arise during the glaze spraying process
- dust emissions can arise from polishing and dry grinding processes.

Emissions to water

In the manufacture of sanitaryware, process waste water arises during the cleaning of raw materials preparation units and casting units, from the glazing process or from wet grinding. This process waste water contains the same components as the raw materials and can be re-used (mainly as cleaning water) [23, TWG Ceramics, 2005].

The following table shows an example of pollutant concentrations of cleaned process waste water and the corresponding daily loads from one sanitaryware plant (composite sample after sedimentation) [1, BMLFUW, 2003].

Parameter	Concentration (mg/l)	Load (g/day)
Zinc	0.05	1.0
Nickel	<0.01	<0.2
Lead	<0.01	<0.2
Copper	<0.01	<0.2
Chromium	<0.01	<0.2
Chromium-(VI)	<0.05	<0.01
Cobalt	<0.01	<0.2
Tin	<0.01	<0.2
Cadmium	<0.005	<0.1
Antimony	<0.01	<0.2
Barium	0.32	6.4
Sulphate	53	1060
pH	7.7	–

Table 3.44: Pollutant concentrations in cleaned process waste water

Process losses/waste

- broken ware can arise during the several manufacturing process steps (in particular shaping, drying, firing and subsequent treatment)
- sludge arises from raw materials preparation (in particular cleaning of units), from the cleaning of casting and glazing units and also from wet grinding
- used and broken plaster moulds arise from the slip casting process
- waste, such as plastics, waste paper and scrap metal, arises in the packaging process
- dust, sludge and used sorption agents are found in the off-gas cleaning units.

Parts of the accumulated process losses mentioned above, can be recycled and re-used within the plant due to product specifications or process requirements. Materials, which cannot be recycled internally, leave the plant as waste and are supplied to external recycling or disposal facilities [4, UBA, 2001], [17, Burkart, 2004], [23, TWG Ceramics, 2005].

White sludge from process waste water treatment consists of a mixture of kaolin, other traditional ceramic raw materials and a modicum of plaster. An analysis of white sludge shows the following components: SiO₂ (66 – 70 %), Al₂O₃ (18 – 20 %), Na₂O (0.1 – 2 %), K₂O (3 – 3.5 %), CaO (1 – 3 %) [4, UBA, 2001].

3.3.7.2 Consumption dataEnergy consumption

Ranges of specific energy requirements and further operating data of different kilns are presented in the following table [4, UBA, 2001] [23, TWG Ceramics, 2005] [27, VDI, 2004].

Type of kiln	Temperature (°C)	Firing time (h)	Specific energy requirement (kJ/kg)	Throughput (t/h)
Conventional tunnel kiln	1230 – 1270	16 – 24	9100 – 12000	0.8 – 1.0
Modern tunnel kiln with light fibre insulation	1230 – 1260	10 – 18	4200 – 6700	1.0 – 2.0
Roller hearth kiln	1230 – 1260	8 – 12	3500 – 5000	0.8 – 1.0
Modern shuttle kiln, repair firing	1180 – 1220	12 – 23	8300 – 10400	5 – 15 ^{*)}
Modern shuttle kiln, first firing	1240 – 1260	12 – 23	9200 – 11300	5 – 15 ^{*)}
^{*)} resp. (t/cycle)				

Table 3.45: Operating data and throughput of different kilns

In this context, see also Table 2.21, Table 2.22 and Table 2.23.

The following table shows examples of thermal and electrical energy consumption data of three sanitaryware plants [1, BMLFUW, 2003].

Parameter	Unit	Plant 1	Plant 2	Plant 3
Production capacity	t/yr	10000	5120	2900
Raw material use	t/yr	17000	7801	3500
Electrical energy consumption	MJ/kg product	0.36	3.32	3.16
Thermal energy consumption	MJ/kg product	30	22	28

Table 3.46: Energy consumption data

Water and raw material consumption

Example water and raw material consumption data for the manufacture of sanitaryware are shown in the following figure as a mass flow diagram [4, UBA, 2001], [23, TWG Ceramics, 2005]. The products are made of vitreous china and shaping is carried out in the slip casting process by the use of plaster moulds.

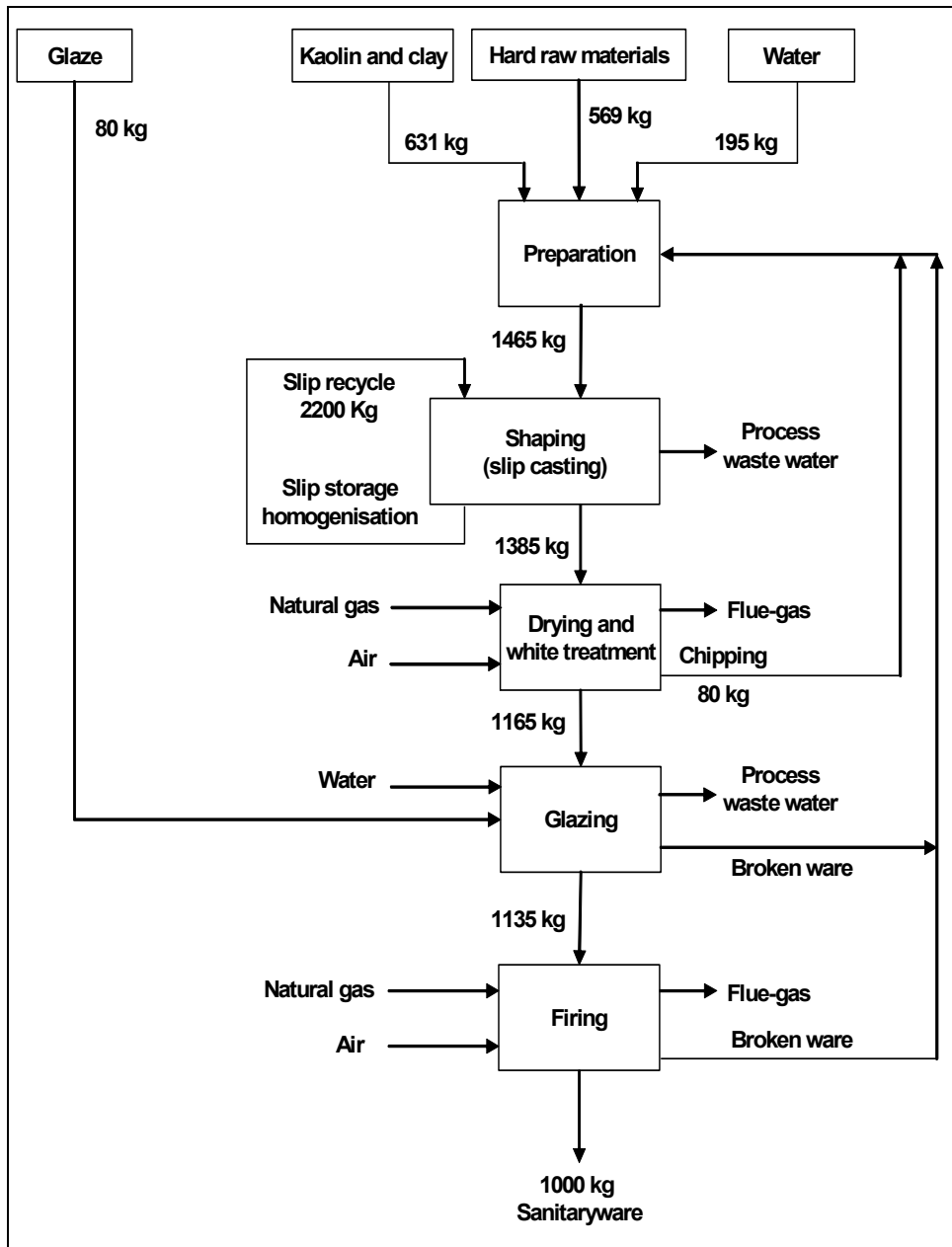

Figure 3.8: Mass flow example for the manufacture of sanitaryware

3.3.8 Technical ceramics

3.3.8.1 Emission data

Emissions to air and water, process losses/waste and also noise emissions arise in the manufacture of technical ceramics. In this section, ranges of air pollutant emissions are presented for the firing of electroporcelain. Emissions to air from other process steps, emissions to water and process losses are also described.

Emissions to air

The following table shows ranges of raw gas concentrations and mass flows from shuttle kilns during the firing of electrical insulators [1, BMLFUW, 2003].

Emission component ¹⁾	Concentration (mg/m ³)	Mass flow (g/h)
Dust	20 – 30	up to 600
NO _x stated as NO ₂	20 – 120	up to 2400
Inorganic gaseous fluorine compounds stated as HF	up to 120	up to 2400
¹⁾ ref. to 18 vol-% O ₂		

Table 3.47: Raw gas concentrations in the firing of electrical insulators

The following table shows an example of flue-gas concentrations from a shuttle kiln during the firing of electrical insulators. The kiln (see also Section 2.3.8) is not equipped with a flue-gas cleaning system [1, BMLFUW, 2003].

Emission component ¹⁾	Concentration (mg/m ³)	Mass flow (g/h)
CO	91	658
NO _x stated as NO ₂	39	282
Inorganic gaseous fluorine compounds stated as HF	11.3	82
Inorganic gaseous chlorine compounds stated as HCl	2.5	18
SO _x stated as SO ₂	2.8	20
Organic matter	6.3	45
¹⁾ ref. to 18 vol-% O ₂ , no measurement of particulates/dust		

Table 3.48: Flue-gas concentrations from a shuttle kiln during the firing of electrical insulators

Emission data regarding emissions to air from firing processes of other technical ceramics are not available, but if the technical ceramic bodies contain organic additives, VOCs can also arise during the firing process [17, Burkart, 2004].

Emissions to air do not only occur during firing processes, but also during these other manufacturing process steps [17, Burkart, 2004], [23, TWG Ceramics, 2005], [24, VKI-Germany, 2004]:

- during raw materials storage and internal transportation, dust emissions arise in the storage, weighing, transport and handling units
- dust emissions arise from dry raw material preparation processes
- dust emissions arise from shaping processes of dry masses (pressing)
- dust emissions arise from dry machining processes (green/white/hard machining)
- dust emissions can arise from glazing and engobing processes, depending on the glazing or engobing technique applied
- under certain circumstances, gaseous emissions can arise from the drying process. If excess heat from the kiln is employed in the drying process of green ware, which includes flue-gases from the firing zone and if there are no closed heating systems applied, gaseous emissions are possible
- from burning out and prefiring processes, gaseous emissions, especially VOCs, are possible.

Emissions to water

In the manufacture of technical ceramics, process waste water arises during the cleaning of raw materials preparation units and casting units, from the glazing and engobing processes, or from wet machining. This process waste water contains the same components as the raw materials [17, Burkart, 2004], [23, TWG Ceramics, 2005], [24, VKI-Germany, 2004].

The following table shows pollutant concentrations in cleaned process waste water from an electrical insulator manufacturer (see also Section 2.3.8) after flocculation, separation with a baffle plate thickener and filtration with a chamber filter press (five daily composite samples) [1, BMLFUW, 2003].

Parameter	Concentration (mg/l)				
	–	22	36	53	15
Filterable matter	–	<0.1	<0.1	<0.1	0.90
Aluminium	<0.01	–	–	–	–
Iron-II	<0.01	–	–	–	–
Iron-III	<0.01	2.64	1.15	0.056	0.1481
Total iron	–	0.33	–	–	–
Fluoride	–	19	–	–	–
COD	<0.05	1.60	–	–	–
TOC	8.12	6.24	5.87	6.65	7.37
pH					

Table 3.49: Concentrations in cleaned process waste water from an electrical insulator manufacturer

The following table shows pollutant concentrations in process waste water from an electric insulator manufacturer after flocculation without filtration (qualified sample) [23, TWG Ceramics, 2005].

Parameter	Unit	Value
pH	-	7.2
Suspended matter	mg/l	<3
COD	mg/l	53
TOC	mg/l	15
AOX	mg/l	0.02
Chromium (total)	mg/l	<0.01
Lead	mg/l	<0.05
Cadmium	mg/l	<0.005
Copper	mg/l	<0.01
Nickel	mg/l	<0.1
Zinc	mg/l	0.3
Aluminium	mg/l	0.23
Cobalt	mg/l	0.016

Table 3.50: Concentrations in process waste water from an electric insulator manufacturer after flocculation

The following table shows pollutant concentrations in cleaned process waste water from a manufacturer of piezoceramic products after final filtration, batch treatment (qualified sample) [23, TWG Ceramics, 2005].

Parameter	Unit	Value
pH	-	8.0
Suspended matter	mg/l	<3
COD	mg/l	597
TOC	mg/l	200
AOX	mg/l	<0.1
Lead	mg/l	<0.1
Cadmium	mg/l	<0.01
Copper	mg/l	<0.01
Nickel	mg/l	<0.1
Zinc	mg/l	0.04
Antimony	mg/l	<0.02

Table 3.51: Concentrations in cleaned process waste water from a manufacturer of piezoceramic products

Emission data regarding emissions to water from manufacturing processes of other technical ceramics are not available.

Process losses/waste

- broken ware can arise during the several manufacturing process steps (in particular shaping, drying, firing and machining)
- sludge arises from raw materials preparation (in particular cleaning of units), from the cleaning of casting, glazing and engobing units and also from wet machining
- used and broken plaster moulds can arise by applying a slip casting process
- machining emulsions can arise from mechanical surface treatment
- waste, such as plastics, waste paper and scrap metal, arises in the packaging process
- dust, sludge and used sorption agents are found in the off-gas cleaning units.

Parts of the accumulated process losses mentioned above, can be recycled and re-used within the plant due to product specifications or process requirements. Materials, which cannot be recycled internally, leave the plant as waste and are supplied to external recycling or disposal facilities [17, Burkart, 2004], [23, TWG Ceramics, 2005], [24, VKI-Germany, 2004].

3.3.8.2 Consumption data

Energy consumption

The following table shows examples of thermal and electrical energy consumption data from two plants manufacturing electroporcelain [1, BMLFUW, 2003].

Parameter	Unit	Plant 1	Plant 2
Electrical energy consumption	MJ/kg product	–	0.94
Thermal energy consumption	MJ/kg product	25	15.30

Table 3.52: Energy consumption data from two electroporcelain plants

The specific thermal energy consumption of a shuttle kiln with a kiln capacity of 70 m³ and a production capacity of 10 – 25 tonnes of electrical insulators per firing cycle amounts of between 12000 and 20000 kJ/kg [1, BMLFUW, 2003].

Energy consumption data from the manufacturing processes of other technical ceramics are not available.

Water and raw material consumption

The following table shows ranges of raw material compositions for the manufacture of electroporcelain (alumina porcelain). The range of the water content of the mass amounts to between 30 and 50 % [23, TWG Ceramics, 2005].

Raw material	Amount (%)
Kaolin	30 – 40
Clay	6 – 15
Feldspar	10 – 20
Quartz	0 – 30
Alumina	0 – 40

Table 3.53: Raw material compositions for the manufacture of electroporcelain

Water and raw material consumption data from the manufacturing processes of other technical ceramics are not available.

3.3.9 Inorganic bonded abrasives

3.3.9.1 Emission data

Emissions to air and water, process losses/waste and also noise emissions arise in the manufacture of inorganic bonded abrasives. In this section, ranges of air pollutant emissions are presented for the firing process, emissions to air from other process steps. Emissions to water and process losses are also described.

Emissions to air

The following table shows examples of flue-gas values from three plants in which inorganic bonded abrasives are manufactured (see also Section 2.3.9) [14, UBA, 2004], [30, TWG Ceramics, 2005].

Emission component	Unit	Plant 1 ¹⁾	Plant 2 ²⁾	Plant 3 ³⁾
CO ₂	t/yr	372	143	216
Dust	mg/m ³	12	<15	<15
TOC	mg/m ³	<43	39	<40
¹⁾ This plant is a typical example used for the manufacture of inorganic bonded abrasives (from the preparation of raw materials to the packaging of the abrasives). The abrasives are fired in a gas heated kiln with a capacity of 10.4 m ³ and an average setting density of 360 kg/m ³ . The following installation components are employed: bag filters for dust separation (for mixing and grinding units and for the finishing processes), thermal afterburning for flue-gas from the kiln and the common finishing units.				
²⁾ In this plant, the manufacture of small grinding tools is carried out. The plant is operated in one shift and the abrasives are fired in electrically heated shuttle kilns. The plant contains three identical shuttle kilns with a volume of up to 5.28 m ³ each (useable volume 4.4 m ³). The setting density varies between 700 and 1400 kg/m ³ (share of firing auxiliaries of between 33 – 50 %). The following installation components are employed: bag filters for dust separation (for mixing and grinding units and for the finishing processes), thermal afterburning for flue-gas from the kilns, sedimentation tanks for process waste water occurring from the cleaning of aggregates and the common finishing units.				
³⁾ This plant is an example of a small manufacturing unit of inorganic bonded abrasives (grinding wheels with a diameter size of 100 to 1000 mm). The abrasives are fired in a gas heated periodic shuttle kiln with a capacity of 5 m ³ and setting density of the vitrified bond between 70 and 140 kg/m ³ (see Section 2.3.9.5). The following installation components are also employed: bag filters are used for dust separation for mixing and grinding units and for the finishing processes.				

Table 3.54: Examples of flue-gas values from three plants in which inorganic bonded abrasives are manufactured

Emissions to air do not only occur during the firing process, but also during these other manufacturing process steps [14, UBA, 2004], [23, TWG Ceramics, 2005], [30, TWG Ceramics, 2005]:

- dust emissions can arise from dry raw material preparation, mixing and pressing processes
- dust emissions can arise from dry grinding processes.

Emissions to water

In the manufacture of inorganic bonded abrasives, only small amounts of process waste water occur. In some cases even a waste water free manufacture is possible (cleaning of the installation units by heating and abrading the contaminants). In the cases where process waste water occurs, this is predominantly cleaning water from installation units [14, UBA, 2004].

Process losses/waste

- broken ware can arise during the several manufacturing process steps (in particular shaping, drying, firing and subsequent treatment)
- sludge can arise in particular from cleaning of units
- machining emulsions can arise from shaping and mechanical surface treatment
- waste, such as plastics, waste paper and scrap metal arises in the packaging process
- dust, sludge and used sorption agents are found in the off-gas cleaning units.

Parts of the accumulated process losses mentioned above, can be recycled and re-used within the plant due to product specifications or process requirements. Materials, which cannot be recycled internally, leave the plant as waste and are supplied to external recycling or disposal facilities [14, UBA, 2004], [23, TWG Ceramics, 2005].

3.3.9.2 Consumption data

Energy consumption

In the following table, overall energy consumption data from the three inorganic bonded abrasives manufacturers mentioned in Table 3.54 are presented [14, UBA, 2004] [30, TWG Ceramics, 2005].

Parameter	Unit	Plant 1	Plant 2	Plant 3
Electrical energy consumption	kWh/yr	150000	1540000	175000
Natural gas consumption	kWh/yr	1850000	946000	1000000

Table 3.55: Overall energy consumption data from three inorganic bonded abrasives manufacturers

Water and raw material consumption

In the following table, water and raw material consumption data from the three inorganic bonded abrasives manufacturers mentioned in Table 3.54 are presented [14, UBA, 2004], [30, TWG Ceramics, 2005].

Input	Output	Plant 1 (t/yr)	Plant 2 (t/yr)	Plant 3 (t/yr)
Abrasive grains		216	440	153
Binding agents		35.2	110	17
Additives ¹⁾		15.2	41.8	7
Steel shafts and sleeves		-	17.6	-
	Product	253.6	550	170
	Abrasive dust	32	55	26
	Broken ware ²⁾	7	7	4
¹⁾ Partially decomposing during the firing process				
²⁾ Includes broken firing auxiliaries				

Table 3.56: Raw material consumption data from three inorganic bonded abrasives manufacturers

4 TECHNIQUES TO CONSIDER IN THE DETERMINATION OF BAT FOR CERAMIC MANUFACTURING

This chapter sets out techniques considered generally to have potential for achieving a high level of environmental protection in the industries within the scope of this document. Management systems, process-integrated techniques and end-of-pipe measures are included, but a certain amount of overlap exists between these three when seeking the optimum results.

Prevention, control, minimisation and recycling procedures are considered as well as the re-use of materials and energy.

Techniques may be presented singly or as combinations to achieve the objectives of IPPC. Annex IV to the Directive lists a number of general considerations to be taken into account when determining BAT and techniques within this chapter will address one or more of these considerations. As far as possible a standard structure is used to outline each technique, to enable comparison of techniques and an objective assessment against the definition of BAT given in the Directive.

The content of this chapter is not an exhaustive list of techniques and others may exist or be developed which may be equally valid within the framework of BAT.

Generally, a standard structure is used to outline each technique, as shown in Table 4.1:

Type of information considered	Type of information included
Description	Technical description of the technique
Achieved environmental benefits	Main environmental impact(s) to be addressed by the technique (process or abatement), including emission values achieved and efficiency performance. Environmental benefits of the technique in comparison with others
Cross-media effects	Any side-effects and disadvantages caused by implementation of the technique. Details on the environmental problems of the technique in comparison with others
Operational data	Performance data on emissions/wastes and consumption (raw materials, water and energy). Any other useful information on how to operate, maintain and control the technique, including safety aspects, operability constraints of the technique, output quality, etc.
Applicability	Consideration of the factors involved in applying and retrofitting the technique (e.g. space availability, process specific)
Economics	Information on costs (investment and operation) and any possible savings (e.g. reduced raw material consumption, waste charges) also as related to the capacity of the technique
Driving force for implementation	Reasons for implementation of the technique (e.g. other legislation, improvement in production quality)
Example plants	Reference to plants where the technique is reported to be used
Reference literature	Literature for more detailed information on the technique

Table 4.1: Information breakdown for each technique described in this chapter

As the boundaries between the elements mentioned above may overlap to a certain extent, the structure is kept flexible, reflecting the particular individual case.

The costs for abatement techniques have to be evaluated in relation to the size of the installations, the effectiveness of the techniques and the circumstances of the individual application. In this context, Table 4.7 gives examples about investment costs, maintenance costs, costs for sorbents and operational costs for the abatement of dust, inorganic gaseous compounds and organic gaseous compounds by using different abatement techniques [32, TWG Ceramics, 2006].

Regarding the standard conditions for measurements of volume flows and concentrations, see the following definitions, which are also stated in the Glossary:

m ³ /h	volume flow: if not otherwise mentioned in this document, the volume flows refer to 18 vol-% oxygen and standard state.
mg/m ³	concentration: if not otherwise mentioned in this document, the concentrations of gaseous substances or mixtures of substances refer to dry flue-gas at 18 vol-% oxygen and standard state, and benzene concentrations refer to 15 vol-% oxygen and standard state.
standard state	refers to a temperature of 273 K and a pressure of 1013 hPa.

4.1 Reduction of energy consumption (energy efficiency)

In this context, useful information can also be found in the Energy Efficiency Techniques reference document (ENE), which is currently being prepared.

4.1.1 Improved design of kilns and dryers

Description and achieved environmental benefits

Several different measures are presented here, which can be applied to kiln/dryer systems individually or in combination:

- automatic control of dryer circuits
- automatic control of humidity and temperature within the dryer
- in dryers, installation of impulsion fans distributed in zones with an independent thermal contribution (adjustable by zones) to get the necessary temperature
- better sealing of kilns, e.g. metal casing and sand or water seals for tunnel kilns and intermittent kilns, leads to reduced heat losses
- improved thermal insulation of kilns, e.g. by use of insulating refractory linings or ceramic fibres (mineral wool) leads to reduced heat losses
- improved refractory kiln linings and kiln-car decks reduce cooling downtime and hence associated heat losses ('exit losses')
- the use of high velocity burners improves combustion efficiency and heat transfer
- replacing old kilns with new, in size and width increased tunnel kilns or with the same capacity or – if possible in the manufacturing process – fast firing kilns (for instance roller hearth kilns), can lead to reduced specific energy consumption
- interactive computer control of kiln firing regimes leads to reduced energy consumption and also to a decrease of air pollutant emissions
- reduced use of firing auxiliaries and/or use of firing auxiliaries made of SiC/super alloys causes less energy input for heating the kiln system; SiC firing auxiliaries can also be applied in fast firing roller technology kilns
- optimisation (minimisation) of the passage between dryer and kiln and also using the preheating zone of the kiln for finishing the drying process – if possible in the manufacturing process – avoids unnecessary cooling of the dried ware before the firing process
- reducing the amount of airflow through the rotary kiln in the manufacture of expanded clay aggregates can reduce energy consumption.

Most of the measures mentioned above can also be applied to dryers, for instance regarding dryer design (improved thermal insulation, insulated doors or locks, etc.), the firing auxiliaries and the process control, particularly because dryers and kilns are very often connected with a heat recovery system (see Section 4.1.2).

Cross-media effects

No issues.

Operational data

This depends on the particular individual case related measure/task; for instance, the specific energy requirements for different products, fired in different kiln types (conventional, fast firing, with/without improved insulation) are compared in Table 2.14 (manufacture of wall and floor tiles), Table 3.31 (manufacture of wall and floor tiles) and in Table 3.45 (manufacture of sanitaryware).

Applicability

In principle, most of the measures mentioned above can be applied to all ceramic sectors, but the roller hearth technology for instance, is mainly applied for the manufacture of wall and floor tiles. However, roof tiles, vitrified clay pipes and sanitaryware can also be fired in roller hearth kilns (see Section 2.2.7.4.3).

Measures concerning especially shuttle, tunnel and roller hearth kilns (e.g. regarding kiln-cars and firing auxiliaries) cannot be applied to rotary kilns, in which expanded clay aggregates are manufactured (see Section 2.3.4). Also within the sectors, the applicability of the different kiln technologies depends on the manufactured products; for example, some types of wall and floor tiles need tunnel kilns for firing, to achieve the desired product properties.

Economics

Modernising the kilns and/or dryers being used or even replacing them with new less energy consuming alternatives like roller hearth kilns – if applicable – can result in considerable energy savings for companies. If they are replaced before the end of their useful life, this requires a substantial capital investment.

Driving force for implementation

- saving money by saving energy
- reduction of CO₂ emissions.

Example plants and reference literature

[1, BMLFUW, 2003], [3, CERAME-UNIE, 2003], [4, UBA, 2001], [23, TWG Ceramics, 2005], [26, UBA, 2005], [30, TWG Ceramics, 2005].

4.1.2 Recovery of excess heat from kilns

Description and achieved environmental benefits

Many ceramic dryers now use hot air recovered from the cooling zones of tunnel kilns, usually supplemented with hot air from gas burners, so the layout of the plant is very important. In particular, low temperature excess heat can only be managed usefully if the length of the pipes – i.e. the distance between excess heat generation and use – is quite limited. In any case, suitable heat insulation of the pipes is required. Very significant energy savings have been achieved in this way.

Some processes also employ heat exchangers to recover heat from kiln flue-gases in order to preheat the combustion air, but this application is limited, because of possible corrosion problems caused by acid combustion gases and often flue-gas temperatures that are too low.

Excess heat from an afterburner can also be used, either in the kiln or in the dryer. One German factory uses thermal oil to transfer excess heat from the afterburner to the dryer, in combination with hot air from the cooling zone of the kiln. The functioning principle of this combined heat recycling system is presented in the following figure [4, UBA, 2001].

Besides the use of excess heat (4) in the heat recovery boiler (5) and for the heating of the preheater (1), the heat resulting from the cooling of the cleaned flue-gas is recovered in a flue-gas heat exchanger (7) and fed to further heat exchangers (8) by thermal oil, to warm fresh air (9) for the drying process. The warm fresh air is mixed with hot air from the cooling zone (4) of the kiln (2) and fed to a continuously operated casing pallet dryer (11).

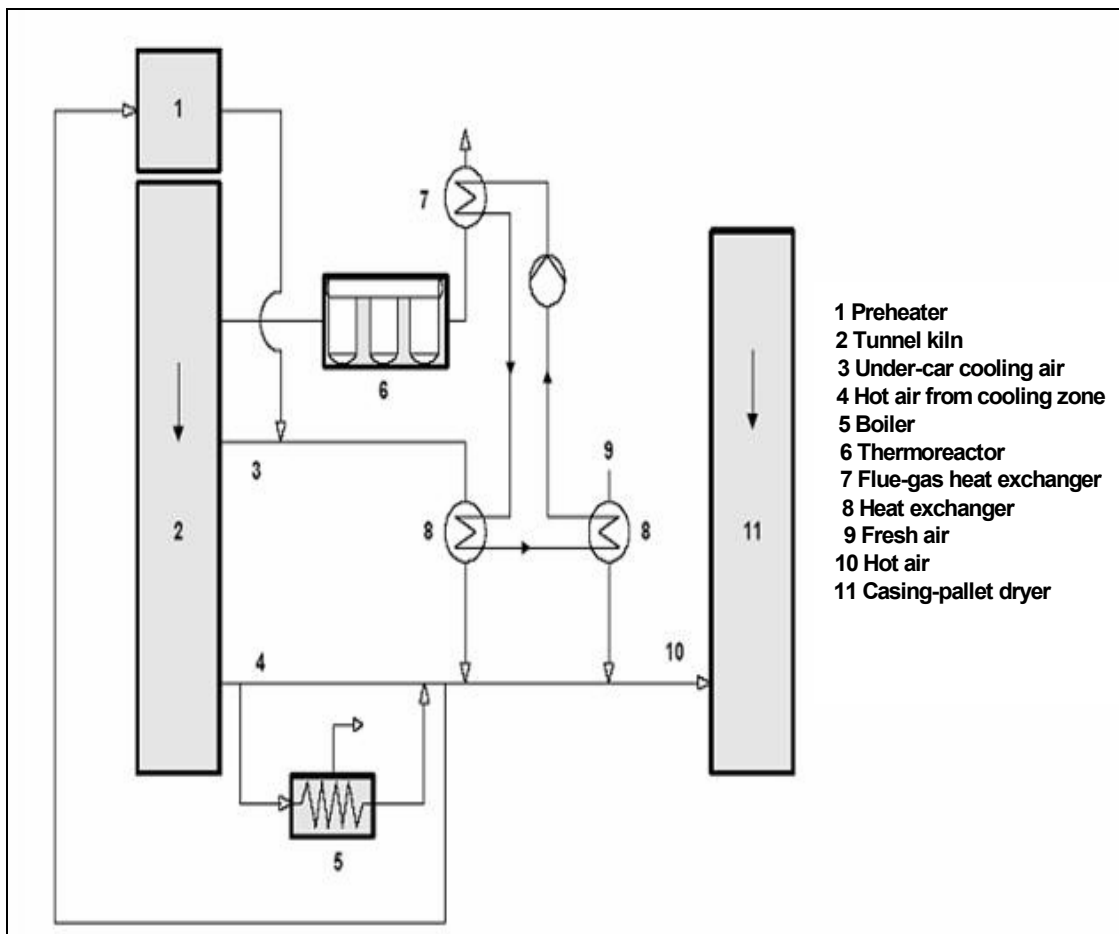

Figure 4.1: Schematic view of an example of a combined heat recycling system

Cross-media effects

Slightly increased electrical energy consumption is possible, particularly if heat exchange circuits are used.

Operational data

In the case of the combined heat recycling system shown above, the specific natural gas energy requirement for drying and firing is only between 840 and 1050 kJ/kg fired ware (bricks) [4, UBA, 2001], [30, TWG Ceramics, 2005].

Applicability

Recovery of excess heat from kilns, especially from their cooling zones in the form of hot air, can, in principle, be applied in all ceramic sectors to heat dryers. It should be noted, that recovery of excess heat from kilns is only applicable if the excess heat is needed at the same time in another process.

The specific example mentioned above (in Germany only very few factories use this technique) cannot be generalised, especially regarding the utilisation of the excess heat of the afterburner, because often the flue-gas from an afterburner is too cold to carry out efficient energy recovery.

Economics

- reduced energy consumption
- additional costs for pipe insulation have to be taken into account.

Driving force for implementation

- saving money by saving energy
- reduction of CO₂ emissions.

Example plants and reference literature

JUWOE POROTON-Werke Ernst Jungk & Sohn GmbH, Germany, brickwork [4, UBA, 2001], [1, BMLFUW, 2003], [2, VITO, 2003], [3, CERAME-UNIE, 2003], [23, TWG Ceramics, 2005], [30, TWG Ceramics, 2005]

4.1.3 Cogeneration/combined heat and power plants

Description, achieved environmental benefits and operational data

The employment of cogeneration plants for steam and electricity or of combined heat and power plants is, in principle, useful in the ceramic industry due to the simultaneous demand of heat and electric power. The essential feature of the cogeneration plant is the driving engine. Gas fuelled Otto engines, diesel engines and gas turbines with excess heat utilisation are suitable.

Figure 4.2 shows an example for the utilisation of excess heat from a combined heat and power plant for the production of hot air [4, UBA, 2001]. The hot air is used for the brickwork dryer. A proportion of fresh air is necessary for the dryer in addition to the kiln's excess heat. This air is generally taken in from the dryer building, in order to make use of the high radiation heat components of the kiln and the dryer. This fresh air is mixed with the excess heat from the kiln in front of the dryer feed fan. In the suction pipe for fresh air, an air heater is installed in order to maintain preheating of the fresh air. This heat exchanger is heated by the cooling water of the driving engines. The flue-gases have a temperature of 450 to 550 °C, depending on the type of engine. They are fed into the mixing chamber and used directly in the dryer. Any heat deficiency is covered by a supplementary gas burner. If no heat is required at the dryer, the uncooled flue-gases from the engines are withdrawn directly via a stack.

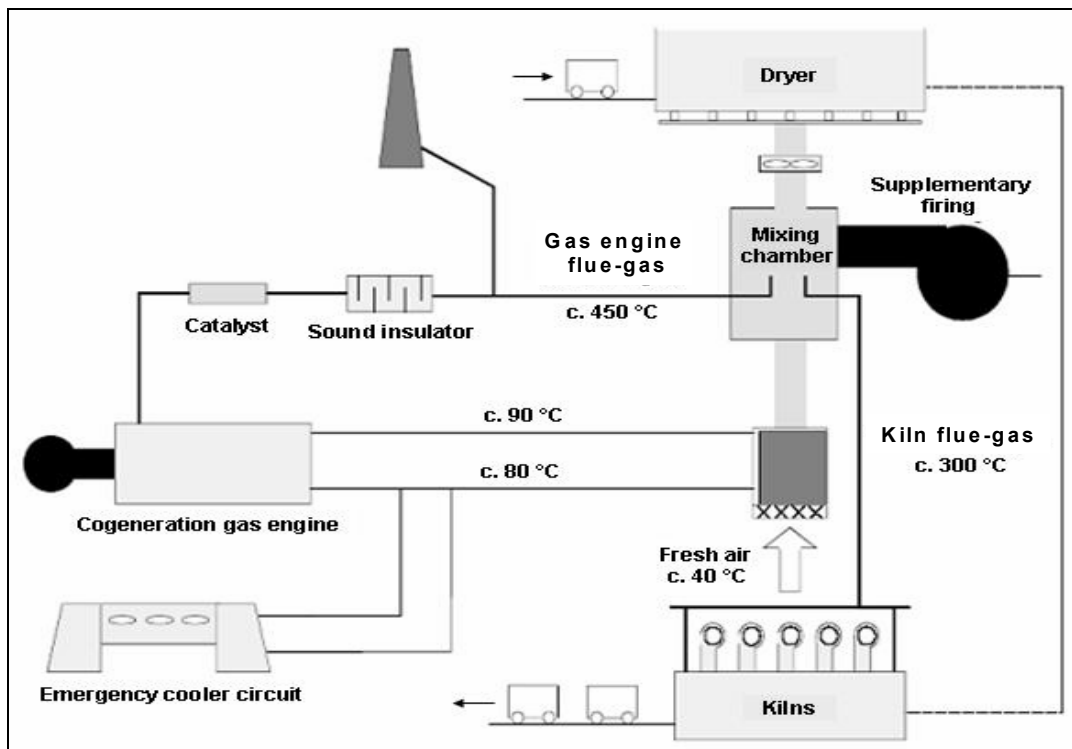

Figure 4.2: Schematic view of hot air generation using a cogeneration gas engine

In some cases, flue-gases, before being introduced in the mixing chamber, can also pass a boiler to produce vapour which is utilised in the extrusion phase.

Cross-media effects

Driving engines can cause additional emissions into air on site and noise also increases.

Applicability

The heat produced by the combined heat and power plants can be used in the spray drying process especially for the manufacture of wall and floor tiles and household ceramics. This heat can also be used for dryers if additional heat is needed, for instance in brickworks, as shown in Figure 4.2.

Economics

The economic application is strongly dependent on the existing conditions and the ceramic sector. For economic reasons, cogeneration has limited use throughout Europe, e.g. for the manufacture of brick and roof tiles. Nevertheless, the technique should be taken into consideration above all when designing a new plant.

A less expensive alternative to the utilisation of the excess heat described above is the direct introduction of heat into the dryer (see Section 4.1.2).

Driving force for implementation

Implementation of energy efficient production technology.

Example plants and reference literature

[4, UBA, 2001], [17, Burkart, 2004], [23, TWG Ceramics, 2005], [30, TWG Ceramics, 2005]

4.1.4 Substitution of heavy fuel oil and solid fuels by low emission fuels

Description and achieved environmental benefits

The switch of the firing process from heavy fuel oil (HFO) or solid fuels to gaseous fuels (natural gas, liquefied petroleum gas (LPG) and also liquefied natural gas (LNG)) leads to an improved firing efficiency and the virtual elimination of soot emissions in many processes. Solid fuels usually produce fine ash, so the reduction in particulate emissions when burning gas can, in some cases, obviate the need for expensive and energy consuming dust removal processes. Gas burners lend themselves to sophisticated automatic control systems, leading to fuel savings and reduced wastage of fired ware, hence reduced specific energy consumption. The use of fuel oil EL instead of HFO or solid fuels can also reduce soot emissions from firing processes.

Using natural gas, LPG, LNG or fuel oil EL instead of HFO or solid fuels leads to a reduction in energy linked SO₂ emissions because of the lower sulphur content (see Table 3.3). Also natural gas, LPG and LNG have higher hydrogen/carbon ratios than fuel oils or solid fuels, so they produce less carbon dioxide (approx. 25 % less CO₂ in the case of natural gas) for an equivalent heat output.

Alternative/secondary fuels of organic origin, e.g. meat and bone meal or biofuels, and of non-organic origin, e.g. waste oil, solvents, as for instance used in the manufacture of expanded clay aggregates (see Section 2.3.4.2.2), reduce the amount of primary fossil fuels and the related CO₂ emissions.

Additionally, the use of low emission fuels can involve other energy efficient technologies – for example cogeneration with gas turbines – into the manufacturing process. Other savings in (electrical) energy can also be achieved due to the fact that some liquid fuels (in particular HFO) have to be warmed to be pumpable.

Cross-media effects

Additional safety aspects – especially explosion risks – have to be taken into consideration, in particular regarding LPG and LNG.

Operational data

This depends on the particular individual case related measure/task.

Applicability

In principle, a fuel switch can be applied in all ceramic sectors, but it should be noted, that the nature of the fuel can also affect the aesthetic features of the end-product. Thus certain tints, which are very desirable in the marketplace, can only be achieved by (co)incinerating coal or coal dust in kilns. For instance, certain types of special coloured facing bricks cannot be manufactured by burning natural gas alone, but coal dust has to be injected additionally for firing the kiln (Hoffmann kilns are used for these purposes). So, depending on the product type manufactured, a fuel switch is not always possible.

In the manufacturing process of expanded clay aggregates, most of the channelled dust is recycled, which reduces the impact of a fuel switch on ash production.

Economics

The change of HFO or solid fuels to low emission fuels might involve considerable investment costs, especially if a natural gas supply to the factory is not available. In this context, not only the fuel costs, but also the additional transport costs for LPG, LNG and fuel oil EL have to be taken into account.

Driving force for implementation

- legal requirements
- less fluctuation in product quality
- reduction of CO₂ emissions.

Example plants and reference literature

[1, BMLFUW, 2003], [2, VITO, 2003], [3, CERAME-UNIE, 2003], [23, TWG Ceramics, 2005], [26, UBA, 2005], [30, TWG Ceramics, 2005], [32, TWG Ceramics, 2006]

4.1.5 Modification of ceramic bodies

Description and achieved environmental benefits

A sophisticated design of body composition can reduce necessary drying and firing times and so stimulates the use of low volume, rapid firing kilns such as roller hearth and moving bat types. Therefore, alterations to body composition can assist drying and firing, e.g. in the wall and floor tile and vitreous clay pipe sectors. This can result in reduced energy consumption in these areas. A similar approach is being researched for thicker walled ceramic products.

Pore-forming additives are primarily used to decrease thermal conductivity of clay blocks by creating micropores. Thus, the thermal mass of the clay blocks is reduced, and as a second advantage of the use of pore-forming additives, less energy for the firing is required.

The redesigning of ceramic ware may also reduce the mass – e.g. thinner tiles, multi-perforated bricks, thinner walled blocks or pipes. Where technically feasible, these changes can reduce energy consumption and emissions.

A reduction in the mixing water content required helps to save drying energy. The amount of mixing water needed is mainly dependent on the clay mineral composition and also on the granulometry. Water-saving additives consist of humid products with inorganic sequestering or complexing agents. They allow a reduction of the interfacial surface tension of the mixing water and an immobilisation of troublesome, free cations. The mixing water requirement in the raw material preparation process is reduced and an equal or even better plasticity is achieved. Additionally, the energy requirement of the drying process is minimised.

Automatically adjusting the mixing of water according to the required material plasticity and using water vapour to a certain extent instead of water for mixing, leads to a reduction of water (approx. 3 %), thermal energy (approx. 90 kWh/t product) and electricity (approx. 1.5 kWh/t product).

In any case, the addition of steam in the extrusion part facilitates the exit of the extruded clay and the exact humidity content needed for the clay can be achieved.

A significant reduction in the firing temperature and shortening of the residence time are achieved by the admixture of extremely effective sintering aids, such as earth alkali and high alkali additives, and of glass-forming agents. However, the use of such additives is only possible in some special cases, not for all ceramic products. Reductions in the final firing temperature of up to 50 K are possible. In order to avoid production breakdowns and a decline in quality, preliminary tests should normally be carried out before their use on large industrial scales.

Cross-media effects

The use of organic pore-forming agents may result in increased emissions of organic substances and CO to the air. The use of sintering aids increases emissions of CO₂ due to the high content of alkali carbonates.

Operational data

This depends on the particular individual case related measure/task.

Applicability and economics

The utilisation of sintering aids and energy containing pore-forming additives saves energy especially in brick manufacture. As already described above, the utilisation of energy containing secondary raw materials, such as sawdust, polystyrene (styropor) or paper binding agents, is possible in the manufacture of clay blocks. These pore-forming agents can provide up to 25 % of the total energy in the form of secondary energy in backing brick production. The use of pore-forming agents in facing brick production is exceptional because of their effect on the technical properties of bricks (e.g. colour, density).

However, in general, the shape and composition of the products are highly dependent on market requirements and therefore the modification of ceramic bodies is only possible to a limited extent and certainly not for all ceramic products.

Driving force for implementation

- higher product output
- better product quality.

Example plants and reference literature

JUWOE POROTON-Werke Ernst Jungk & Sohn GmbH, Germany, brickwork [4, UBA, 2001] [1, BMLFUW, 2003], [3, CERAME-UNIE, 2003], [23, TWG Ceramics, 2005], [30, TWG Ceramics, 2005]

4.2 Emissions of dust (particulate matter)

In this section, techniques and measures to prevent diffuse (mainly Sections 4.2.1 and 4.2.2) and channelled (mainly Section 4.2.3) emissions are described. In this context, useful information can also be found in the BREF on Emissions from Storage and in the BREF on Common Waste Water and Waste Gas Treatment/Management Systems in the Chemical Sector.

4.2.1 Measures for dusty operations

Description

Several different measures are presented here, which can be applied individually or in combination:

- enclosure of dusty operations, such as grinding, screening and mixing
- the use of covered and vented trough or pan mixers
- filtration of air displaced whilst charging mixers or dosing equipment
- storage silos with adequate capacity, level indicators with cut out switches and with filters to deal with dust-bearing air displaced during filling operations
- covered conveyor belts for potentially dusty raw materials
- a circulation process is favoured for pneumatic conveying systems
- material handling in closed systems maintained under negative pressure and de-dusting of the suction air
- reduction of air leakage and spillage points, completion of installation.

Achieved environmental benefits

- reduction of primarily diffuse dust emissions
- noise reduction is also possible by enclosing machinery.

Cross-media effects

- pneumatic conveying systems with air circulation may cause an increase of noise emissions and electrical energy consumption
- when maintenance is carried out, additional waste may occur.

Operational data

This depends on the particular individual case related measure/task. In any case regular maintenance and repair ensures that leaking off-gas pipes, storage silos and preparation units or damaged enclosures are repaired quickly.

Applicability

The measures can be carried out in all sectors of the ceramic industry, in old and new facilities, but when handling moist clays, not necessarily all of the measures mentioned above have to be carried out.

Economics

This depends on the particular individual case related measure/task. For old facilities the enclosure of installations may require a medium or long-term implementation plan.

Driving force for implementation

- legal requirements
- health and safety requirements for the workplace
- raw material savings.

Example plants and reference literature

[1, BMLFUW, 2003], [2, VITO, 2003], [3, CERAME-UNIE, 2003], [4, UBA, 2001], [23, TWG Ceramics, 2005], [26, UBA, 2005], [30, TWG Ceramics, 2005]

4.2.2 Measures for bulk storage areas

Description

In order to reduce primarily diffuse emissions at bulk storage locations of dusty mineral raw materials into the open air, such storage locations can be enclosed with screening, walling or an enclosure consisting of vertical greenery (artificial or natural wind barriers for open pile wind protection).

If dust emissions at discharge points of storage sites cannot be avoided, they can be reduced by matching the discharge height to the varying height of the heap, if possible automatically, or by reduction of the unloading velocity. Additionally, the locations can be kept wet – especially in dry areas – using spraying devices (if the point source of dust is locally limited, a water spray injection system can be installed) and can be cleaned with cleaning lorries.

To prevent the formation of diffuse dust during removal operations, vacuum systems can be used. New buildings can easily be equipped with stationary vacuum cleaning systems, while existing buildings are normally better fitted with mobile systems and flexible connections.

Achieved environmental benefits

Reduction of primarily diffuse dust emissions.

Cross-media effects

- the water consumption increases when keeping locations wet
- increase in energy consumption from the use of vacuum systems
- when maintenance is carried out, additional waste may occur.

Operational data

This depends on the particular individual case related measure/task.

Applicability

The measures can principally be carried out in all sectors of the ceramic industry, in old and new facilities, but when handling moist clays, not necessarily all of the measures mentioned above, have to be carried out. Also, sometimes dry raw materials are needed for mixing to achieve the desired properties, and therefore wetting can only be applied to a certain extent.

Economics

This depends on particular individual case related measure/task. In this context, see also Table 4.7.

Driving force for implementation

- legal requirements
- health and safety requirements for the workplace.

Example plants and reference literature

[2, VITO, 2003], [4, UBA, 2001], [17, Burkart, 2004], [23, TWG Ceramics, 2005], [26, UBA, 2005], [30, TWG Ceramics, 2005]

4.2.3 Separation/filter systems

This section describes some techniques which are aimed exclusively at dust removal. Additionally it can be noted, that most of the flue-gas cleaning techniques, which are described in Section 4.3.4, are not only suitable for the elimination of SO_x, HF and HCl, but also for eliminating dust.

4.2.3.1 Centrifugal separators

Description and achieved environmental benefits

In a centrifugal separator, the dust particles to be eliminated from an off-gas stream are forced out against the outer wall of the unit by centrifugal action and then eliminated through an aperture at the bottom of the unit. Centrifugal forces can be developed by directing the gas flow in a downward spiral motion through a cylindrical vessel (cyclonic separators) or by a rotating impeller fitted in the unit (mechanical centrifugal separators).

Cross-media effects

- the operation of centrifugal separators is a significant noise source
- the electricity consumption may increase if an impeller is applied
- when maintenance is carried out, additional waste may occur.

Operational data

Centrifugal separators perform more efficiently with higher pollutant loadings, provided that the device does not become blocked.

Applicability

The purification efficiency of centrifugal separators is generally too low to reduce any dust emissions to meet air pollution regulations in the ceramic industry. They are, therefore, only suitable as pre-separators and often used after spray drying, crushing and grinding operations.

Economics

Collection and recovery of separated dust leads to reduced raw material consumption.

Driving force for implementation

Raw material savings.

Example plants and reference literature

[1, BMLFUW, 2003], [2, VITO, 2003], [3, CERAME-UNIE, 2003], [23, TWG Ceramics, 2005]

4.2.3.2 Bag filters

Description and achieved environmental benefits

In a bag filter, the off-gas is passed through a filter bag, such that the dust particles are deposited on the filter surface in the form of a filter cake. Bag filter plants achieve high particulate retention, typically over 98 and up to 99 % depending on the particle size.

The following Figure 4.3 presents the schematic view of a bag filter with pressure pulse regeneration [4, UBA, 2001]. Regeneration is performed by a pressure pulse on the clean gas part of the bag filter.

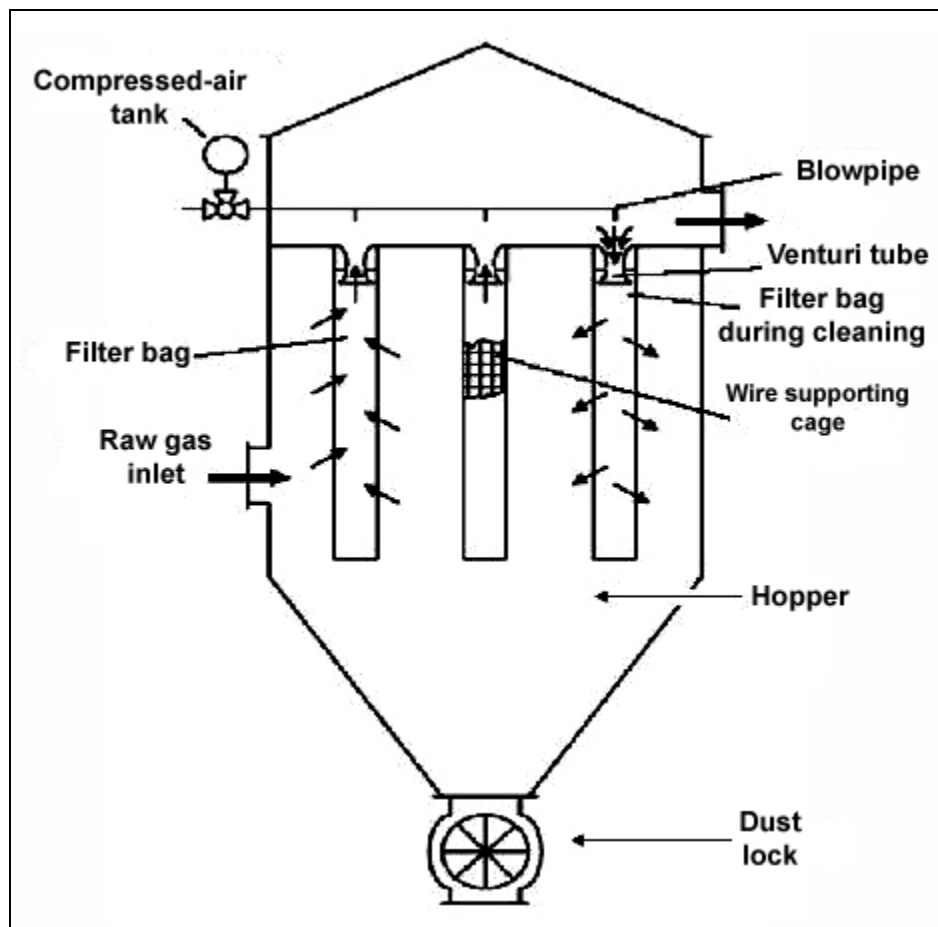

Figure 4.3: Schematic view of a bag filter with pressure pulse regeneration

Cross-media effects

- operation of bag filters, especially with pressure pulse regeneration, may cause noise emissions and they might also increase the electricity consumption due to their high pressure drop
- when maintenance is carried out, additional waste may occur.

Operational data and economics

Filter bags are available in a range of woven fabrics, some of which show good resistance to acids or alkalis. Modern synthetic fabrics include materials which tolerate quite high temperatures but bag filters cannot operate at temperatures which are too high. Examples of widely used filter fabrics are shown in the following Table 4.2, which indicates properties and relative prices [3, CERAME-UNIE, 2003]. In particular, if a bag filter is applied as part of a dry flue-gas cleaning device for the cleaning of kiln flue-gases (see Section 4.3.4.3), the filter and bag holders need to be corrosion-resistant, in case of condensation. Typical examples of data relating to the operation of fabric filters are listed in Table 4.3, and Figure 4.4 shows investment cost examples for filter plants excluding installation and filter bags [3, CERAME-UNIE, 2003], [23, TWG Ceramics, 2005].

Filter bag material	Temperature resistance (°C)	Price (EUR/m ²)
Cotton	80	<5
Polypropylene	100	5
Polyester	150	10 – 12
Nomex (m-Aramid)	220	25
PTFE (Teflon)	280	100 – 120

Table 4.2 Examples of temperature resistance and the price of filter bags

Raw gas dust loading	Up to 200 g/m ³
Clean gas dust loading	1 – 20 mg/m ³
Operating temperature	Up to 250 °C
Operating cost	0.03 – 0.1 EUR/t

Table 4.3: Examples of operating data for dust removal with fabric filters

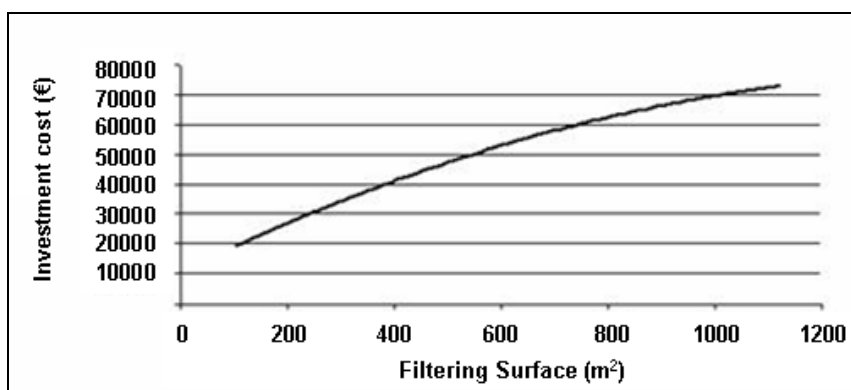

Figure 4.4: Investment cost examples as part of annual costs for filter plants excluding installation and filter bags

Self-cleaning bag filters should be large enough to run at a specific filtering surface load of less than 2 Nm³/(m² x minute), so that clean gas concentrations in the range of 1 – 20 mg/m³ can be reported [1, BMLFUW, 2003], [3, CERAME-UNIE, 2003], [23, TWG Ceramics, 2005]. Collection, recovery and re-use of separated dust leads to reduced raw material consumption.

Bag filters cannot operate at temperatures which are too high and – especially in the case of humid off-gases – at temperatures close to the dewpoint. This is because the filter can clog and will be difficult to dry out and clean again, due to reactions between water and CaO forming a hard crust. This will drastically increase maintenance and electricity costs and production time.

In principle, running costs of bag filters are strongly related to the amount of electricity needed to overcome the pressure drop, as mentioned above.

In this context, see also Table 4.7.

Applicability

Bag filters for dust removal from off-gases can, in principle, be applied in all sectors of the ceramic industry, especially for dusty operations (dedusting of silos for dry raw material storage, in dry raw materials preparation including spray drying, in dry shaping and in dry machining or grinding processes). Sometimes a combination with cyclone pre-filters is useful (see Section 4.2.3.1).

Driving force for implementation

- legal requirements
- possible raw material savings compared to other filter types (e.g. wet dust separator).

Example plants and reference literature

Tondach Gleinstaetten AG, brick and roof tile plant, Austria [1, BMLFUW, 2003], [2, VITO, 2003], [3, CERAME-UNIE, 2003], [4, UBA, 2001], [23, TWG Ceramics, 2005], [30, TWG Ceramics, 2005]

4.2.3.3 Sintered lamellar filtersDescription and achieved environmental benefits

The main elements of this filter are the rigid filter media, which are mounted as compact elements in the filter system. The filter elements consist of PTFE covered sintered polyethylene, which gives the filter element its hard structure and waterproof characteristics. The main advantages of these modern filter media are a very high dust cleaning efficiency from off-gases in combination with a low pressure drop as well as a high resistance against abrasive wear, resulting especially from rough ceramic particles.

The following figure presents the schematic view of such a rigid sintered lamellar filter, which is cleaned by a jet impulse self-cleaning system [4, UBA, 2001].

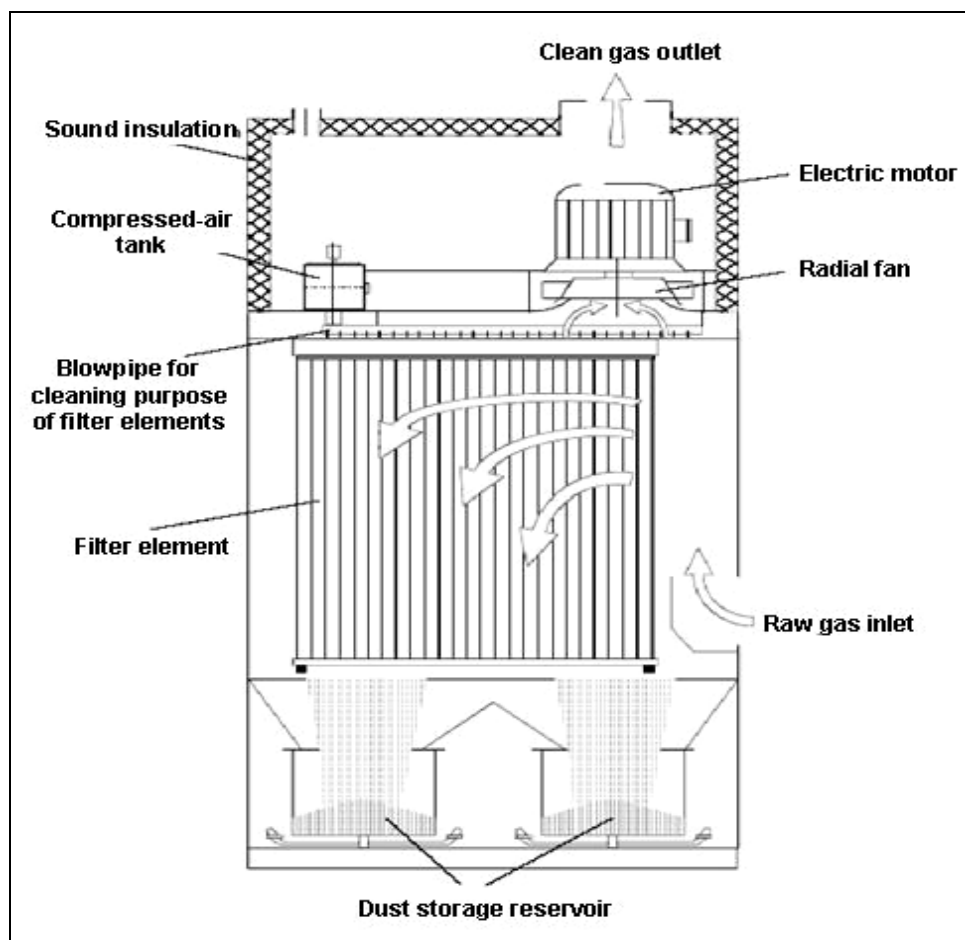

Figure 4.5: Schematic view of a rigid sintered lamellar filter

Cross-media effects

- operation of a sintered lamellar filter with jet impulse self-cleaning systems may cause noise emissions and additional energy consumption
- when maintenance is carried out, additional waste may occur.

Operational data

With these filter elements, cleaning efficiencies of up to 99.99 per cent with clean gas concentrations of $<1 \text{ mg/m}^3$ are achievable, so it is possible to feed the clean gas back to the workplace [4, UBA, 2001].

Applicability

The utilisation of sintered lamellar filters permits the separation of wet dust arising, for example, in spray glazing. This filter system makes a direct feeding back of glazing particles possible, separated from the off-gas of the spraying cabin. An upstream quiescent zone guarantees that the dust in the system is relatively dry. In an ideal case, the separated glaze particles arise as trickling powder in the filter system.

Economics

Usually the investment and operational costs of sintered lamellar filters are considerably higher than the costs for bag filters, however the possibility of feeding back the cleaned off-gas into the workplace area allows saving energy costs which would occur, if high volume flows of fresh air would have to be heated up to provide suitable workplace temperatures.

Driving force for implementation

- legal requirements
- health and safety requirements for the workplace
- raw material savings
- energy savings.

Example plants and reference literature

Oesterreichische Sanitaer-, Keramik- und Porzellan-Industrie AG, sanitaryware plant, Austria [1, BMLFUW, 2003], [4, UBA, 2001], [32, TWG Ceramics, 2006]

4.2.3.4 Wet dust separators

Description and achieved environmental benefits

With wet dust separators, dust is eliminated from off-gas streams by bringing the gas flow into close contact with a scrubbing liquid (usually water), so that the dust particles are retained in the liquid and can be rinsed away. Wet dust separators can be divided into various types according to their design and working principles (for instance venturi type).

Cross-media effects

With the wet removal technique, pollutants are transferred from air to water so a second installation for cleaning the wet waste product (suspension) is essential, and therefore additional energy consumption is also possible.

Operational data

Achievable clean gas concentrations in the range of 20 – 50 mg/m³ are reported [1, BMLFUW, 2003], [4, UBA, 2001]. In this context, see also Table 3.33.

Applicability

Wet dust separators are especially suitable for reducing humid or wet dust emissions in particular from spray drying processes if they are used in combination with cyclones. They are especially beneficial if the rinsing water can be re-used.

Economics

Regarding operating costs, scrubbing liquid and process waste water cleaning has to be taken into consideration. As a rule, smaller units controlling a low concentration off-gas stream will be much more expensive (per unit flowrate) than a large unit cleaning high pollutant load flow.

Driving force for implementation

Legal requirements.

Example plants and reference literature

Oesterreichische Sanitaer-, Keramik- und Porzellan-Industrie AG, sanitaryware plant, Austria [1, BMLFUW, 2003], [2, VITO, 2003], [4, UBA, 2001], [10, Navarro, 1998], [17, Burkart, 2004], [20, CERAME-UNIE, 2004], [23, TWG Ceramics, 2005], [32, TWG Ceramics, 2006]

4.2.3.5 Electrostatic precipitators (ESP)Description and achieved environmental benefits

In an electrostatic precipitator, the flue-gases are passed through a chamber with two electrodes. A high voltage (up to 100 kV) is applied to the first electrode, which ionises the flue-gases. The ions generated adhere to the dust particles in the flue-gases, and as a result these particles become electrically charged. Electrostatic forces repel the charged dust particles from the first electrode and attract them to the second, on which they are deposited. So the dust particles are removed from the flue-gas stream.

Cross-media effects

- explosion risks arise, particularly if dry ESP systems are applied
- the energy consumption increases due to the operation of the ESP (but a lower pressure drop compared to other filter systems may lead to lower electrical energy consumption of flue-gas fans)
- when maintenance is carried out, additional waste may occur.

Operational data and economics

The following Table 4.5 lists typical operating and cost data for electrostatic precipitators [3, CERAME-UNIE, 2003], [23, TWG Ceramics, 2005], [26, UBA, 2005], [28, Schorcht, 2005].

Gas volume	Up to 100000 m ³ /h
Gas velocity	0.5 – 3 m/s
Raw gas dust loading	Up to 100 g/m ³
Clean gas dust loading	5 – 50 mg/m ³
Operating temperature	Up to 450 °C
Voltage	10 – 100 kV
Energy consumption	0.05 – 2 kWh/1000 m ³
Investment cost	EUR 1 – 3 million
Operating cost	0.1 – 0.2 EUR/t

Table 4.4: Operating and cost data for electrostatic precipitators

In this context, see also Table 4.7.

Relatively high maintenance costs have to be taken into consideration, when operating an electrostatic precipitator.

Achievable dust clean gas concentrations of less than 50 mg/m³ are reported from a manufacturing process of expanded clay aggregates in a rotary kiln, equipped with an electrostatic precipitator (see Section 3.3.4.1) [17, Burkart, 2004].

Applicability

Electrostatic precipitators are used in the ceramic industry primarily in the manufacture of expanded clay aggregates behind rotary kilns and dry grinding units, where high volume flows have to be treated at high temperatures with relatively high operating reliability.

Driving force for implementation

- legal requirements
- raw material savings.

Example plants and reference literature

Plant Hallerndorf-Pautzfeld, Germany (manufacture of expanded clay aggregates), Plant Lamstedt, Germany (manufacture of expanded clay aggregates) [26, UBA, 2005], [2, VITO, 2003], [3, CERAME-UNIE, 2003], [17, Burkart, 2004], [23, TWG Ceramics, 2005], [28, Schorcht, 2005], [30, TWG Ceramics, 2005]

4.3 Gaseous compounds

4.3.1 Reducing the input of pollutant precursors

Description and achieved environmental benefits

Oxides of sulphur

- the use of low sulphur raw materials and additives can significantly reduce SO_x emissions
- in the case of sulphur rich raw materials, the addition of low sulphur body additives (e.g. sand) or low sulphur clay reduces SO_x emissions by a dilution effect
- the use of low sulphur fuels, such as natural gas or LPG, leads to significantly reduced SO_x emissions.

Oxides of nitrogen

- minimisation of nitrogen compounds in raw materials and additives can reduce NO_x emissions.

Inorganic chlorine compounds

- the use of low chlorine raw materials and additives can significantly reduce chlorine emissions.

Inorganic fluorine compounds

- the use of low fluorine raw materials and additives can significantly reduce fluoride emissions
- in the case of fluorine rich materials, the addition of low fluoride body additives (e.g. sand) or low fluoride clay reduces fluoride emissions by a dilution effect.

Volatile organic compounds (VOCs)

Minimisation of organic compounds in raw materials, additives, binders, etc. can reduce VOC emissions. For instance, organic additives such as sawdust and polystyrene are added to the raw material mixture mainly in the manufacture of porous products. However, these organic additives give rise to VOC emissions (in this context see Table 3.4 regarding raw gas values from brick manufacturing processes, using various pore-forming agents). The generation of VOC emissions can, in principle, be avoided by switching to inorganic pore-forming additives, e.g. perlite (a glassy volcanic material containing 3 to 4 % water. On heating (800 to 1100 °C) the material expands, due to the steam bubbles formed inside, to between 15 and 20 times its original volume).

Cross-media effects

Minimisation of organic compounds in raw materials may increase energy consumption for the firing process.

Operational data and applicability

Reducing the input of pollutant precursors is a preferred measure to reduce pollutants in the flue-gases of a kiln, because the problem is solved at source, but owing to specific constraints, in reality the applicability is sometimes difficult. Therefore, the use of raw materials and additives, which have low contents of pollutant precursors, can, in principle, be applied to all sectors of the ceramic industry. However their single case related availability and possible product quality problems (e.g. regarding colour compressive strength and frost resistance) always have to be taken into consideration and careful testing of the raw material mixtures always has to be carried out.

For instance, inorganic pore-forming additives give rise to technical difficulties, because these substances have a tendency to expand too suddenly and too sharply, so that the pore-forming becomes difficult to control and product quality drops. As a result of this, a switch from organic to inorganic pore-forming additives is probably not feasible in practice. There is one brick works known in Flanders which does use perlite as an additive. However, this involves a form of perlite already expanded and ground, used to make rich Boom clay leaner rather than as a pore-forming agent.

For expanded clay manufacturing, the reduction of VOCs is not possible because VOCs are used for pore forming.

Also, the pollutant content of the raw materials is a significant but not always the determinant parameter for the pollutant emissions during firing, because these emissions depend on several criteria, for instance operative parameters of the firing process. Thus, a 50 % decrease in the pollutant content of the raw materials does not always determine the same reduction of the pollutant emission, as experience has also shown the correlation between the fluorine content of clay and the HF emission concentration.

Regarding the sulphur problems it has to be mentioned that the usual location of the pit near the plant limits the choice of low sulphur raw materials (see also 'Economics').

Economics

For a company that has a pit with high sulphur content, the use or admixing of low sulphur clay materials presupposes a supply of clay material extracted by others from elsewhere. This entails a substantial added cost, due on the one hand to the cost of additional transport (estimated in 1998 as EUR 0.05/tonne/km) and on the other to the increased cost of extraction (estimated in 1998 as EUR 2.5/tonne) which will have to be paid to a third party compared to the cost of clay from their own pit [2, VITO, 2003]. The minimisation of organic compounds in raw materials may also increase the costs because of possible higher transportation distances from external suppliers to the plant.

Measures involving the addition of low sulphur and/or body additives of clay containing calcium (see also Section 4.3.2) may involve substantial investment costs (up to EUR 850000), e.g. for additional storage capacity and for modification of the machinery used in the preparation of the raw materials, shaping and drying. They may also involve additional operational costs and extra material costs.

Driving force for implementation

- legal requirements
- avoidance of expensive end-of-pipe abatement techniques.

Example plants and reference literature

[2, VITO, 2003], [3, CERAME-UNIE, 2003], [4, UBA, 2001], [23, TWG Ceramics, 2005], [30, TWG Ceramics, 2005]

4.3.2 Addition of calcium rich additives

Description and achieved environmental benefits

The addition of fine limestone or chalk to ceramic bodies has a dilution effect, but the calcium rich additives also react at relatively low temperatures of between 700 and 850 °C with raw materials containing fluoride and chloride, and with sulphur oxides formed during firing from raw materials containing sulphur, to retain the fluorine, chlorine and sulphur within the fired body.

This chemical reaction serves to 'fix' fluoride by formation of stable calcium fluoride and can significantly reduce HF emissions.

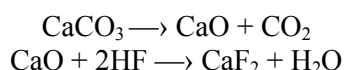

A similar reaction also serves to 'fix' chloride and SO_x within the ceramic body, as mentioned above, and can also significantly reduce HCl and SO_x emissions.

However, the concentration of HF, HCl and SO_x in flue-gases is not necessarily related to the level of CaO in the raw material, because experience shows that even fine carbonates or CaO present in the clay products during the firing process might have little or no effect on the emission levels of HF, HCl and SO₂/SO₃. This mainly occurs due to high firing temperatures inside the kiln, causing the CaSO₄, CaCl₂ and CaF₂ to decompose. At a temperature of about 850 °C the CaF₂ starts to decompose. At a high temperature (above 900 °C) the CaO will also react with silicates to form calcium silicates, reducing the amount of available CaO.

Cross-media effects

The addition of calcium rich additives may increase energy consumption for firing, this being due on the one hand to the occurrence of endothermic reactions in the kiln and on the other hand, to the longer firing times required. Also the addition of calcium carbonate rich additives increases the CO₂ emissions.

Operational data and applicability

Calcium rich additives can induce a decrease of 10 to 75 % in fluorine emissions (depending on the raw material and the peak firing temperature) but their addition may affect the quality of the end-product; therefore, this measure cannot be applied unlimitedly in practice [4, UBA, 2001].

The main application sector is the brick industry, if technical properties of the final product can be fulfilled; in the refractory industry this measure is not usual. Quality aspects affected by the addition of lime are as follows:

- colour: increasing the addition of lime causes a change in colour tending to lighter (more yellow) shades. Slight discolouration is permissible in the manufacture of bricks for interior walls, but such discolouration can give rise to sales problems in the manufacture of facing bricks and therefore it is not possible to utilise these additives in all brick masses. The addition of Fe_2O_3 may partially compensate for yellow discolouration
- the concentration of water soluble sulphates: this increases with increased quantities of added CaCO_3 . Water soluble sulphates are partly the cause of efflorescence problems on brickwork
- compression strength: adding calcium carbonate can have a slightly positive as well as a slightly negative effect on compression strength
- shrinkage behaviour: adding chalk has a relatively unpredictable effect on the shrinkage behaviour of the product during drying and firing
- water absorption: spontaneous water absorption increases with increasing quantities of added CaCO_3 , and as a result of which the saturation coefficient rises. This results in a reduction in frost resistance of the brick and an increased likelihood of efflorescence. These effects are more tolerable in bricks for interior walls than in facing bricks
- expanded clay aggregates are to have a maximum of 3 % CaO , otherwise the granule strength is significantly reduced and additionally above 5 %, expansion becomes poor due to excessive fluxing [2, VITO, 2003].

Economics

Increased CO_2 emissions, induced by utilisation of calcium carbonate rich additives, may increase costs due to legal requirements (e.g. emissions trading). Also, changes in shrinkage behaviour of ceramic products may affect mechanical processing during manufacture.

Measures involving the addition of low sulphur and/or body additives of clay containing calcium (see also Section 4.3.1) may involve substantial investment costs (up to EUR 850000), e.g. for additional storage capacity and for modification of the machinery used in the preparation of the raw materials, shaping and drying. They may also involve additional operational costs (extra material costs).

Driving force for implementation

- legal requirements
- avoidance of expensive end-of-pipe abatement techniques.

Example plants and reference literature

[2, VITO, 2003], [3, CERAME-UNIE, 2003], [4, UBA, 2001], [23, TWG Ceramics, 2005], [30, TWG Ceramics, 2005]

4.3.3 Process optimisation

4.3.3.1 Optimising the heating curve

Description, achieved environmental benefits and operational data

The rate of heating as well as the level of the firing temperature can affect SO_x and HF emissions:

- reducing the rate of heating in the lowest temperature range (up to 400 °C) promotes the resorption of HF with the formation of CaF₂, resulting in a decrease of HF emissions. A similar effect can apply to SO_x emissions. They are usually formed by the oxidation of pyrite, and/or the dissociation of calcium sulphate present in the ceramic body
- by increasing the rate of heating in the temperature range of between 400 °C and the firing temperature, the sintering temperature is reached more rapidly, and as a result, the release of emissions becomes limited by diffusion, and the emissions decrease
- the height of the firing temperature affects the decomposition of sulphates. The lower the firing temperature is, the less decomposition there is, hence the lower SO_x emissions there are. Reducing the firing temperature can be achieved by adding fluxes to the raw material mixture
- faster firing cycles generally result in reduced fluoride emissions. The characteristics of the raw material influence fluorine release, but for any given ceramic product the firing time above the temperature of 800 °C is crucial
- control of oxygen levels in firing processes maximises combustion efficiency.

The following figure shows the temperature ranges of a temperature curve example for the release of pollutants during the firing of bricks [4, UBA, 2001], [30, TWG Ceramics, 2005].

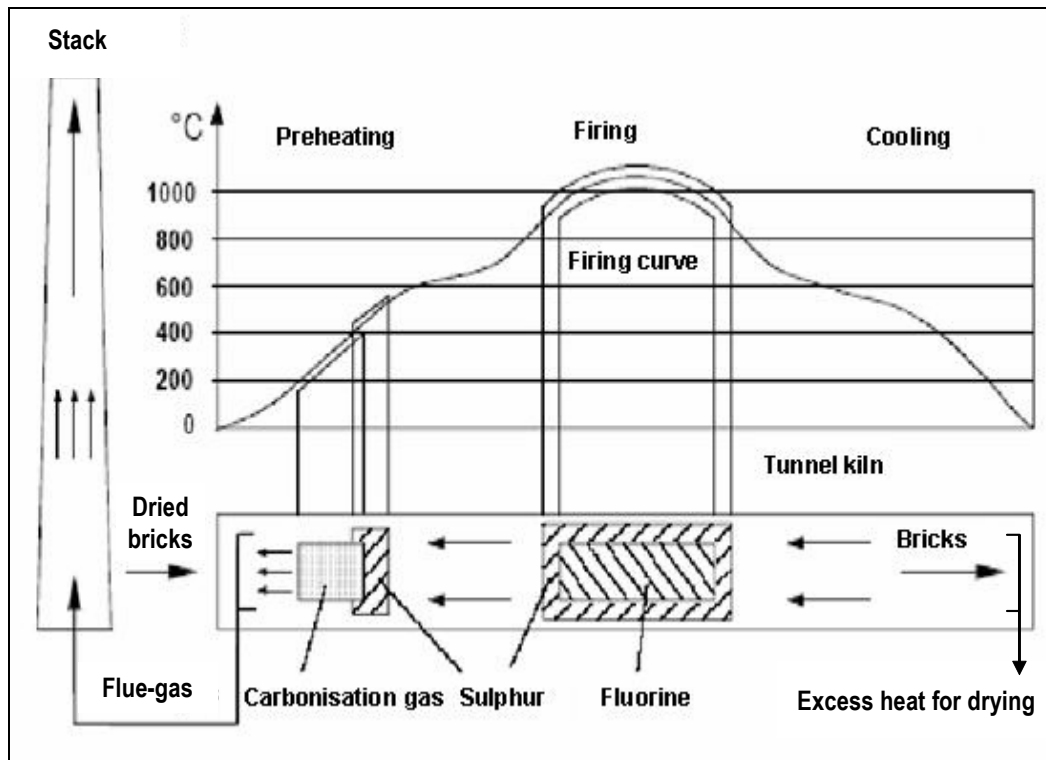

Figure 4.6: Temperature ranges of a temperature curve example for the release of pollutants during the firing of bricks

Cross-media effects

No issues.

Applicability and economics

Optimisation of the heating curve/process control can be applied in all sectors of the ceramic industry, but it should be noted that in practice, heating curves in the clay processing industry are optimised in line with product quality and energy consumption. Therefore, heating curves can only be changed if the technical properties of the final product allow this and additional costs must be taken into account when altering heating curves for emission reasons.

Driving force for implementation

- legal requirements
- avoidance of expensive end-of-pipe abatement techniques
- operation of kilns in an energy efficient way.

Example plants and reference literature

[2, VITO, 2003], [3, CERAME-UNIE, 2003], [4, UBA, 2001], [23, TWG Ceramics, 2005]

4.3.3.2 Reduction of water vapour levels in the kiln gases

Description, achieved environmental benefits and operational data

Reduction of water vapour levels in the kiln gases usually results in lower emission rates for fluoride, because the basic mechanism for the release of fluorine from clay minerals is pyrohydrolysis. This reaction occurs at temperatures of 800 °C and upwards.

Cross-media effects, applicability and economics

In laboratory tests, it was found that reducing the water content in the kiln atmosphere, did result in reduced emissions of HF as well as of SO_x. In practice, a reduction of the water content in the kiln atmosphere would be technically difficult to achieve, given that water is produced during the combustion of the fossil fuels used to heat the kiln. This production of water can be avoided only by heating the kiln either indirectly, for instance with gas-fired radiant-tube burners [5, InfoMil, 2003], or by electricity, but this would require a fundamental change in the design of the kiln and entail higher energy consumption.

In principle, all over Europe only the firing of kilns with fossil fuels is economically viable for the bricks and roof tiles, vitrified clay pipes, refractory products and expanded clay aggregates sectors. Therefore heating the kiln with electricity or indirectly is not really applicable in these sectors (electrical heating is only carried out for short runs of special products in the case of refractory products). In the wall and floor tiles, table- and ornamentalware, sanitaryware, technical ceramics and inorganic bonded abrasives sectors however, the reduction of water vapour levels in kiln gases by heating the kilns with electricity (in the manufacturing of some technical ceramics electrically heated kilns are used to a certain extent) or indirectly with radiant-tube burners [5, InfoMil, 2003] (shuttle kilns or small roller hearth kilns can, in principle, be equipped with these burners for smaller scale production), has a more realistic potential of application.

Driving force for implementation

- legal requirements
- avoidance of end-of-pipe abatement techniques.

Example plants and reference literature

[2, VITO, 2003], [3, CERAME-UNIE, 2003], [5, InfoMil, 2003], [23, TWG Ceramics, 2005]

4.3.3.3 Internal carbonisation gas combustion

Description and achieved environmental benefits

VOC emissions which occur in the heating area of the kiln as a result of decomposition and incomplete combustion of organic components in the raw material mixture (known as carbonisation gases), can be subsequently burned in the kiln, provided the kiln has been specially modified. Internal combustion can be achieved by directing the carbonisation gases from the heating zone of the kiln back to the firing zone, where they will be further burned as a result of the high temperature prevailing there. In order to achieve this, the kiln zone where the VOC emissions occur (known as the carbonisation zone) needs to be separated from the rest of the kiln. This can be achieved by installing one or more sliding doors in the kiln or with a special extraction system for the carbonisation gases. With this technique, not only VOC emissions, but also CO emissions are significantly reduced. The following figure shows a schematic view of internal carbonisation gas combustion [4, UBA, 2001], [30, TWG Ceramics, 2005].

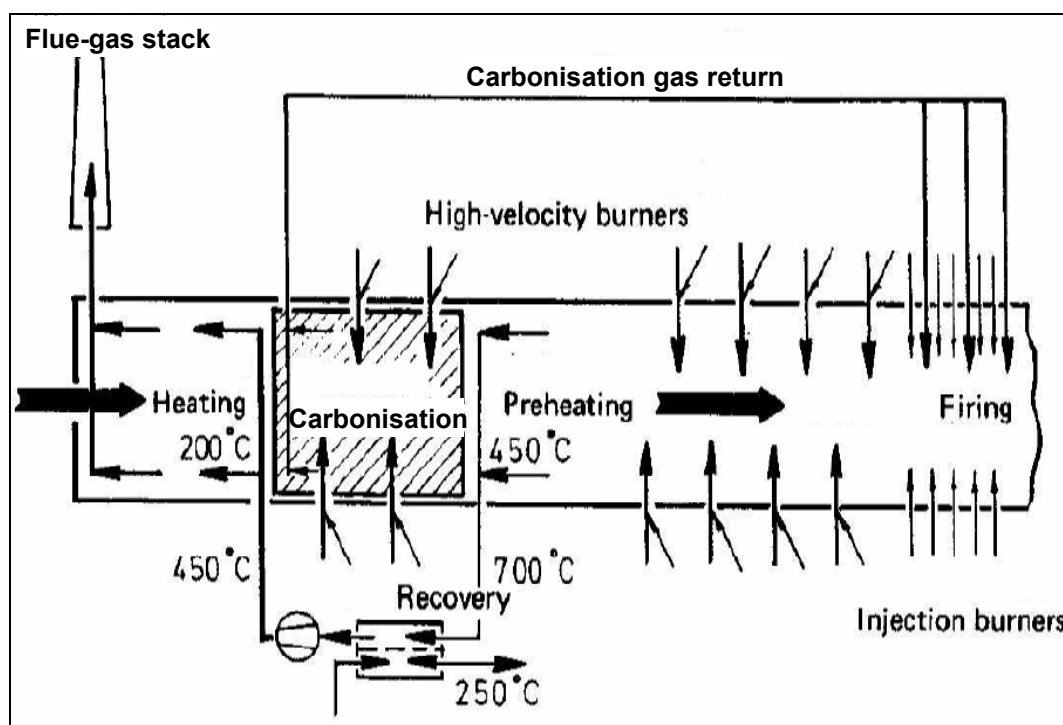

Figure 4.7: Schematic view of internal carbonisation gas combustion

Cross-media effects

Carbonisation gas combustion inside the kiln may increase overall energy consumption, especially if additional firing with (high velocity) burners has to be carried out to burn the carbonisation gases from the heating zone.

Operational data and applicability

Systems for internal combustion of carbonisation gases have already been in use for some time in Germany, particularly by a few dozen brickworks. These systems enable VOC emissions to be reduced significantly, but suffer from the practical disadvantage that they often interfere with the normal operation of the kiln, and as a result it becomes difficult to control. Doors seizing, for instance, is a known problem in systems which operate with sliding doors in the kiln. The interference of the thermal afterburning inside the kiln, when using a tunnel kiln as a simple counter flow heat exchanger, often leads to problems in the kiln operation mode or to higher operation expenditure. Probably for these reasons, external carbonisation gas afterburning systems have gained increasing favour, especially for new plants in recent years.

This technique is not applicable for the manufacture of expanded clay aggregates, as there is the problem that drying and firing take place together, which results in gases containing high concentrations of water.

By employing this technique, clean gas values for total-C of approximately 15 mg total-C/m³ can be obtained, if the raw gas values are 250 mg total-C/m³ [4, UBA, 2001].

Economics

Internal carbonisation gas combustion is, because of the complicated firing and control techniques, a relatively expensive system regarding maintenance cost.

In this context, see Table 4.7.

Driving force for implementation

- legal requirements
- avoidance of end-of-pipe abatement techniques.

Example plants and reference literature

[2, VITO, 2003], [3, CERAME-UNIE, 2003], [4, UBA, 2001], [23, TWG Ceramics, 2005]

4.3.3.4 Low-NO_x burnersDescription, achieved environmental benefits and operational data

Emissions of nitrogen oxides arise from firing ceramic products, e.g. refractory products at temperatures of above 1300 °C. These NO_x emissions can be minimised by the operation of special low-NO_x burners. These burners are useful for reducing the flame temperature and thus reducing thermal and (to some extent) fuel derived NO_x. The NO_x reduction is achieved by supplying rinsing air for lowering the flame temperature or pulsed operation of the burners.

Cross-media effects

No issues.

Applicability

The applicability and efficiency of low-NO_x burners depend on several factors such as the ultimate firing temperature. Lack of efficiency in some cases at temperatures of above 1400 °C is reported. In this context, useful additional information can be found in the BREF on Glass Manufacturing, where low-NO_x burners are also mentioned. Also due to product quality requirements of the final product, the use of low-NO_x burners may be restricted [23, TWG Ceramics, 2005], [30, TWG Ceramics, 2005].

Driving force for implementation

Legal requirements.

Example plants and reference literature

[1, BMLFUW, 2003], [3, CERAME-UNIE, 2003], [4, UBA, 2001], [23, TWG Ceramics, 2005]

4.3.4 Sorption plants (adsorbers, absorbers)

In this context, useful information can also be found in the BREF on Common Waste Water and Waste Gas Treatment/Management Systems in the Chemical Sector.

4.3.4.1 Cascade-type packed bed adsorbers

Description and achieved environmental benefits

In a cascade-type packed bed adsorber, the reaction between the adsorbent, usually calcium carbonate (CaCO_3 , limestone) and the pollutants (mainly HF, SO_x and HCl) in the flue-gas takes place in a chamber, in which the adsorbent sinks by gravity and through which the flue-gases are passed in counter- or crossflow. In order to achieve sufficient reaction time and contact area, baffles are provided in this chamber. These baffles retard the downward velocity of the adsorbent and ensure effective circulation and distribution of flue-gases in the unit. The spent calcium carbonate is collected at the bottom of the installation. These adsorbers can deal with gases at temperatures of up to 500°C without prior cooling and, therefore, are very efficient in reducing HF, SO_x and HCl emissions from kiln flue-gases. An illustration of a crossflow adsorber is shown in the following figure [4, UBA, 2001].

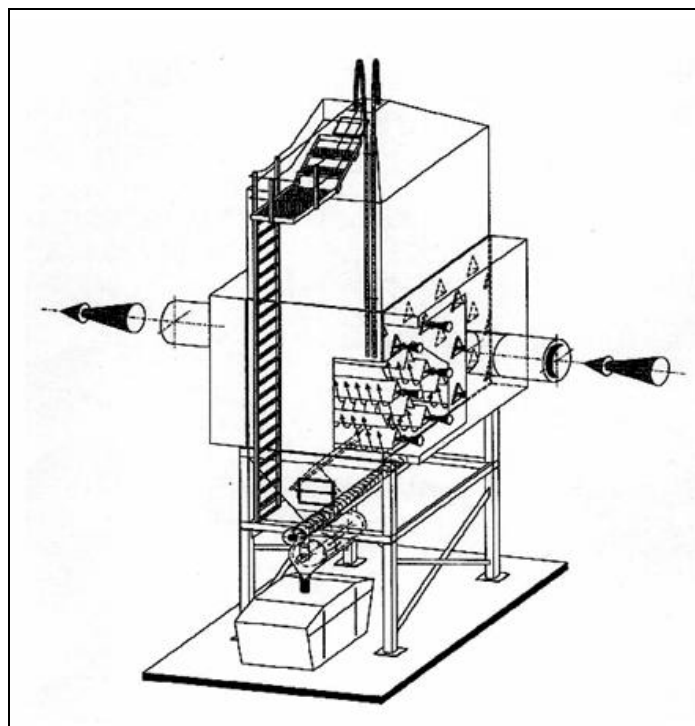

Figure 4.8: Illustration of a crossflow cascade adsorber

Calcium carbonate is used in the form of granules with a usual grain size of 4 – 6 mm, which must meet certain specifications with regard to size, composition and porosity in order to obtain maximum purification efficiency. In addition to ordinary calcium carbonate, modified types of calcium carbonate, composed of calcium carbonate/calcium hydroxide ($\text{CaCO}_3/\text{Ca}(\text{OH})_2$) mixtures, can be used as adsorbents. Due to their increased porosity and higher calcium hydroxide content, these have a greater affinity for acid gases.

Because the adsorption of HF, SO_x and HCl mainly takes place on the outside of the calcium carbonate granules, the adsorption efficiency of the granules is quite low. In order to increase the adsorption efficiency when using unmodified calcium carbonate, a peeling technique can be used. In this, the softer outer coating of the spent granules, which consists of calcium fluoride, calcium sulphite, calcium sulphate or calcium chloride, is removed mechanically. The remaining granule can be re-used as an adsorbent provided its size is large enough so that less waste (in the form of peeled off saturated limestone) occurs.

In case of the modified granules, a greater affinity for acid gases is achieved by improved surface qualities; therefore they cannot be peeled in order to be re-used, as is possible with unmodified calcium carbonate.

The following figure presents a process diagram of a cascade-type packed bed adsorber with peeling drum. The peeled sorption agent is fed back to the storage silo automatically. The quantity of waste is reduced by up to 50 per cent by this measure [4, UBA, 2001].

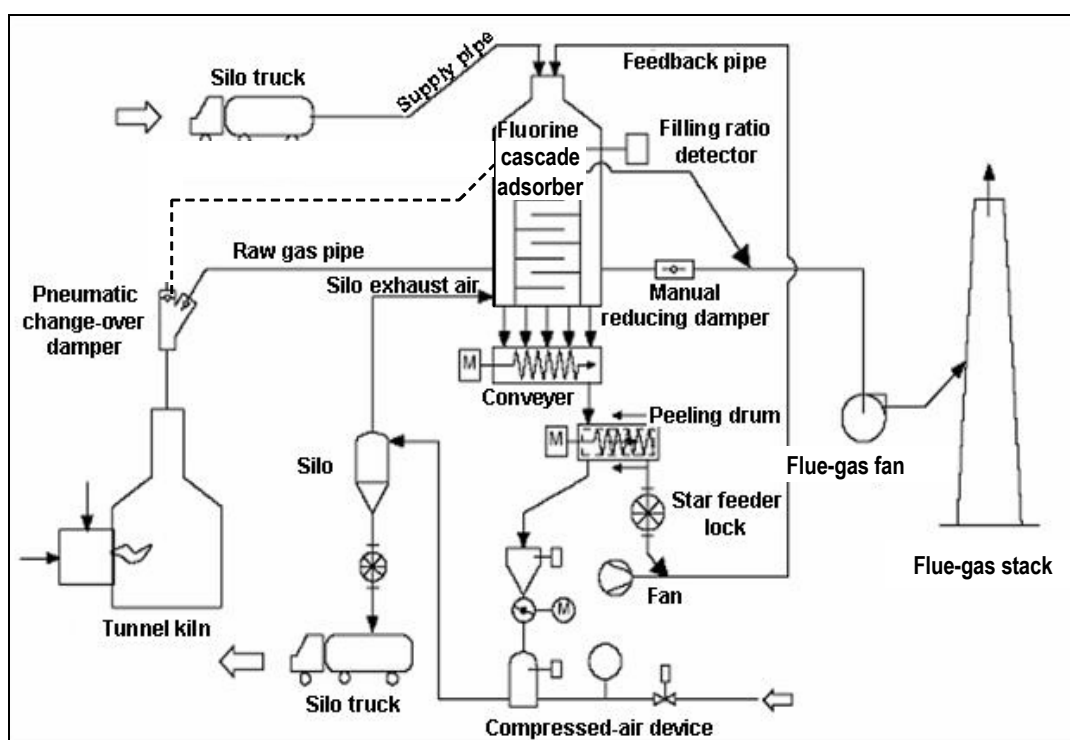

Figure 4.9: Process diagram of a cascade-type packed bed adsorber with peeling drum

The limestone granulate, saturated with pollutants, is delivered to the peeling drum by a screw conveyor. The outer layer, saturated with the pollutants, is removed by rubbing and taken out together with the small granulate with a particle diameter <2.5 mm. This contaminated material is discharged by silo trucks. The surface of the remaining granulate with a particle diameter >2.5 mm becomes reactive again. The recycled granulate is fed back to the storage silo of the adsorber by a star feeder lock and a feedback pipe. The adsorber, the peeling drum and the feedback pipe are a closed system. The peeling and the feeding back take place automatically and continuously.

Cross-media effects

- high consumption of adsorbents
- large amount of waste (due to the relatively high excess dosage of adsorbent)
- calcium carbonate granules react with the acidic components of the flue-gas to develop CO₂
- increased energy consumption due to the operation of the adsorber (in particular to overcome the pressure drop)
- increased dust emissions as result of the increase in the dust load arising from the calcium carbonate granules are possible, especially if peeling drums are used
- possible noise emissions.

Operational data

Unmodified calcium carbonate granules, preferably softer types of calcium carbonate, are especially suited for removing HF and SO₃. For these compounds, the granules achieve purification efficiencies in excess of 90 % (up to 99 %) and 80 %, respectively. Ordinary calcium carbonate is, however, not very suitable for the removal of SO₂ as SO₂ is less reactive compared to HF and SO₃; the purification efficiency is in the order of magnitude of 20 %. For HCl, the purification efficiency of unmodified calcium carbonate is approximately 50 % [2, VITO, 2003], [4, UBA, 2001], [30, TWG Ceramics, 2005].

Modified calcium carbonate is more suitable for SO₂ removal and also yields slightly better efficiencies for HF and SO₃ removal. With modified calcium carbonate, purification efficiencies of up to 99 % for HF, up to 85 % for SO₃, 30 up to 85 % for SO₂ for a raw gas concentration of up to 1500 mg SO₂/m³ and an efficiency of more than 50 % for HCl are achievable. The cleaning efficiency of these systems is up to 100 % for the retention of suspended particulates (see also Section 4.3.6) [4, UBA, 2001], [30, TWG Ceramics, 2005].

Flue-gas with a content of approximately 2500 mg SO₂/m³ can, under certain circumstances – for example with four adsorbers (packed bed counterflow type with modified calcium carbonate) arranged downstream of each other – be sufficiently filtered to achieve clean gas values of below 500 mg SO₂/m³. Also a purification efficiency of the highly loaded raw gas of 85 % for SO₂ can be achieved [4, UBA, 2001], whereas with only one adsorber, the purification efficiency for SO₂ drops down to approximately 30 %. [2, VITO, 2003], [23, TWG Ceramics, 2005].

In this context, see also Table 3.2 regarding the distribution of released chloride, Table 3.6, Table 3.7, Table 3.8 and Table 3.9 regarding emissions from brick and roof tile manufacturing processes and Table 3.43 regarding emissions from a sanitaryware manufacturing process, applying packed bed adsorber systems [2, VITO, 2003].

Applicability

This technique can be applied in several sectors of the ceramic industry, but the amount of space taken up by the system and a lack of flexibility with regard to controls and to the use of other adsorbents should be noted. Other conditions such as raw gas concentrations of HF and SO_x, clay product range, kiln operation, kiln size, kiln production rate, required top burning temperature, flue-gas amount and temperature, total resulting dust load from the adsorber, requirement for a dust filter, possibility of re-use, recycling or deposit of large waste amounts from adsorbers, availability of suitable limestone pellets, increase in electricity demand and total environmental impact must also be taken into consideration.

Economics

In this context, see Table 4.7.

Smaller quantities of peeled off saturated limestone can be added to the manufacture of clay blocks and facing bricks, but it must be taken into account, that the calcium sulphate content of the saturated limestone may lead to efflorescence on the bricks. Utilisation of the saturated limestone in the cement, concrete and asphalt industry is also possible. If no re-use is possible, additional disposal costs also have to be considered.

Driving force for implementation

Legal requirements.

Example plants and reference literature

Wienerberger Ziegelindustrie AG, facing brick plant, Rotenturm, Austria [1, BMLFUW, 2003], Erlus Baustoffwerke AG, roof tiles plant, Neufahrn, Germany [4, UBA, 2001], [2, VITO, 2003], [3, CERAME-UNIE, 2003], [23, TWG Ceramics, 2005]

4.3.4.2 Module adsorber systems

Description and achieved environmental benefits

A process, predominately employed in the separation of gaseous inorganic fluorine compounds, is dry sorption using honeycomb modules made of calcium hydroxide in so-called module adsorber systems. In this process, the flue-gas passes through a simple steel reactor with no moving parts. The reactor houses several layers of honeycomb adsorber modules filled with slaked lime (calcium hydroxide) that chemically converts the HF content of the flue-gases to calcium fluoride (CaF_2) as it passes through the modules. The lifetime of the modules is influenced by the operation time of the plant, the flue-gas volume flow and the fluorine concentration in the raw gas. The modules are allocated in support racks to reduce the module-changing time and to facilitate the handling. Saturated modules are replaced by new ones.

The following figure shows the schematic view of the dry sorption unit using honeycomb modules made of $\text{Ca}(\text{OH})_2$ [4, UBA, 2001].

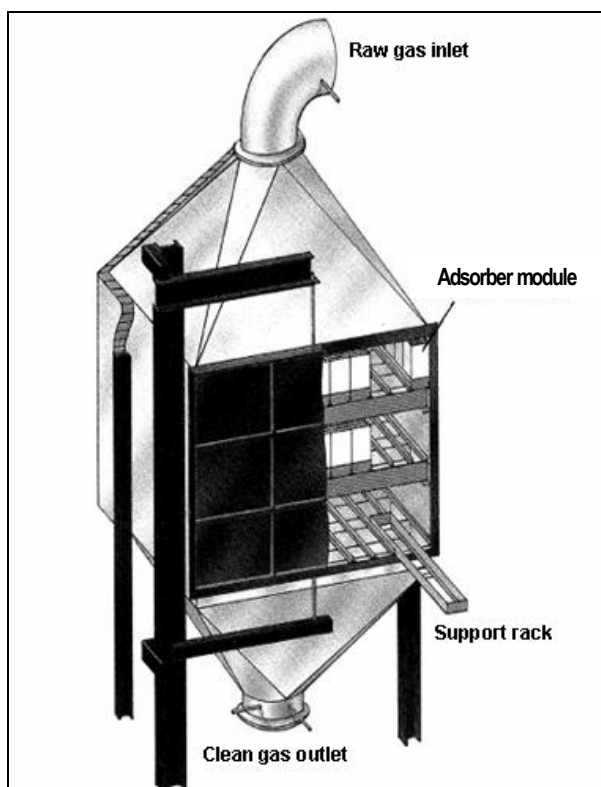

Figure 4.10: Schematic view of a honeycomb module adsorber system

Cross-media effects

- relatively high consumption of adsorbents
- large amount of waste (saturated modules have to be disposed of)
- increased energy consumption possible, due to the operation of the adsorber (in particular to overcome the pressure drop in the case of flue-gases with higher dust loads).

Operational data and applicability

This system is technically simple and robust, because it is built without moving parts and it has a low pressure drop. It is particularly efficient for cleaning lower flue-gas flowrates (<18000 m³/h) and when concentrations of inorganic compounds other than HF (SO₂, SO₃, HCl) are low. For this reason, this type of system is applied mainly in the wall and floor tiles, table- and ornamentalware, sanitaryware and technical ceramics industries. Additionally, the capillaries tend to clog if there are higher dust concentrations and, therefore, the system is not really suitable for dedusting purposes.

In this context see Table 3.41, where raw and clean gas concentrations from a sanitaryware manufacturing process are listed and where a honeycomb adsorber module system for flue-gas cleaning is applied.

Economics

In this context, see Table 4.7. Additionally to the price of the new adsorber modules, the price for disposal of the saturated modules has to be taken into account, because re-use is not possible.

Driving force for implementation

Legal requirements.

Example plants and reference literature

[1, BMLFUW, 2003], [4, UBA, 2001], [23, TWG Ceramics, 2005]

4.3.4.3 Dry flue-gas cleaning with a filter (bag filter or electrostatic precipitator)

Description and achieved environmental benefits

With this type of flue-gas cleaning, the adsorbent is blown into the flue-gas stream in dry form. Acid components (sulphur oxides and inorganic chlorine and fluorine compounds) are adsorbed in a reactor or a reactor zone, which can be the flue-gas duct between the kiln and the filter with a certain minimum length, to ensure the necessary contact time. The filter behind the reactor (zone) removes the produced neutralisation salts and the excess adsorbent from the flue-gas stream. A bag filter is mainly used for this purpose because it generates good contact between the adsorbent and the gaseous contaminants. The fabric of the filter bags must be resistant to acid and alkaline conditions, and is also defined by the temperature of the gases to be treated (see Table 4.2). The following figure shows a schematic view of dry flue-gas cleaning with a bag filter [10, Navarro, 1998], [23, TWG Ceramics, 2005].

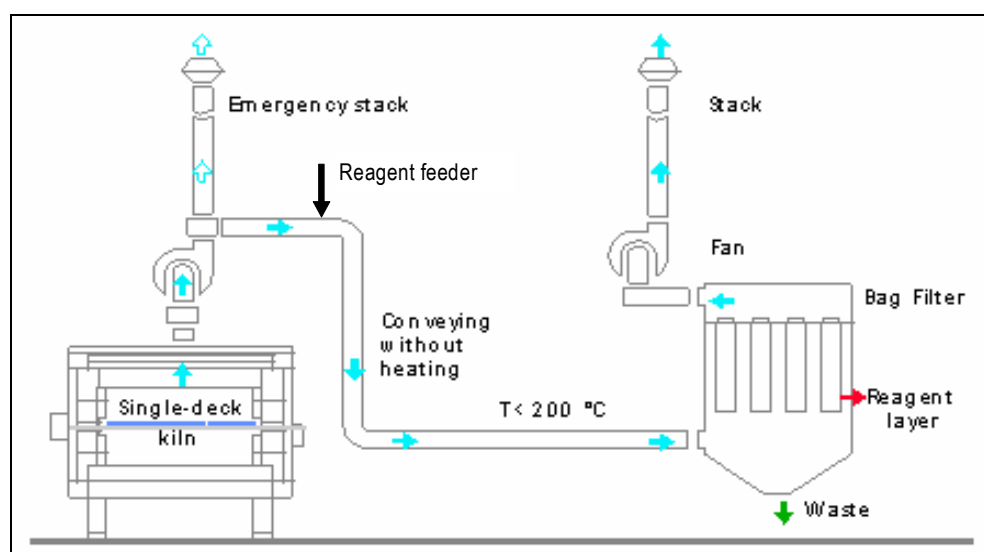

Figure 4.11: Schematic view of dry flue-gas cleaning with a bag filter

Electrostatic precipitators may be used in place of bag filters, using the same powdered reagent injection system. They offer the advantage of operating at higher gas temperatures (well over 400 °C) so no cooling of the flue-gases is necessary, and energy recovery from the cleaned gases is facilitated. On the other hand, the contact between adsorbent and pollutant is not as good as if a bag filter is used. The following figure shows a schematic view of dry flue-gas cleaning with an electrostatic precipitator [10, Navarro, 1998], [23, TWG Ceramics, 2005].

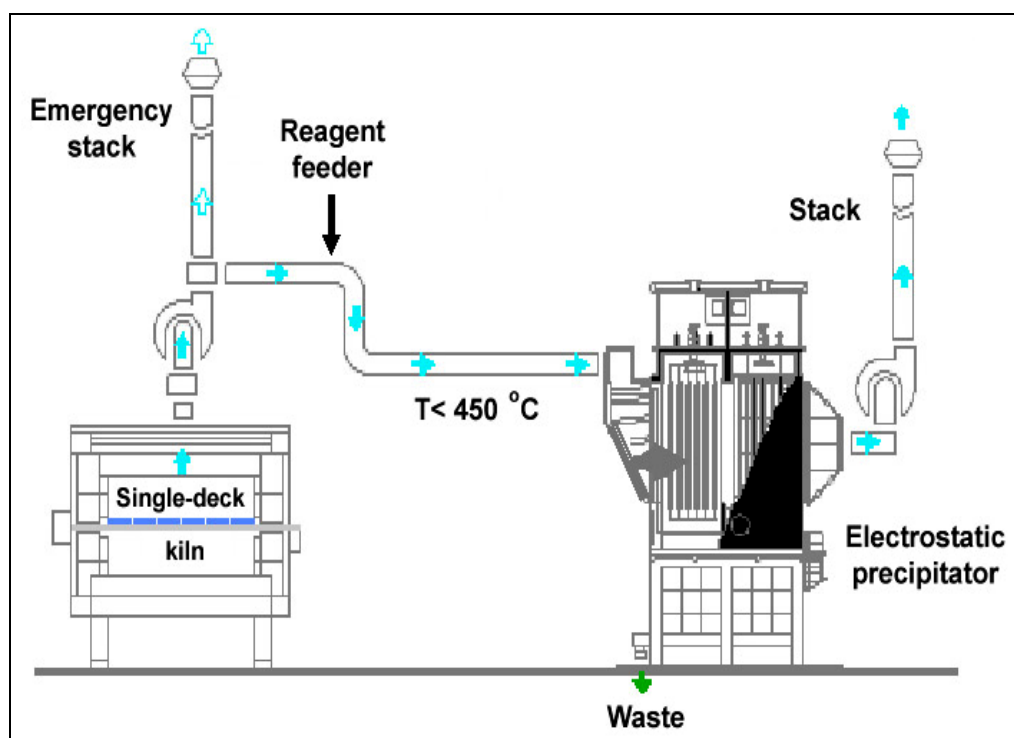

Figure 4.12: Schematic view of dry flue-gas cleaning with an electrostatic precipitator

A special variant of dry flue-gas cleaning is semi-dry flue-gas cleaning with a filter, also known as conditioned dry flue-gas cleaning. It differs from the dry method because of the use of a small quantity of water. The adsorbent is ‘conditioned’ by wetting it slightly with water, which increases the reactivity and so the cleaning efficiency is higher. Also, the consumption of adsorbents is lower and the amount of residues is smaller. The disadvantages of this technique are the likelihood of corrosion problems due to higher humidity of the flue-gases and more complex operating controls [2, VITO, 2003].

Cross-media effects

- the consumption of adsorbents causes large amounts of waste
- the recycling of waste can be problematic, due to the negative effects of calcium on the rheology of ceramic slips
- relatively high electrical energy consumption due to the pressure drop across a bag filter, respectively increased electrical energy consumption due to the operation of an ESP
- noise may increase if pneumatic filter cleaning systems are applied
- carbonate containing adsorbents react with the acidic components of the flue-gas to develop CO₂.

Operational data and applicability

The dry flue-gas cleaning system with a filter has flexibility with regard to controls and to the use of adsorbents. Calcium hydroxide (Ca(OH)₂), calcium oxide (CaO) or, more recently, sodium bicarbonate (NaHCO₃), which is most suitable for the removal of SO₂, are among the adsorbents which can be used. Additionally, it has to be mentioned that the reaction products of sodium bicarbonate consist of water-soluble salts (sodium sulphate and sodium fluoride) and as a result cannot easily be disposed of by landfill.

For cleaning systems with a bag filter, problems can occur at very high temperatures, where the filter could start burning, and at very low temperatures close to the dew point, the filter is easily clogged. The cleaning system with an electrostatic precipitator has the advantage of being able to run at high temperatures, easily exceeding 400 °C, so that no cooling of the flue-gases is required prior to cleaning, and energy recovery from the clean gases is facilitated.

A dry flue-gas cleaning system with a bag filter allows the achievement of fluoride concentrations in the treated flue-gas of less than 5 mg/m³ and suspended dust concentrations in the range of 2 – 20 mg/m³. The cleaning efficiency of these systems varies from 90 up to 99 % for the retention of suspended particulates, 92 up to 95 % for fluoride retention, 10 up to 80 % for SO₂, up to 90 % for SO₃ as well as up to 85 % for HCl, if calcium hydroxide is used as the adsorbent [2, VITO, 2003, 10, Navarro, 1998], [23, TWG Ceramics, 2005], [30, TWG Ceramics, 2005].

Additionally to an approximate cleaning efficiency of 99 % for suspended particulates, more than 95 % for fluoride retention, 98 to 99 % for SO₂ and SO₃ as well as 89 % for HCl, can be achieved, if sodium bicarbonate is used as the adsorbent in a dry flue-gas cleaning system with a bag filter (see Section 4.3.6) [4, UBA, 2001].

The cleaning system with an electrostatic precipitator has the advantage of being able to run at temperatures of up to approx. 450 °C, so that no cooling of the flue-gases is required prior to cleaning and energy recovery from the clean gases is facilitated. Achievable dust clean gas concentrations in the range of 5 – 50 mg/m³ are reported from flue-gas cleaning with electrostatic precipitators (see Section 4.2.3.5).

Dry flue-gas cleaning systems with a filter can, in principle, be applied to clean kiln flue-gases in all ceramic sectors, but the disadvantages – compared to the packed bed adsorber systems – regarding the greater need for maintenance and problems with the durability of the filter bags (in the case of a system with a bag filter) have to be taken into account.

Economics

In this context – for dry sorption with bag filter – see Table 4.7.

- For semi-dry systems, the investment cost is usually slightly higher than for a wholly dry unit
- sodium bicarbonate is more expensive than calcium-based adsorbents
- additional disposal costs for saturated adsorbents which cannot be re-used, have to be taken into account.

Driving force for implementation

Legal requirements.

Example plants and reference literature

[2, VITO, 2003], [3, CERAME-UNIE, 2003], [10, Navarro, 1998], [4, UBA, 2001], [17, Burkart, 2004], [23, TWG Ceramics, 2005], [26, UBA, 2005], [32, TWG Ceramics, 2006]

4.3.4.4 Wet flue-gas cleaning

Description and achieved environmental benefits

With wet flue-gas cleaning, the acid components (sulphur oxides, inorganic chlorine and fluorine compounds) are removed from the flue-gases by placing them in intense contact with water. This results in the components transferring from the gas to the water phase. The extent to which this takes place is dependent on the solubility of the components in question. In order to increase solubility, a base such as calcium carbonate (CaCO₃), calcium hydroxide (Ca(OH)₂), sodium carbonate (Na₂CO₃), sodium hydroxide (NaOH) or ammonia (NH₃) can be added to the water.

An illustration of a wet flue-gas cleaning unit is shown in the following figure [2, VITO, 2003]. A unit such as this consists of a preparation unit for the scrubbing liquid, a scrubbing section, a solid-liquid separator and possibly a water treatment unit and drip collector. Plates or inert packing material (packed columns) may be used in order to increase the contact area. In addition to column scrubbers, there are also jet scrubbers, venturi scrubbers and rotating scrubbers.

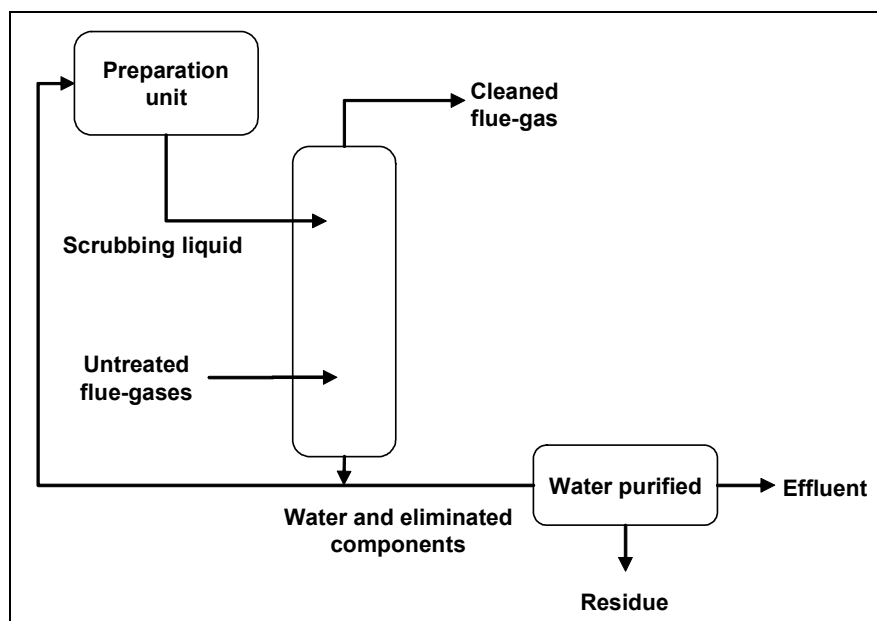

Figure 4.13: Illustration of a wet flue-gas cleaning unit

In wet scrubbing systems, the flue-gas is cooled down first and then cleaned. Additionally, a neutralisation unit and a solid separation unit are necessary in the wet process.

A special variant of wet flue-gas cleaning is semi-wet flue-gas cleaning, where due to a lower quantity of water, evaporation is enabled. Consequently, a dry residue is created which has reacted very efficiently and which can be separated using a filter. The method requires higher flue-gas temperatures in order to maintain sufficiently high temperatures at the filter following energy losses due to evaporation. Semi-wet systems have the advantages of a lower consumption of adsorbents, smaller amounts of residues and higher cleaning efficiencies, but they need more complex operating controls [2, VITO, 2003].

Cross-media effects

- high water consumption
- generation of process waste water (not to the same extent for semi-wet systems) results in the need for process waste water treatment
- relatively high electricity consumption due to the pressure drop across the units
- absorbents which contain carbonate, react with the acidic components of the flue-gas to develop CO₂.

Operational data

For removal of HF, HCl and SO_x by wet flue-gas cleaning, lime is generally used as the absorbent. Here, a solution of calcium hydroxide (milk of lime) or a suspension of calcium carbonate in water is atomised in a spray column. As a waste product, usually a slightly impure plaster is formed. Purification efficiencies of 99 % for HF, up to 98 % for SO₂, 95 % for SO₃ and up to 95 % for HCl are achievable [2, VITO, 2003], [4, UBA, 2001].

Sodium fluoride (NaF), sodium sulphite (Na₂SO₃) and sodium chloride (NaCl) are formed if soda lye (caustic) is applied as a sorption agent in a packed-bed column. The waste occurring in the washing agent has to be disposed of after evaporation. The achievable purification efficiencies, using soda lye as the washing agent, are 98 % for HF, up to 98 % for SO₂, 96 % for SO₃ and up to 98 % for HCl [4, UBA, 2001].

A possible problem with wet flue-gas cleaning is corrosion. Gases leaving the scrubbing towers are saturated with water and can cause corrosion on cooling down to below the dew point. Furthermore, these cold gases diffuse less readily in the atmosphere and give rise to a moisture plume, and as a result it is sometimes advisable to reheat the flue-gases.

Applicability

Wet flue-gas cleaning systems can, in principle, be applied in all ceramic sectors. Especially in cases where high SO₂ concentrations are present in the flue-gas and dry sorption plants cannot achieve low clean gas concentrations, the use of wet processes offers an alternative to dry sorption systems. In practice however, the application of wet processes is strongly limited by their high investment and maintenance costs.

Especially in cases in which high concentrations of inorganic pollutants are emitted simultaneously, e.g. for a high SO₂ content above 2500 mg/m³, wet processes offer an alternative to dry purification systems.

Economics

In this context, see Table 4.7. Possible shorter lifetime cycles of the systems, caused by corrosion, also have to be taken into account.

Driving force for implementation

Legal requirements.

Example plants and reference literature

Plant Hallerndorf-Pautzfeld, Germany (manufacture of expanded clay aggregates) [26, UBA, 2005], [2, VITO, 2003], [3, CERAME-UNIE, 2003], [4, UBA, 2001], [23, TWG Ceramics, 2005]

4.3.4.5 Activated carbon filters

Description, achieved environmental benefits, operational data and applicability

Activated carbon filters are only suited for cleaning low off-gas volumes of volatile organic compounds (VOC), for instance, released as volatile reaction products by heat treatment of resins, which are used as binders.

Particulate matter and droplets have to be eliminated from the gas stream prior to the carbon filter. Whereas some organic compounds (e.g. phenol and naphthalene) are retained by activated carbon, others are not effectively absorbed.

Activated carbon filters are applied mainly in the manufacturing process of refractory products.

Cross-media effects

- increased amount of waste, if activated carbon has to be disposed of and cannot be regenerated
- increased energy consumption due to the operation of the activated carbon filter.

Economics

High costs, especially if the activated carbon filters have to be disposed of and cannot be regenerated.

Driving force for implementation

Legal requirements.

Example plants and reference literature

[3, CERAME-UNIE, 2003], [4, UBA, 2001], [23, TWG Ceramics, 2005]

4.3.4.6 Biological scrubbers

Description and achieved environmental benefits

Volatile reaction products, which are released by the heat treatment of resins used as binders in the refractory industry, in the manufacture of some technical ceramics and some inorganic bonded abrasives, include ammonia, formaldehyde and phenol. These can be removed from the flue-gases with suitable scrubbing liquids. The application of a biological scrubber is a variant in which the absorbent medium is regenerated. The solubility of the pollutants in water and a constant continuous feed into the biological scrubber are necessary conditions.

Cross-media effects

- increased water consumption and process waste water are possible
- increased energy consumption due to the operation of the biological scrubber.

Applicability

Biological scrubbers can be applied in the manufacturing processes of refractory products and also in the manufacture of some technical ceramics along with some inorganic bonded abrasives.

Driving force for implementation

Legal requirements.

Example plants and reference literature

[3, CERAME-UNIE, 2003], [14, UBA, 2004], [23, TWG Ceramics, 2005]

4.3.5 Afterburning

In this context, useful information can also be found in the BREF on Common Waste Water and Waste Gas Treatment/Management Systems in the Chemical Sector.

4.3.5.1 Thermal afterburning

Description and achieved environmental benefits

Incineration of VOC carbonisation gases outside the kiln can be achieved in thermoreactors. These contain two or three chambers filled with ceramic or SiO₂ elements having a high heat storage capacity. It is carried out preferably in the case of raw gas values of more than 100 - 150 mg VOC/m³, depending on the raw gas characteristics (e.g. temperature, composition).

Flue-gases containing VOC are passed through the first chamber and absorb the heat stored in it. As they leave the first chamber and enter the incineration compartment, they are already approaching incineration temperature. In the incineration compartment, they are further heated up to 750 to 800 °C using burners, such that the organic substances are practically fully burned. The CO present in the flue-gases is also further oxidised into CO₂. Moreover, providing the temperature is at least 800 °C and the residence period at least 1.5 seconds, 90 % destruction of any dioxins present/formed is achieved.

The hot purified gases leaving the incineration compartment are subsequently passed through the second chamber, where they give up the greater part of their heat again. The gas which has been cooled down leaves the second chamber and is discharged through the chimney. After a certain period of time, when the first chamber has cooled down sufficiently and the second chamber is sufficiently hot, the direction of the gas flow is reversed. The second chamber then heats up the untreated gases and the first chamber cools the purified gases down.

If a third chamber is present in a thermoreactor, it is used to avoid emission peaks when the gas flow direction is reversed. After the gas flow direction has been reversed, small volumes of scavenging air are passed through this chamber to ensure that no untreated gases can reach the stack.

The following figure shows a schematic view of a thermal afterburning system in a thermoreactor (three-chamber system) [4, UBA, 2001], [23, TWG Ceramics, 2005].

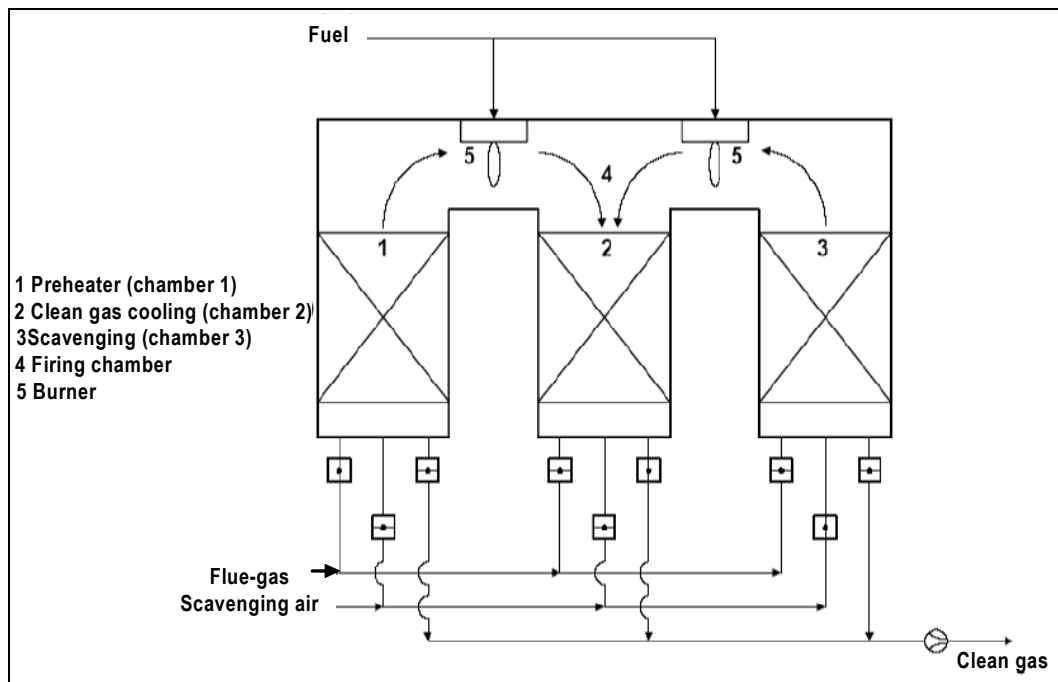

Figure 4.14: Schematic view of a thermal afterburning system in a thermoreactor (three-chamber system)

The following figure presents flue-gas conduction in an external thermal afterburning system [4, UBA, 2001].

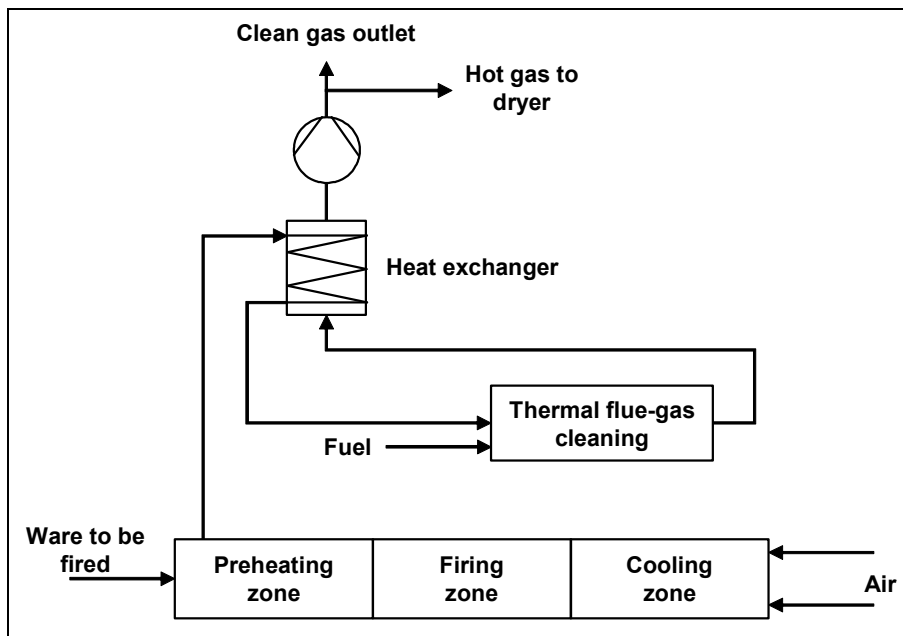

Figure 4.15: Flue-gas conduction in an external thermal afterburning system

Cross-media effects

- additional fuel needed, at least for the start-up of the operation and VOC concentration below auto ignition point
- additional NO_x emissions possible.

Operational data and applicability

If the VOC and CO concentrations are high enough, incineration is virtually autothermic. In such cases, no additional energy needs to be added in order to maintain the incineration process. This occurs mainly in the manufacture of highly porous bricks, where large quantities of organic pore-forming substances are added to the raw material mixture.

Thermo reactors have been used increasingly in recent years in the clay processing industry, especially in clay block manufacture, where organic pore-forming substances are added to the raw material mixture, and also to reduce VOC emissions from the manufacturing processes of other ceramic products, for instance refractory products, technical ceramics and some inorganic bonded abrasives. These systems have the advantage, compared with internal incineration systems, of not interfering with the normal operation of the kiln and that the flue-gas stream is purified in its entirety. There is the problem of high water content in the gases in the manufacture of expanded clay aggregates.

Depending on the required cleaning efficiency, thermoreactors are installed as two- or three-chamber plants. With 2-chamber plants, purification efficiencies of between 94 and 97 % are achievable, whereas 3-chamber plants achieve purification efficiencies of more than 99 % without problems [4, UBA, 2001].

In this context, see also Table 3.6 regarding emissions from brick manufacturing processes and Table 3.54 regarding emissions from manufacturing processes of technical ceramics (bonded abrasives). In these manufacturing processes, thermal afterburners are applied for flue-gas cleaning.

Economics

In this context, see Table 4.7.

- to economise on fuel, thermal afterburning of VOCs and CO is carried out preferably with regenerative heat exchange
- the lower the VOC and CO concentrations in the raw gas, the more energy that needs to be added to keep the thermoreactor in operation and, therefore the higher the cost.

Driving force for implementation

Legal requirements combined with energy efficient process techniques.

Example plants and reference literature

Wienerberger Ziegelindustrie AG/Werk Hennersdorf, brick plant, Austria [1, BMLFUW, 2003], [2, VITO, 2003], [3, CERAME-UNIE, 2003], [4, UBA, 2001], [14, UBA, 2004], [23, TWG Ceramics, 2005], [32, TWG Ceramics, 2006]

4.3.5.2 Catalytic afterburningDescription and achieved environmental benefits

In this VOC abatement technique, volatile organic pollutants are oxidised by passing the flue-gases over a catalytic surface which accelerates the oxidation reaction. The catalyst lowers the temperature for the oxidation of the organic pollutants to temperatures of between 200 and 300 °C. Catalysts with compounds of metal oxides or noble metals (e.g. Pd, Pt and Rh) are mainly used.

Cross-media effects

The catalysts involved will readily oxidise SO₂ to SO₃, which is a more toxic and corrosive compound.

Applicability

Catalytic oxidation is difficult to apply in the clay processing industry because the catalysts used are quickly poisoned by the impurities present in the flue-gases (e.g. sulphur compounds). Therefore, catalytic afterburning is employed predominantly for cleaning small flue-gas flows with a high content of total-C, which arise for instance, when firing special refractory or technical ceramic products in small kilns or in the drying process.

Driving force for implementation

Legal requirements.

Example plants and reference literature

[2, VITO, 2003], [3, CERAME-UNIE, 2003], [4, UBA, 2001], [23, TWG Ceramics, 2005]

4.3.6 Examples of operational data, efficiencies, consumption and cost data for different flue-gas cleaning techniques

The next table shows some examples of operational data, efficiencies, consumption and cost data for different flue-gas cleaning techniques [2, VITO, 2003] [30, TWG Ceramics, 2005]:

Technique	Cascade-type bed adsorbers	Cascade-type bed adsorbers	Cascade-type bed adsorbers	Dry flue-gas cleaning with a filter	Dry flue-gas cleaning with a filter	Wet flue-gas cleaning	Wet flue-gas cleaning	
Emission value		SO ₂ <1500 mg/Nm ³	SO ₂ ≥2500 mg/Nm ³					
Adsorbent	CaCO ₃	Modified CaCO ₃	Modified CaCO ₃	Ca(OH) ₂	NaHCO ₃	Water/Ca(OH) ₂ or CaCO ₃	Soda lye (caustic)	
Cleaning efficiency	HF	90 % (up to 99 %)	up to 99 %	up to 99 %	80 up to 96 %	> 95 %	92 – 99 %	98 %
	SO ₂	8 – 20 %	43 up to 85 %	30 – 43 %	7 up to 80 %	98 – 99 %	20 up to 98 %	90 – 98 %
	SO ₃	80 %	80 – 85 %	80 – 85 %	up to 90 %	98 – 99 %	92 – 95 %	94 – 96 %
	HCl	50 %	> 50 %	50 %	10 up to 85 %	89 %	50 up to 95 %	90 – 98 %
	Dust	100 %	100 %	99 %	90 – 99 %	99 %		100 %
Excess dosing of adsorbent ^A	2.5	2.5	2.5	1.35 – 2.00		1.01 – 2.00		
Water consumption (m ³ /day) ^B	0	0	0	0		86 – 240		
Electricity consumption (kWh/day) ^B	641 - 864	864	864	1200 – 2880		2352 – 4824		
Costs of adsorbent (EUR/tonne)	59	99	99	104		30 – 100		
Investment costs (EUR 10 ³) ^{B, C}	228 – 278	692	692	766 – 1081		511 – 659		
^A This is taken to mean: the ratio between the quantity of adsorbent required in practice to achieve the stated cleaning efficiency to the quantity of adsorbent that would be required in theory (based on the stoichiometry of the adsorption reaction).								
^B The range refers to the values submitted for four typical companies.								
^C Installation and additional costs.								

Table 4.5: Technical parameters, efficiencies, consumption and cost data for flue-gas cleaning techniques

Reduction efficiencies as a result of process-integrated measures and end-of-pipe techniques are shown in the next two tables. End-of pipe techniques mainly have an effect on the HF reduction. Process-integrated measures only effect the reduction of SO_x. The examples also show the reduction efficiencies regarding the dependency of the sulphur content in the clay [2, VITO, 2003] [30, TWG Ceramics, 2005].

Example	1	2	3	4
Technique	Dry flue-gas cleaning with filter	Cascade-type bed adsorber	Cascade-type bed adsorber	Cascade-type bed adsorber
Raw material	High sulphur clay	High sulphur clay	High sulphur clay	High sulphur clay
Emission value	$SO_x > 1500 \text{ mg/m}^3$	$SO_x > 1500 \text{ mg/m}^3$	$SO_x \geq 2500 \text{ mg/m}^3$	$SO_x \geq 2500 \text{ mg/m}^3$
Process-integrated measures	Addition of raw materials containing low sulphur and calcium	Addition of raw materials containing low sulphur and calcium	Addition of raw materials containing low sulphur and calcium	Addition of raw materials containing low sulphur and calcium; calcium rich additives
Adsorbent	$Ca(OH)_2$	$CaCO_3$	$CaCO_3$	$CaCO_3$
Reduction efficiency	HF	up to 96 %	up to 92 %	up to 83 %
	SO_x	up to 7 %	up to 20 %	up to 24 %
	HCl	0 %	up to 57 %	up to 22 %
	Dust	up to 92 %	up to 80 %	up to 58 %

Example	5	6	7	8
Technique	Dry flue-gas cleaning with filter	Cascade-type bed adsorber	Cascade-type bed adsorber	Cascade-type bed adsorber
Raw material	High sulphur clay	Low sulphur clay	Low sulphur clay	Low sulphur clay
Emission value	$SO_x > 1500 \text{ mg/m}^3$	$SO_x < 500 \text{ mg/m}^3$	$SO_x < 500 \text{ mg/m}^3$	$SO_x < 500 \text{ mg/m}^3$
Process-integrated measures	-	-	-	-
Adsorbent	$Ca(OH)_2$	$CaCO_3$	$CaCO_3$	$CaCO_3$
Reduction efficiency	HF	up to 95 %	up to 99 %	up to 99 %
	SO_x	up to 34 %	0 %	up to 63 %
	HCl	up to 83 %	0 %	up to 94 %
	Dust	0 %	up to 37 %	up to 83 %

Table 4.6: Reduction efficiencies regarding the dependency of the sulphur content in the raw material

In this context, see Table 3.8 and Table 3.9 regarding the corresponding operating data, raw and clean gas concentrations of clay block and facing brick manufacturing kilns [32, TWG Ceramics, 2006].

Some examples of cost data regarding the abatement of emissions such as dust, inorganic gaseous compounds and organic gaseous compounds by using different abatement techniques are shown for investment, maintenance and sorbent as well as operational costs in Table 4.7. However, this information cannot be used to directly compare individual techniques since the real cost will depend on factors such as flowrate, level of control, raw gas values, energy, etc. The aim is to provide a general view of the level of investment that could be involved in the different techniques [3, CERAME-UNIE, 2003], [2, VITO, 2003], [4, UBA, 2001], [30, TWG Ceramics, 2005], [32, TWG Ceramics, 2006].

Cleaning system/type	Field of application	Absorbent /adsorbent	Common sizes/ flowrates for the ceramic industry (Am ³ /h) ¹⁾	Rough investment guideline (EUR)	Maintenance (EUR/yr)	Sorbent cost (EUR/tonne) (EUR/yr)	Operation cost EUR/t
Dust abatement							
Bag filter/bag house	Complete areas in the plant, preparation, conveying, storage, forming area, handing over locations, etc.		900 to 70000	6000 – 150000 (Depending on size and amount of ductwork)			0.03 – 0.1
Central vacuum cleaner	Complete areas in the plant, preparation, conveying, storage, forming area, handing over locations, Kiln cars etc.		900 to 1000	25000 – 65000 (Depending on amount of ductwork /pipes)			
Kiln car cleaning system (In different execution: Fixed nozzle, moving nozzle, lifting and adjusting of the plateau)	Kiln cars		8000 to 30000	40000 – 200000 (Depending on size and execution)			
Electrostatic precipitator	Dust abatement for hot and large off-gas streams		Up to 100000	1000000 – 3000000			0.1 – 0.2
Inorganic gaseous compounds abatement							
Module system	Mainly HF reduction	Ca(OH) ₂ Honeycomb	Very low flowrates	45000 – 100000	~500	~46000 EUR/yr	
Cascade type packed bed absorber	Mainly HF reduction	CaCO ₃	2500 to 140000 (no lower or upper limit)	40000 – 500000	~2000	30 – 55 EUR/tonne (delivered) 4000 – 30000 EUR/yr	23400 – 4800
Cascade type packed bed absorber	Mainly HF, HCL and SO _x reduction	Modified/fabricated absorbent	2500 to 140000 (no lower or upper limit)	40000 – 500000	~2000	95 – 110 EUR/tonne (delivered) up to 60000 EUR/yr	

Inorganic gaseous compounds abatement (cont)							
Countercurrent type packed bed absorber/ series modules	Mainly HF, HCL, and SO _x reduction	CaCO ₃ and modified/ fabricated absorbent	2500 to 140000 (no lower or upper limit)	80000 – 800000	~2500	30 – 55 EUR/tonne (delivered) respectively 95 – 110 EUR/tonne (delivered)	
Dry sorption with bag filter (fly stream system)	Mainly HF, HCL, SO _x Particulate reduction	Ca(OH) ₂ in different qualities	2500 to 140000 (no lower or upper limit)	80000 – 1000000	~4000	95 – 110 EUR/tonne (delivered) 8000 – 45000 EUR/yr	107500 – 130700
Dry sorption with bag filter (fly stream system) with conditioning of the reaction product	Mainly HF, HCL, and SO _x Particulate reduction	Ca(OH) ₂ in different qualities (with little water added)	2500 to 140000 (no lower or upper limit)	200000 – 1600000	~6500	95 – 110 EUR/tonne (delivered) 8000 – 45000 EUR/yr	107500 – 130700
Wet scrubber	Mainly HCL and SO _x reduction	Alkali water	2500 to 140000 (no lower or upper limit)	400000 – 2000000	up to 8000	95 – 110 EUR/tonne (delivered) 8000 – 45000 EUR/yr +water	
Organic gaseous compounds abatement							
Thermal afterburning in a thermoreactor (external)	VOC reduction		10000 – 50000	180000 – 420000	500 – 4500		
Internal carbonisation gas combustion	VOC reduction			42000 – 300000	500 – 8000		
<p>Note: In the column 'common sizes/flowrates' and in the column 'rough investment guideline' there are ranges. It is reasonable to assume that the small Am³/h-figures correspond to the low investment figure in EUR and that the high Am³/h figure corresponds to the high investment figure in EUR. In between the increase is not linear, normally the more Am³/h are treated, and the cheaper the investment per Am³ is.</p> <p>¹⁾ The flowrates are given in 'actual m³' (Am³, as opposed to normal m³, standard condition) because actual flue-gas has to be treated.</p>							

Table 4.7: Costs regarding the abatement of dust, inorganic gaseous compounds and organic gaseous compounds by using different abatement techniques

4.4 Process waste water

4.4.1 Water used as a raw material

Water is a very important raw material in the ceramic manufacturing industries, but the amount used varies greatly between sectors and processes. The water added directly to ceramic body mixes does not lead to a waste water problem, as it is subsequently evaporated into the air during the drying and firing stages. Process waste water is generated mainly when clay materials are flushed out and suspended in running water during the manufacturing process steps.

4.4.2 Water used as a heat exchange vehicle

Water performs this function in cooling hydraulic systems and compressors, etc. Water used for this purpose must be clean and show low hardness to prevent scaling in the heat exchangers. The water used can circulate in closed circuits after simple cooling and/or cleaning operations and thus, water consumption corresponds to the amount of evaporated water. Because water in closed circuits for cooling operations is, in most cases, chemically conditioned to avoid corrosion or fermentation of organic matter, treatment with production waste water is usually not possible (in this context, see also the BREF on Industrial Cooling Systems).

4.4.3 Water used as a scrubbing agent

Water is also used in off-gas scrubbers (wet flue-gas cleaning systems and wet dust separators). In these systems, recycled process waste water can be used, which has been treated by a simple physical procedure (settling with or without prior chemical treatment), and can be circulated or treated again.

4.4.4 Water used as a cleaning agent

Water is used to clean the facilities, especially raw material preparation units, moulds and other casting units, glazing lines, engobing and other decoration units. Cleaning is the operation in which most water is used and which requires suitable management to achieve savings and avoid process waste water. Water consumption can be reduced if the water is treated and re-used several times in cleaning.

4.4.5 Objectives and solutions for the reduction of process waste water (emissions and consumption)

The objectives for treating the water arising in ceramic manufacturing processes involve lowering water consumption and achieving minimum process waste water emissions. To reach these objectives, process optimisation measures and process waste water treatment systems are employed.

4.4.5.1 Process optimisation

Description and achieved environmental benefits

Minimising water consumption is fundamental, and to achieve this reduction, the following process optimisation measures can be implemented:

- acting on the water circuit, installing automatic valves that prevent leaks of water when it is no longer needed
- installation of a high pressure system in the plant for cleaning purposes (or high pressure cleaning equipment)
- switching from wet off-gas cleaning systems to alternative, non-water consuming systems (cleaning by dry off-gas cleaning systems, see Section 4.2.3 and 4.3.4)
- installation of 'in-situ' waste glaze collection systems
- installation of slip conveying piping systems
- separate collection of process waste water streams from different process steps
- re-use of process waste water in the same process step, in particular repeated re-use of the cleaning water after suitable treatment.

Cross-media effects

No issues.

Operational data

The optimum solution involves re-using the arising process waste water in the same process step. To determine the maximum amount of re-usable process waste water in the plant and to design such solutions, a water balance (a so-called 'mass flow') can be drawn up setting out all points and quantities of arising process waste water as well as all the possible uses of it.

In this context, the following table shows achievable process waste water recycling ratios in different sectors of the ceramic industry. The data are German sector specific average ratios and highest achieved ratios, referring to process waste water produced [4, UBA, 2001].

Sector	Average	Highest ratio
Wall and floor tiles	70 – 80 %	100 %
Household ceramics	n.a.	50 %
Sanitaryware	30 – 50 %	50 %

Table 4.8: Achievable process waste water recycling ratios in different sectors of the ceramic industry

Varying achievable process waste water re-use ratios, referring to the process water required, are reported for the manufacture of different wall and floor tile products: from 10 % (unglazed porcelain stoneware) to 70 % (single-fired glazed tiles and glazed porcelain stoneware) [6, Timellini, 2004].

Process waste water recycling and re-use ratios are achieved by a combination of the process optimisation measures and application of the process waste water treatment systems, mentioned in Section 4.4.5.2.

Applicability

Process optimisation measures to minimise water consumption can be applied in all sectors of the ceramic industry.

Economics

This depends on the particular individual case related measure/task, but minimising water consumption in general leads to reduced fresh water costs.

Driving force for implementation

Saving costs by running processes in an efficient way.

Example plants and reference literature

[3, CERAME-UNIE, 2003], [4, UBA, 2001], [10, Navarro, 1998], [13, SYKE, 2004], [23, TWG Ceramics, 2005]

4.4.5.2 Systems of process waste water treatment

In this context, useful information can also be found in the BREF on Common Waste Water and Waste Gas Treatment/Management Systems in the Chemical Sector.

Description and achieved environmental benefits

The main process waste water treatment systems are as follows:

Homogenisation: homogenisation tanks are used to obtain a consistent composition in the water to be treated, and suppress, as far as possible, problems relating to variations in the constituents. Using such tanks yields improvement in all subsequent treatments, as the resulting homogeneity facilitates control of product additions and consistency in the operating facilities.

Aeration: this is a physical process that is frequently used in water treatment for different purposes, such as oxidation of the materials to facilitate subsequent flocculation, oxygenation of the organic compounds present in the process waste water, elimination of odours, etc. Aerating equipment may involve surface stirrers or turbines.

Sedimentation (settling): this is the partial separation of solid particles from a liquid by gravity. There are various types of settling tanks; these may be rectangular, round or lamellar.

Filtration: filtration involves the separation of suspended solids from a liquid, by putting the suspension through a porous medium that retains the solids and allows the liquid to flow through. The types used in the ceramic industry are in-depth filters, filter presses, and rotating vacuum filters.

Activated carbon absorption: this treatment is based on carbons ability to strongly absorb organic molecules present in water. This is a very suitable system for removing non-biodegradable organic substances.

Chemical precipitation: this is a process for eliminating different dissolved elements by precipitation as insoluble compounds, using reagents such as lime.

Coagulation and flocculation: the purpose of this treatment is to break up colloidal suspensions and produce particle agglomeration, e.g. by use of alums or polyelectrolyte and/or a combination of lime and metal salts.

Ion exchange and reverse osmosis: these processes serve to remove boron from the cleaning water coming from the glaze and application sections. Reverse osmosis is also applied for reducing the amount of process waste water for discharge.

By applying these measures or a combination of them, significant reductions of process waste water emissions and lower water consumption (see also Table 4.8) can be achieved.

Cross-media effects

Sedimentation/filter residues have to be disposed of, if no re-use is possible (especially if flocculation, precipitation or absorption agents are used).

Operational data and applicability

Process waste water treatment systems can be applied in all sectors of the ceramic industry, but the particular task has to be taken into consideration:

- if the process waste water is to be re-used in the body preparation process, no treatment will in principle, be required, but a homogenising tank will be needed to ensure keeping the most consistent possible characteristics
- if water is to be re-used in cleaning the facilities, water quality will need to be higher, so that sedimentation is required, following by aerating, with or without subsequent chemical treatment to remove odours
- excess process waste water which has to be disposed of externally normally requires a combination of homogenisation, flocculation, sedimentation and filtration. Also subsequent reverse osmosis is applied for reducing the amount of discharged process waste water.

As an example, the following figure shows a flow diagram of a process waste water purification plant of a porcelain tableware manufacturer which consists of a combination of the process waste water treatment systems mentioned above [4, UBA, 2001].

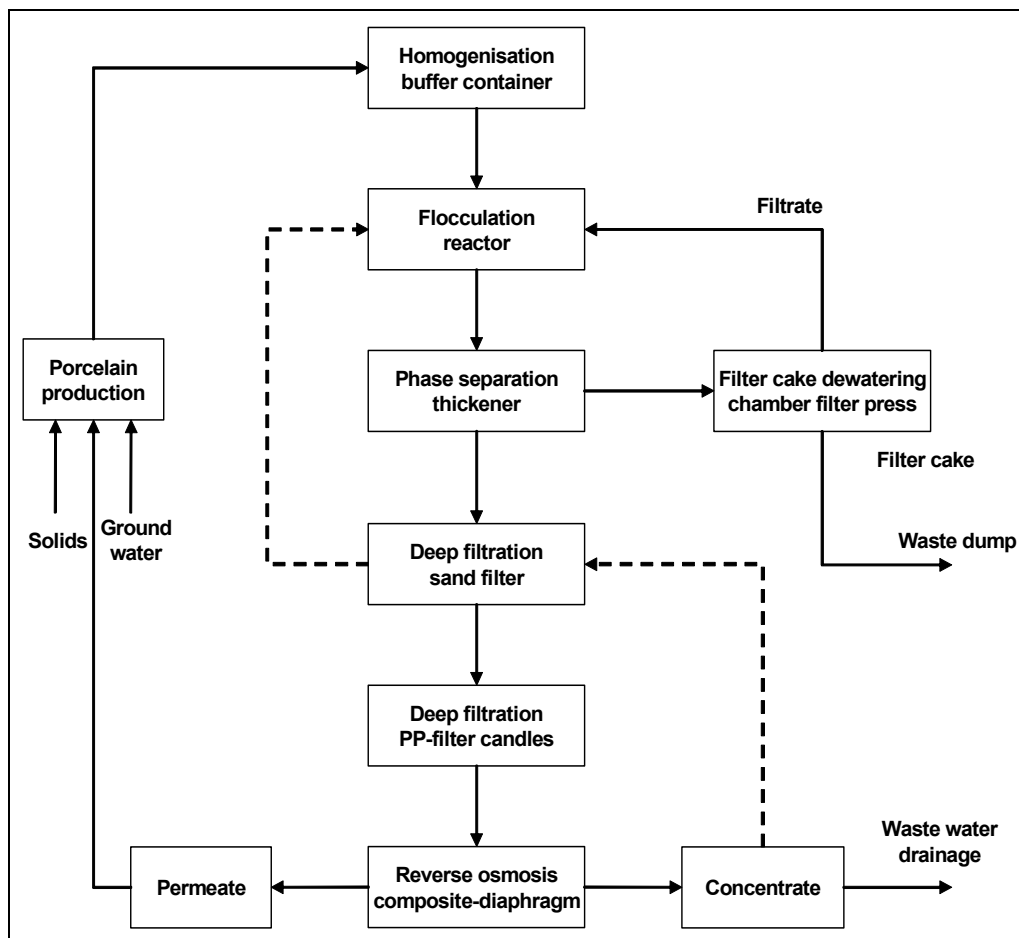

Figure 4.16: Flow diagram of a process waste water purification plant

In this context, see Table 3.38, which shows the corresponding process waste water analysis regarding the several process steps and Table 3.39, which shows a process waste water analysis of a household ceramics plant, where the cleaning is carried out with a chemical precipitation process.

See also Table 3.49, which shows the analysis of cleaned process waste water from a technical ceramics (electrical insulator) manufacturing process, where process waste water cleaning is carried out using flocculation, separation with a baffle plate thickener and filtration with a filter press, whereas Table 3.50 also shows pollutant concentrations in process waste water from an electric insulator manufacturer after flocculation, but without filtration.

Economics

If the process waste water has to be disposed of externally, the compliance with the limits specified in the existing laws requires an expensive combination of several treatment steps including sedimentation, chemical precipitation, flocculation, and a final process, based on either ion exchange or reverse osmosis, as mentioned above.

If the cleaned water from the process waste water treatment systems can be re-used, this leads to reduced fresh water costs. With a combination of process waste water recycling/re-use measures and process optimisation measures for minimisation of water consumption, costs associated with the disposal of waste materials from the above treatments can be saved.

Driving force for implementation

- legal requirements
- saving water and raw material consumption.

Example plants and reference literature

[1, BMLFUW, 2003], [3, CERAME-UNIE, 2003], [4, UBA, 2001], [10, Navarro, 1998], [13, SYKE, 2004], [23, TWG Ceramics, 2005], [30, TWG Ceramics, 2005], [31, Probst, 2005]

4.5 Process losses/waste

4.5.1 Sludge arising in the manufacture of ceramic products

4.5.1.1 Sludge recycling systems

Description and achieved environmental benefits

Recycling involves sludge re-use in the ceramic bodies as is the case with aqueous suspensions and slips containing ceramic materials, for example for the manufacturing of wall and floor tiles, see also Sections 2.3.5 and 3.3.5.

Sludge recycling systems can be easily implemented in facilities with raw materials preparation by wet milling, as the sludge can be directly used without needing any subsequent treatment, or just simple physical or physico-chemical treatments, with the additional advantage of being able to use the water that it contains as milling water. If a dry body preparation process is involved, although the sludge addition is no problem, management is more complicated as the sludge needs to be dried first.

The following figure shows the schematic view of a sludge recycling installation from a wall and floor tile plant (wet process) [4, UBA, 2001]. The sludge is pumped from the sludge storage to a 2-stage screening unit. Afterwards it passes through a deferrisation filter and then it is fed to a pre-pump storage which has a capacity of 3 m³. From there the sludge is pumped to two 200 m³ buffer basins, which are alternately filled. After a verification of the sludge characteristics and a positive result from the analysis, the sludge is fed to the main storage basin which has a capacity of 400 m³. The ceramic sludge is semi-automatically transported from the main storage basin to proportioning containers from where the drum mills for the different batches are fed.

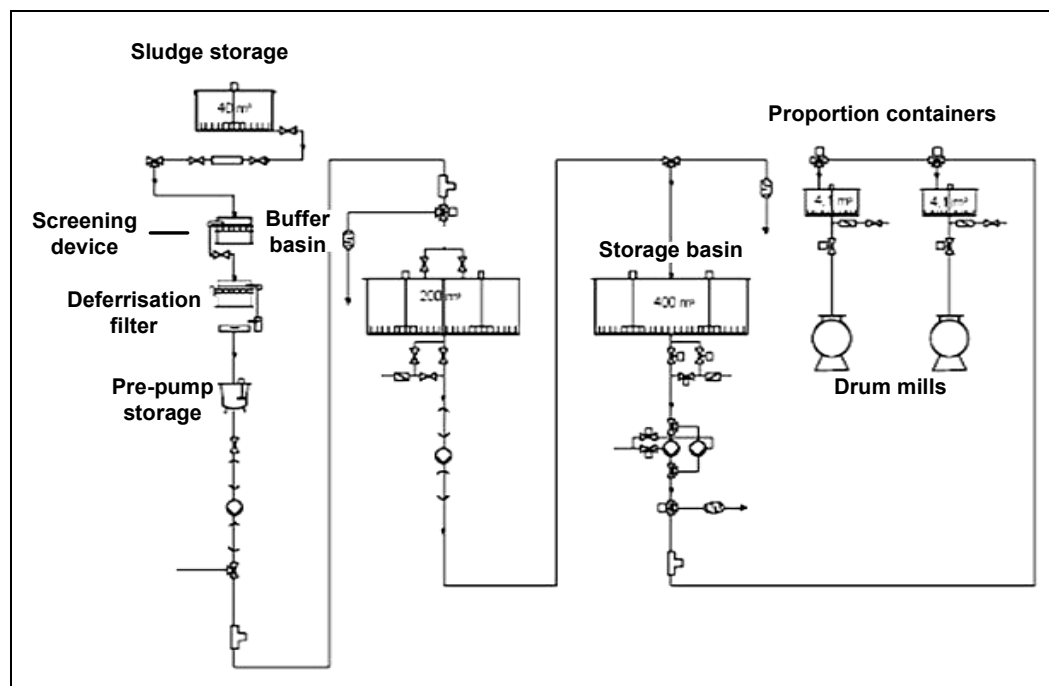

Figure 4.17: Schematic view of a sludge recycling installation

By applying a sludge recycling system, not only is there a reduction of raw material and water consumption, but also a reduction of pollutant releases into the environment can be achieved.

Cross-media effects

If sludge has to be dried for re-use, energy consumption will rise. Attention should also be paid to possible negative consequences from the fact that pollutants coming from a given phase/section of the process/plant, such as glaze preparation and application, are introduced in a different phase/section, such as ceramic body preparation. The controls of gaseous emissions and process waste water represent a suitable solution to prevent such negative consequences.

Operational data and applicability

The quantity of sludge produced in a wall and floor tile facility ranges from 0.09 – 0.15 kg/m² finished product on a dry basis, which, for a product with a body mass of 15 – 20 kg/m², involves 0.4 – 1.0 % (kg dry sludge/kg ceramic body). If all the sludge arising from the treatment of the waste water produced in the process is re-used in the ceramic body preparation process, the addition relative to the body's raw materials is, therefore, around 0.4 – 1.0 % on a dry basis. It has been found, that 1 - 1.5 per cent sludge addition to the ceramic bodies prepared for the manufacture of tiles, does not generally affect the behaviour of the products during the manufacturing process [10, Navarro, 1998], [32, TWG Ceramics, 2006].

Consequently, both in terms of the mass balance and the resulting change in behaviour, the complete incorporation of sludge in wet milling processes is technically feasible and facilitates process management.

In the case of wet processes in which the ceramic body preparation plant is an independent facility, or if it stands separately from the production facility, the sludge can be returned by road. The aqueous suspensions and sludge can be returned by tankers or conveyed by pipeline.

Using sludge that contains glaze waste as a glaze constituent would, in principle, seem to be a very suitable option. But the main drawback in this process is the considerable heterogeneity across time of the sludge compositions, owing to the diversity of glazes usually found in production at the same time in most companies. And also this sludge cannot be the sole glaze constituent, but is considered an additive (e.g. used as a fluxing agent). Although it may be a very good solution in some cases, especially if only one or a few different glazes are applied in a facility, the use of this kind of sludge in glaze preparation cannot be considered a general solution.

Sludge re-use is, therefore, not applicable in all cases. If there are special requirements on quality or performance, sludge is only re-usable in other products (see Section 4.5.1.2).

Economics

Sludge recycling/re-use leads to avoid – and therefore save – the disposal costs.

Driving force for implementation

Saving costs by saving raw material and water consumption and avoiding waste.

Example plants and reference literature

[3, CERAME-UNIE, 2003], [4, UBA, 2001], [6, Timellini, 2004], [10, Navarro, 1998], [13, SYKE, 2004], [23, TWG Ceramics, 2005], [32, TWG Ceramics, 2006]

4.5.1.2 Sludge re-use in other products

Description and achieved environmental benefits

Sludge may be re-used in sectors of the ceramic industry which are different from the ceramic sector generating the sludge, because this may involve technically interesting or economically advantageous solutions. For instance, sludge from the manufacture of household ceramics or sanitaryware can be used as a raw material/additive input in clay block making and in the manufacture of expanded clay aggregates.

This leads, on the one hand, to the avoidance of waste and, on the other hand, to raw material savings.

Cross-media effects

If sludge has to be dried for re-use, energy consumption will rise. Attention should also be paid to possible negative consequences from the fact that pollutants coming from a given phase/section/sector of the process/plant/industry, such as glaze preparation and application in the manufacture of household ceramics, are introduced in a different phase/section/sector, such as body preparation in a brickworks. The controls of gaseous emissions and process waste water represent a suitable solution to prevent such negative consequences.

Operational data and applicability

The melting temperatures of glazes, which are part of the sludge, and the fluxing properties must be taken into consideration, if sludge is to be re-used in the manufacturing of building products, because this can affect their product properties.

Economics and driving force for implementation

Saving money by saving raw materials and disposal costs.

Example plants and reference literature

[3, CERAME-UNIE, 2003], [13, SYKE, 2004], [22, SYKE, 2004], [23, TWG Ceramics, 2005]

4.5.2 Solid process losses/solid waste

This section deals with possibilities for the reduction of solid waste occurring in the several steps during the manufacturing processes of ceramic products. The solid process losses generating installations/techniques applied have already been dealt with in this document, for instance in Chapters 2 and 4 regarding dust abatement techniques.

4.5.2.1 General considerations concerning re-use of solid process losses as raw materials

Dust collected while loading, unloading, conveying, mechanically handling and processing raw materials can normally be re-used as raw material. For instance, in the storage of raw materials, any filter dust can be fed back directly to the production process or to the silo, when a local air cleaning by a silo top-filter is used. But the direct feedback may not be possible when central dedusting units are operated, because of the mixing of different raw materials.

Also, process losses, which are generated before firing, can normally be re-used as raw materials by adding them to the raw material mixture. Cuttings, used plaster moulds and also dust are the main process losses arising from the shaping process. The cut pieces from the press are often pushed from the pressing table, collected under the press and directly fed back to the material storage of the press. Furthermore, dust or cut pieces are often fed back as batch components in a casting slip or in stoneware masses. Used plaster moulds can be re-used in the cement industry or, after crushing and milling, partly in the fertiliser industry.

Dust originating from a flue-gas cleaning system can only be re-used under certain circumstances, because this dust can contain high concentrations of sulphur and fluorine. When added to the raw material mixture, this dust can result in increased emissions of HF and SO_x during the firing process. Also dust from a flue-gas cleaning system can contain adsorbent particles like lime – for instance, if an adsorption system containing lime is applied – which influences the product properties. Therefore, a separate conduction of different off-gas streams facilitates the optimal utilisation of dusty process losses. In most cases for the manufacture of expanded clay aggregates, the dust can be recycled.

Gypsum generated during flue-gas cleaning, especially in the manufacture of expanded clay aggregates or in the brick and roof tiles industry, cannot be re-used in the process, but is used in the cement industry as a hardening regulator. Materials, which cannot be recycled internally, leave the plant to be used in other industries or to be supplied to external waste recycling or waste disposal facilities.

Fired products which are unsuitable for sale (broken ware) and broken firing auxiliaries as well as broken refractory material from kilns, can in some cases after being ground, be re-used as raw materials. Broken ware which cannot be re-used in the process, can sometimes be used as a raw material input in other industries, for example broken inorganic bonded abrasive wheels are used as refractory material in steel manufacturing furnaces or as a filler in road construction. Broken bricks can be used, for example, as substrates for green roofs, tennis courts or as aggregates for special concretes.

Compared to waste disposal in landfills, the re-use of solid process losses entails:

- a reduction of raw materials used
- a reduction of pollutants released into the environment
- solid process losses re-used leads to avoid – and therefore save – the disposal costs and also some raw material costs.

[2, VITO, 2003], [3, CERAME-UNIE, 2003], [4, UBA, 2001], [23, TWG Ceramics, 2005], [26, UBA, 2005], [28, Schorcht, 2005]

4.5.2.2 General considerations on plaster moulds, firing auxiliaries and broken ware – avoidance/replacement/reduction

The application of modern techniques in the shaping process provides considerable potential to prevent waste. Processes such as slip casting in plaster moulds can be replaced by pressure slip casting units with polymer moulds. With this method, the use of plaster moulds is avoided, additionally a raw material saving of up to 20 % is achievable and the occurrence of white sludge is reduced. The use of isostatic presses with polymer moulds also avoids the need for plaster moulds. In some sectors, for instance in the manufacture of roof tiles, the use of closed metal moulds instead of open plaster moulds is possible. However, the replacement of plaster moulds is only possible if a new casting unit is built or the old one is totally renewed, which is expensive and, therefore especially for low volume business, difficult to carry out. In some cases quality problems can appear by using plaster moulds because sharp edges tend to occur. Furthermore, the metal moulds have a significantly lower exhaustion rate of the water coming out of the clay during moulding compared to plaster moulds.

The amount of used plaster moulds can also be reduced by an increase of the lifetime of the plaster moulds. The operation of automatic plaster mixers and vacuum plaster mixers permits the production of harder plaster moulds, which means that the lifetime of the moulds is two to three times longer. However, for instance, in the wet pressing process for clay roof tiles, it is usually not possible to increase the hardness of the plaster. An optimum between the porosity and surface hardness has to be found to conform with the requirements of water removal and wear resistance.

In the firing process, there are also measures for a direct prevention of waste by the use of modern techniques. If, instead of capsule or rack tunnel kiln firing, fast firing systems like roller hearth kilns are used, the amount of (used) firing auxiliaries can be reduced, but it has to be taken into consideration in this context, that the lifetime of firing auxiliaries depends on the temperature (which is typically higher in roller hearth kilns) and on handling (which is more frequent in fast firing, because firing time is shorter). Additionally, fast firing creates more rejected ceramic products – for instance tiles – when the shape is complex, because it is primarily suited for flat products and therefore, it is not applicable in all cases.

The ratio of broken ware from the firing process can be reduced by exact electronic controlling of the firing curve and by optimisation of the setting [4, UBA, 2001], [23, TWG Ceramics, 2005].

4.6 General considerations concerning noise

This section deals with possibilities for the reduction of noise occurring in the several steps during the manufacturing processes of ceramic products. Some noise generating installations/techniques applied have already been dealt with in this document on the one hand, and many noise aspects are not really sector specific on the other hand.

A reduction of sound emissions can often be achieved by directly applying measures at the source of the noise. The main sources of noise are, for example, pneumatic filter cleaning systems, compressors, motors of the preparation units as well as the handling units. Noise protection can be achieved by enclosure of the noisy unit or by building up noise protection walls. Double walls or sheathing in a double shelled construction are very efficient because, additionally, the air between the first and the second wall guarantees a higher noise protection level.

Vibrations and noise from several facilities (for example presses, crushing and mixing facilities) cannot be reduced efficiently by the above-mentioned measures, so the transfer of vibrations and noise has to be avoided by vibration insulation. Metal suspensions, rubber-metal connections and components made of felt, rubber, cork as well as a vibration insulation of the whole base with a layer of bitumen or an individual engine bed are efficient measures to reduce vibration and noise. Further measures to reduce noise emissions at the units are the use of silencers at the source of noise and the replacement of fast turning fans by larger fans with a slower rotation.

If the above-mentioned noise protection measures cannot be applied and if a transfer of noisy units inside the building is not possible, secondary noise protection measures – often at the building itself – have to be carried out. This can be achieved by thicker walls and sound insulation of the windows (multi-glass windows, which also help by saving heating costs), which have to be kept closed during noisy operations. In this context, it has to be mentioned however, that a necessity for closed windows often leads to the installation of (expensive and energy consuming) ventilation systems because of workplace conditions. Also, a transfer of windows, gates and noisy outdoor installations to a direction away from neighbouring residential areas is possible.

The operation manner of the employees also has an effect on noise emissions. Gates have to be closed if steady through traffic is not necessary, and cautious driving with trucks and forklifts at the site also reduces the noise emissions. Beyond this, time-limiting of noise intensive work, e.g. the tipping of broken ware or forklift traffic in the open air in the evening or at night, has to be avoided. Also the regular maintenance of the units by greasing, as well as the timely replacement of silencers, leads to a reduction of noise [4, UBA, 2001].

Because the driving force of a noise protection measure is normally a legal requirement (protection of neighbourhood or workplace), from the economic point of view it is mainly a matter of expense, especially if construction measures are involved.

4.7 Environmental management tools

Description

The best environmental performance is usually achieved by the installation of the best technology and its operation in the most effective and efficient manner. This is recognised by the IPPC Directive definition of ‘techniques’ as “*both the technology used and the way in which the installation is designed, built, maintained, operated and decommissioned*”.

For IPPC installations an Environmental Management System (EMS) is a tool that operators can use to address these design, construction, maintenance, operation and decommissioning issues in a systematic, demonstrable way. An EMS includes the organisational structure, responsibilities, practices, procedures, processes and resources for developing, implementing, maintaining, reviewing and monitoring the environmental policy. Environmental Management Systems are most effective and efficient where they form an inherent part of the overall management and operation of an installation.

Within the European Union, many organisations have decided on a voluntary basis to implement environmental management systems based on EN ISO 14001:2004 or the EU Eco-management and audit scheme EMAS. EMAS includes the management system requirements of EN ISO 14001, but places additional emphasis on legal compliance, environmental performance and employee involvement; it also requires external verification of the management system and validation of a public environmental statement (in EN ISO 14001 self-declaration is an alternative to external verification). There are also many organisations that have decided to put in place non-standardised EMSs.

While both standardised systems (EN ISO 14001:2004 and EMAS) and non-standardised (“customised”) systems in principle take the *organisation* as the entity, this document takes a more narrow approach, not including all activities of the organisation e.g. with regard to their products and services, due to the fact that the regulated entity under the IPPC Directive is the *installation* (as defined in Article 2).

An environmental management system (EMS) for an IPPC installation can contain the following components:

- (a) definition of an environmental policy
- (b) planning and establishing objectives and targets
- (c) implementation and operation of procedures
- (d) checking and corrective action
- (e) management review
- (f) preparation of a regular environmental statement
- (g) validation by certification body or external EMS verifier
- (h) design considerations for end-of-life plant decommissioning
- (i) development of cleaner technologies
- (j) benchmarking.

These features are explained in somewhat greater detail below. For detailed information on components (a) to (g), which are all included in EMAS, the reader is referred to the reference literature indicated below.

(a) Definition of an environmental policy

Top management are responsible for defining an environmental policy for an installation and ensuring that it:

- is appropriate to the nature, scale and environmental impacts of the activities
- includes a commitment to pollution prevention and control
- includes a commitment to comply with all relevant applicable environmental legislation and regulations, and with other requirements to which the organisation subscribes
- provides the framework for setting and reviewing environmental objectives and targets
- is documented and communicated to all employees
- is available to the public and all interested parties.

(b) Planning, i.e.:

- procedures to identify the environmental aspects of the installation, in order to determine those activities which have or can have significant impacts on the environment, and to keep this information up-to-date
- procedures to identify and have access to legal and other requirements to which the organisation subscribes and that are applicable to the environmental aspects of its activities
- establishing and reviewing documented environmental objectives and targets, taking into consideration the legal and other requirements and the views of interested parties
- establishing and regularly updating an environmental management programme, including designation of responsibility for achieving objectives and targets at each relevant function and level as well as the means and timeframe by which they are to be achieved.

(c) Implementation and operation of procedures

It is important to have systems in place to ensure that procedures are known, understood and complied with, therefore effective environmental management includes:

(i) Structure and responsibility

- defining, documenting and communicating roles, responsibilities and authorities, which includes appointing one specific management representative
- providing resources essential to the implementation and control of the environmental management system, including human resources and specialised skills, technology and financial resources.

(ii) Training, awareness and competence

- identifying training needs to ensure that all personnel whose work may significantly affect the environmental impacts of the activity have received appropriate training.

(iii) Communication

- establishing and maintaining procedures for internal communication between the various levels and functions of the installation, as well as procedures that foster a dialogue with external interested parties and procedures for receiving, documenting and, where reasonable, responding to relevant communication from external interested parties.

(iv) Employee involvement

- involving employees in the process aimed at achieving a high level of environmental performance by applying appropriate forms of participation such as the suggestion-book system or project-based group works or environmental committees.

- (v) Documentation
 - establishing and maintaining up-to-date information, in paper or electronic form, to describe the core elements of the management system and their interaction and to provide direction to related documentation.
 - (vi) Efficient process control
 - adequate control of processes under all modes of operation, i.e. preparation, start-up, routine operation, shutdown and abnormal conditions
 - identifying the key performance indicators and methods for measuring and controlling these parameters (e.g. flow, pressure, temperature, composition and quantity)
 - documenting and analysing abnormal operating conditions to identify the root causes and then addressing these to ensure that events do not recur (this can be facilitated by a ‘no-blame’ culture where the identification of causes is more important than apportioning blame to individuals).
 - (vii) Maintenance programme
 - establishing a structured programme for maintenance based on technical descriptions of the equipment, norms etc. as well as any equipment failures and consequences
 - supporting the maintenance programme by appropriate record keeping systems and diagnostic testing
 - clearly allocating responsibility for the planning and execution of maintenance.
 - (viii) Emergency preparedness and response
 - establishing and maintaining procedures to identify the potential for and response to accidents and emergency situations, and for preventing and mitigating the environmental impacts that may be associated with them.
- (d) Checking and corrective action, i.e.:
- (i) Monitoring and measurement
 - establishing and maintaining documented procedures to monitor and measure, on a regular basis, the key characteristics of operations and activities that can have a significant impact on the environment, including the recording of information for tracking performance, relevant operational controls and conformance with the installation's environmental objectives and targets (*see also the Reference document on Monitoring of Emissions*)
 - establishing and maintaining a documented procedure for periodically evaluating compliance with relevant environmental legislation and regulations.
 - (ii) Corrective and preventive action
 - establishing and maintaining procedures for defining responsibility and authority for handling and investigating non-conformance with permit conditions, other legal requirements as well as objectives and targets, taking action to mitigate any impacts caused and for initiating and completing corrective and preventive action that are appropriate to the magnitude of the problem and commensurate with the environmental impact encountered.
 - (iii) Records
 - establishing and maintaining procedures for the identification, maintenance and disposition of legible, identifiable and traceable environmental records, including training records and the results of audits and reviews.

(iv) Audit

- establishing and maintaining (a) programme(s) and procedures for periodic environmental management system audits that include discussions with personnel, inspection of operating conditions and equipment and reviewing of records and documentation and that results in a written report, to be carried out impartially and objectively by employees (internal audits) or external parties (external audits), covering the audit scope, frequency and methodologies, as well as the responsibilities and requirements for conducting audits and reporting results, in order to determine whether or not the environmental management system conforms to planned arrangements and has been properly implemented and maintained
- completing the audit or audit cycle, as appropriate, at intervals of no longer than three years, depending on the nature, scale and complexity of the activities, the significance of associated environmental impacts, the importance and urgency of the problems detected by previous audits and the history of environmental problems – more complex activities with a more significant environmental impact are audited more frequently
- having appropriate mechanisms in place to ensure that the audit results are followed up.

(v) Periodic evaluation of legal compliance

- reviewing compliance with the applicable environmental legislation and the conditions of the environmental permit(s) held by the installation
- documentation of the evaluation.

(e) Management review, i.e.:

- reviewing, by top management, at intervals that it determines, the environmental management system, to ensure its continuing suitability, adequacy and effectiveness
- ensuring that the necessary information is collected to allow management to carry out this evaluation
- documentation of the review.

(f) Preparation of a regular environmental statement:

- preparing an environmental statement that pays particular attention to the results achieved by the installation against its environmental objectives and targets. It is regularly produced – from once a year to less frequently depending on the significance of emissions, waste generation etc. It considers the information needs of relevant interested parties and it is publicly available (e.g. in electronic publications, libraries etc.).

When producing a statement, the operator may use relevant existing environmental performance indicators, making sure that the indicators chosen:

- i. give an accurate appraisal of the installation's performance
- ii. are understandable and unambiguous
- iii. allow for year on year comparison to assess the development of the environmental performance of the installation
- iv. allow for comparison with sector, national or regional benchmarks as appropriate
- v. allow for comparison with regulatory requirements as appropriate.

(g) Validation by certification body or external EMS verifier:

- having the management system, audit procedure and environmental statement examined and validated by an accredited certification body or an external EMS verifier can, if carried out properly, enhance the credibility of the system.

(h) Design considerations for end-of-life plant decommissioning

- giving consideration to the environmental impact from the eventual decommissioning of the unit at the stage of designing a new plant, as forethought makes decommissioning easier, cleaner and cheaper
- decommissioning poses environmental risks for the contamination of land (and groundwater) and generates large quantities of solid waste. Preventive techniques are process-specific but general considerations may include:
 - i. avoiding underground structures
 - ii. incorporating features that facilitate dismantling
 - iii. choosing surface finishes that are easily decontaminated
 - iv. using an equipment configuration that minimises trapped chemicals and facilitates drain-down or washing
 - v. designing flexible, self-contained units that enable phased closure
 - vi. using biodegradable and recyclable materials where possible.

(i) Development of cleaner technologies:

- environmental protection should be an inherent feature of any process design activities carried out by the operator, since techniques incorporated at the earliest possible design stage are both more effective and cheaper. Giving consideration to the development of cleaner technologies can for instance occur through R&D activities or studies. As an alternative to internal activities, arrangements can be made to keep abreast with – and where appropriate – commission work by other operators or research institutes active in the relevant field.

(j) Benchmarking, i.e.:

- carrying out systematic and regular comparisons with sector, national or regional benchmarks, including for energy efficiency and energy conservation activities, choice of input materials, emissions to air and discharges to water (using for example the European Pollutant Emission Register, EPER), consumption of water and generation of waste.

Standardised and non-standardised EMSs:

An EMS can take the form of a standardised or non-standardised (“customised”) system. Implementation and adherence to an internationally accepted standardised system such as EN ISO 14001:2004 can give higher credibility to the EMS, especially when subject to a properly performed external verification. EMAS provides additional credibility due to the interaction with the public through the environmental statement and the mechanism to ensure compliance with the applicable environmental legislation. However, non-standardised systems can in principle be equally effective provided that they are properly designed and implemented.

Achieved environmental benefits

Implementation of and adherence to an EMS focuses the attention of the operator on the environmental performance of the installation. In particular, the maintenance of and compliance with clear operating procedures for both normal and abnormal situations and the associated lines of responsibility should ensure that the installation’s permit conditions and other environmental targets and objectives are met at all times.

Environmental management systems typically ensure the continuous improvement of the environmental performance of the installation. The poorer the starting point is, the more significant short-term improvements can be expected. If the installation already has a good overall environmental performance, the system helps the operator to maintain the high performance level.

Cross-media effects

Environmental management techniques are designed to address the overall environmental impact, which is consistent with the integrated approach of the IPPC Directive.

Operational data

No specific information reported.

Applicability

The components described above can typically be applied to all IPPC installations. The scope (e.g. level of detail) and nature of the EMS (e.g. standardised or non-standardised) will generally be related to the nature, scale and complexity of the installation, and the range of environmental impacts it may have.

Economics

It is difficult to accurately determine the costs and economic benefits of introducing and maintaining a good EMS. A number of studies are presented below. However, these are just examples and their results are not entirely coherent. They might not be representative for all sectors across the EU and should thus be treated with caution.

A Swedish study carried out in 1999 surveyed all 360 ISO-certified and EMAS-registered companies in Sweden. With a response rate of 50 %, it concluded among other things that:

- the expenses for introducing and operating EMS are high but not unreasonably so, save in the case of very small companies. Expenses are expected to decrease in the future
- a higher degree of co-ordination and integration of EMS with other management systems is seen as a possible way to decrease costs
- half of all the environmental objectives and targets give payback within one year through cost savings and/or increased revenue
- the largest cost savings were made through decreased expenditure on energy, waste treatment and raw materials
- most of the companies think that their position on the market has been strengthened through the EMS. One-third of the companies report increasing revenue due to EMS.

In some Member States reduced supervision fees are charged if the installation has a certification.

A number of studies¹ show that there is an inverse relationship between company size and the cost of implementing an EMS. A similar inverse relationship exists for the payback period of invested capital. Both elements imply a less favourable cost-benefit relationship for implementing an EMS in SMEs compared to larger companies.

According to a Swiss study, the average cost for building and operating ISO 14001 can vary:

- for a company with between 1 and 49 employees: CHF 64000 (EUR 44000) for building the EMS and CHF 16000 (EUR 11000) per year for operating it
- for an industrial site with more than 250 employees: CHF 367000 (EUR 252000) for building the EMS and CHF 155000 (EUR 106000) per year for operating it.

¹ E.g. Dyllick and Hamschmidt (2000, 73) quoted in Klemisch H. and R. Holger, *Umweltmanagementsysteme in kleinen und mittleren Unternehmen – Befunde bisheriger Umsetzung*, KNI Papers 01/02, January 2002, p 15; Clausen J., M. Keil and M. Jungwirth, *The State of EMAS in the EU. Eco-Management as a Tool for Sustainable Development – Literature Study*, Institute for Ecological Economy Research (Berlin) and Ecologic – Institute for International and European Environmental Policy (Berlin), 2002, p 15.

These average figures do not necessarily represent the actual cost for a given industrial site because this cost is also highly dependent on the number of significant items (pollutants, energy consumption...) and on the complexity of the problems to be studied.

A recent German study (Schaltegger, Stefan and Wagner, Marcus, *Umweltmanagement in deutschen Unternehmen - der aktuelle Stand der Praxis*, February 2002, p. 106) shows the following costs for EMAS for different branches. It can be noted that these figures are much lower than those of the Swiss study quoted above. This is a confirmation of the difficulty to determine the costs of an EMS.

Costs for building (EUR):

minimum	- 18750
maximum	- 75000
average	- 50000

Costs for validation (EUR):

minimum	- 5000
maximum	- 12500
average	- 6000

A study by the German Institute of Entrepreneurs (Unternehmerinstitut/Arbeitsgemeinschaft Selbständiger Unternehmer UNI/ASU, 1997, *Umweltmanagementbefragung - Öko-Audit in der mittelständischen Praxis - Evaluierung und Ansätze für eine Effizienzsteigerung von Umweltmanagementsystemen in der Praxis*, Bonn.) gives information about the average savings achieved for EMAS per year and the average payback time. For example, for implementation costs of EUR 80000 they found average savings of EUR 50000 per year, corresponding to a payback time of about one and a half years.

External costs relating to verification of the system can be estimated from guidance issued by the International Accreditation Forum (<http://www.iaf.nu>).

Driving forces for implementation

Environmental management systems can provide a number of advantages, for example:

- improved insight into the environmental aspects of the company
- improved basis for decision-making
- improved motivation of personnel
- additional opportunities for operational cost reduction and product quality improvement
- improved environmental performance
- improved company image
- reduced liability, insurance and non-compliance costs
- increased attractiveness for employees, customers and investors
- increased trust of regulators, which could lead to reduced regulatory oversight
- improved relationship with environmental groups.

Example plants

The features described under (a) to (e) above are elements of EN ISO 14001:2004 and the European Community Eco-Management and Audit Scheme (EMAS), whereas the features (f) and (g) are specific to EMAS. These two standardised systems are applied in a number of IPPC installations. As an example, 357 organisations within the EU chemical and chemical products industry (NACE code 24) were EMAS registered in July 2002, most of which operate IPPC installations.

In the UK, the Environment Agency of England and Wales carried out a survey among IPC (the precursor to IPPC) regulated installations in 2001. It showed that 32 % of respondents were certified to ISO 14001 (corresponding to 21 % of all IPC installations) and 7 % were EMAS registered. All cement works in the UK (around 20) are certified to ISO 14001 and the majority are EMAS registered. In Ireland, where the establishment of an EMS (not necessarily of a standardised nature) is required in IPC licenses, an estimated 100 out of approximately 500 licensed installations have established an EMS according to ISO 14001, with the other 400 installations having opted for a non-standardised EMS.

Reference literature

(Regulation (EC) No 761/2001 of the European parliament and of the council allowing voluntary participation by organisations in a Community eco-management and audit scheme (EMAS), OJ L 114, 24/4/2001, http://europa.eu.int/comm/environment/emas/index_en.htm)

(EN ISO 14001:2004, <http://www.iso.ch/iso/en/iso9000-14000/iso14000/iso14000index.html>; <http://www.tc207.org>)

5 BEST AVAILABLE TECHNIQUES FOR CERAMIC MANUFACTURING

In understanding this chapter and its contents, the attention of the reader is drawn back to the preface of this document and in particular the fifth section of the preface: 'How to understand and use this document'. The techniques and associated emission and/or consumption levels, or ranges of levels, presented in this chapter have been assessed through an iterative process involving the following steps:

- identification of the key environmental issues for the ceramic manufacturing industry
- examination of the techniques most relevant to address these key issues
- identification of the best environmental performance levels, on the basis of the available data in the European Union and worldwide
- examination of the conditions under which these performance levels were achieved; such as costs, cross-media effects, and the main driving forces involved in implementation of the techniques
- selection of the 'Best Available Techniques (BAT)' and the associated emission and/or consumption levels for the ceramic manufacturing industry in a general sense, all according to Article 2(11) and Annex IV of the Directive.

Expert judgement by the European IPPC Bureau and the relevant Technical Working Group (TWG) has played a key role in each of these steps and in the way in which the information is presented here.

On the basis of this assessment, techniques, and as far as possible emission and consumption levels associated with the use of BAT, are presented in this chapter that are considered to be appropriate to the ceramic manufacturing industry as a whole and in many cases reflect the current performance of some installations within this industry. Where emission or consumption levels 'associated with best available techniques' are presented, this is to be understood as meaning that those levels represent the environmental performance that could be anticipated as a result of the application, in this industry, of the techniques described, bearing in mind the balance of costs and advantages inherent within the definition of BAT. However, they are neither emission nor consumption limit values and should not be understood as such. In some cases it may be technically possible to achieve better emission or consumption levels but due to the costs involved or cross-media considerations, they are not considered to be appropriate as BAT for the ceramic manufacturing industry as a whole. However, such levels may be considered to be justified in more specific cases where there are special driving forces.

The emission and consumption levels associated with the use of BAT have to be seen together with any specified reference conditions (e.g. averaging periods).

The concept of 'levels associated with BAT' described above is to be distinguished from the term 'achievable level' used elsewhere in this document. Where a level is described as 'achievable' using a particular technique or combination of techniques, this should be understood to mean that the level may be expected to be achieved over a substantial period of time in a well maintained and operated installation or process using those techniques.

Where available, data concerning costs have been given together with the description of the techniques presented in the previous chapter. These give a rough indication about the magnitude of the costs involved. However, the actual cost of applying a technique will depend strongly on the specific situation regarding, for example, taxes, fees, and the technical characteristics of the installation concerned. It is not possible to evaluate such site-specific factors fully in this document. In the absence of data concerning costs, conclusions on economic viability of techniques are drawn from observations on existing installations.

It is intended that the general BAT in this chapter are a reference point against which to judge the current performance of an existing installation or to judge a proposal for a new installation. In this way they will assist in the determination of appropriate 'BAT-based' conditions for the installation or in the establishment of general binding rules under Article 9(8). It is foreseen that new installations can be designed to perform at or even better than the general BAT levels presented here. It is also considered that existing installations could move towards the general BAT levels or do better, subject to the technical and economic applicability of the techniques in each case.

While the BAT reference documents do not set legally binding standards, they are meant to give information for the guidance of industry, Member States and the public on achievable emission and consumption levels when using specified techniques. The appropriate limit values for any specific case will need to be determined taking into account the objectives of the IPPC Directive and the local considerations.

In this document, the BAT conclusions for the ceramic manufacturing industry are set out on two levels. Section 5.1 presents generic BAT conclusions, i.e. those that are generally applicable to the whole ceramic industry. Section 5.2 contains specific BAT conclusions for each of the nine major ceramic sectors under the scope. 'Best Available Techniques' for a specific installation will usually be the use of one individual or a combination of the techniques and measures listed in this chapter under the generic and sector specific sections (Sections 5.1 and 5.2).

Where techniques identified individually as BAT can be used in combination, the effects of such combinations should be considered in drawing conclusions on BAT based permit conditions for particular cases.

Recommendation to help users/readers of this document:

It is strongly recommended to read Chapter 5 in conjunction with Chapter 4, because not only the applicability, but also the restrictions regarding the applicability of the techniques and measures as mentioned in Chapter 4 have to be taken into account. To help the reader in this, references to Chapter 4 have been included in Chapter 5.

Regarding the standard conditions for measurements of volume flows and concentrations, see the following definitions, which are also stated in the Glossary:

m ³ /h	volume flow: if not otherwise mentioned in this document, the volume flows refer to 18 vol-% oxygen and standard state.
mg/m ³	concentration: if not otherwise mentioned in this document, the concentrations of gaseous substances or mixtures of substances refer to dry flue-gas at 18 vol-% oxygen and standard state, and benzene concentrations refer to 15 vol-% oxygen and standard state.
standard state	refers to a temperature of 273 K and a pressure of 1013 hPa.

It should be stressed once again, that, as described more fully in the PREFACE, this document does not propose emission limit values. The determination of appropriate permit conditions will involve taking account of local, site-specific factors such as the technical characteristics of the installation concerned, its geographical location and the local environmental conditions. In the case of existing installations, the economic and technical viability of upgrading them also needs to be taken into account. Even the single objective of ensuring a high level of protection for the environment as a whole will often involve making trade-off judgements between different types of environmental impact, and these judgements will often be influenced by local considerations.

Although an attempt is made to address some of these issues, it is not possible for them to be considered fully in this document. The techniques and levels presented in Chapter 5 will therefore not necessarily be appropriate for all installations. On the other hand, the obligation to ensure a high level of environmental protection including the minimisation of long-distance or transboundary pollution implies that permit conditions cannot be set on the basis of purely local considerations. It is therefore of the utmost importance that the information contained in this document is fully taken into account.

5.1 Generic Best Available Techniques

This section contains general BAT conclusions regarding all nine sectors explained and described in this document. 'Best Available Techniques' for a specific installation will usually be the use of one individual or a combination of the techniques and measures listed in this generic section and in the sector specific sections (Section 5.2).

The best available techniques and presented ranges of emission or consumption levels associated with best available techniques (BAT AEL ranges) are related to installations with different kiln sizes, different kinds of kiln operation, e.g. continuously or discontinuously, and different operational hours per year. Special local consideration cannot be taken fully account. BAT AEL does not define and suggest emission limit values (ELVs).

It is strongly recommended to read Chapter 5 in conjunction with Chapter 4, because not only the applicability, but also the restrictions regarding the applicability of the techniques and measures as mentioned in Chapter 4 have to be taken into account. The BAT conclusions from this Chapter 5 cannot correctly be interpreted unless it is read in conjunction with Chapter 4. To help the reader in this, references to Chapter 4 have been included in Chapter 5.

5.1.1 Environmental management

A number of environmental management techniques are determined as BAT. The scope (e.g. level of detail) and nature of the EMS (e.g. standardised or non-standardised) will generally be related to the nature, scale and complexity of the installation, and the range of environmental impacts it may have.

BAT is to implement and adhere to an Environmental Management System (EMS) that incorporates, as appropriate to individual circumstances, the following features (see Section 4.7):

- a) definition of an environmental policy for the installation by top management (commitment of the top management is regarded as a precondition for a successful application of other features of the EMS)
- b) planning and establishing the necessary procedures
- c) implementation of the procedures, paying particular attention to:
 - I. structure and responsibility
 - II. training, awareness and competence
 - III. communication
 - IV. employee involvement
 - V. documentation
 - VI. efficient process control
 - VII. maintenance programme
 - VIII. emergency preparedness and response
 - IX. safeguarding compliance with environmental legislation.

- d) checking performance and taking corrective action, paying particular attention to
 - I. monitoring and measurement (see also the Reference document on Monitoring of Emissions)
 - II. corrective and preventive action
 - III. maintenance of records
 - IV. independent (where practicable) internal auditing in order to determine whether or not the environmental management system conforms to planned arrangements and has been properly implemented and maintained.
- e) review by top management.

Three further features, which can complement the above stepwise, are considered as supporting measures. However, their absence is generally not inconsistent with BAT. These three additional steps are:

- f) having the management system and audit procedure examined and validated by an accredited certification body or an external EMS verifier
- g) preparation and publication (and possibly external validation) of a regular environmental statement describing all the significant environmental aspects of the installation, allowing for year-by-year comparison against environmental objectives and targets as well as with sector benchmarks as appropriate
- h) implementation and adherence to an internationally accepted voluntary system such as EMAS and EN ISO 14001:2004. This voluntary step could give higher credibility to the EMS. In particular EMAS, which embodies all the above-mentioned features, gives higher credibility. However, non-standardised systems can in principle be equally effective provided that they are properly designed and implemented.

Specifically for the ceramic manufacturing industry, it is also important to consider the following potential features of the EMS:

- i) the environmental impact from the eventual decommissioning of the unit at the stage of designing a new plant
- j) the development of cleaner technologies
- k) where practicable, the application of sectoral benchmarking on a regular basis, including energy efficiency and energy conservation activities, choice of input materials, emissions to air, discharges to water, consumption of water and generation of waste.

5.1.2 Energy consumption

General considerations regarding energy consumption can be found in Section 3.2.1.

- a) **BAT is to reduce energy consumption by applying a combination of the following techniques:**
 - I. improved design of kilns and dryers. In this context, see Section 4.1.1, where several different measures are presented, which can be applied to kiln/dryer systems individually or in combination
 - II. recovery of excess heat from kilns, especially from their cooling zone (see Section 4.1.2). In particular, the kiln excess heat from the cooling zone in the form of hot air can be used to heat dryers
 - III. applying a fuel switch in the kiln firing process (substitution of heavy fuel oil and solid fuels by low emission fuels). In this context, see Section 4.1.4, regarding the switch of the kiln firing process to gaseous fuels or fuel oil EL
 - IV. modification of ceramic bodies. In this context, see Section 4.1.5, where several possibilities and applicability for the modification of ceramic bodies are presented.

- b) **BAT is to reduce primary energy consumption by applying cogeneration/combined heat and power plants (see Section 4.1.3), on the basis of useful heat demand, within energy regulatory schemes which are economically viable.**

5.1.3 Dust emissions

General considerations regarding dust emissions can be found in Section 3.1.1.1.

5.1.3.1 Diffuse dust emissions

BAT is to reduce diffuse dust emissions by applying a combination of the following techniques:

- a) measures for dusty operations. In this context, see Section 4.2.1, where several different measures are presented, which can be applied individually or in combination
- b) bulk storage area measures. In this context, see Section 4.2.2, where several different measures are presented, which can be applied individually or in combination.

5.1.3.2 Channelled dust emissions from dusty operations

Dust emissions arising from dusty operations other than from drying, spray drying or firing.

BAT is to reduce channelled dust emissions from dusty operations (see Section 4.2.3, where techniques which are aimed exclusively at dust removal are described) to 1 - 10 mg/m³, as the half hourly average value, by applying bag filters (see Section 4.2.3.2). However, this range may be higher depending on specific operating conditions.

5.1.3.3 Dust emissions from drying processes

Dust emissions arising from drying processes.

BAT is to keep dust emissions from drying processes in the range 1 - 20 mg/m³ as the daily average value by cleaning the dryer, by avoiding the accumulation of dust residues in the dryer and by adopting adequate maintenance protocols (see Section 4.2).

5.1.3.4 Dust emissions from kiln firing processes

Dust emissions arising from the kiln firing process.

BAT is to reduce dust emissions (particulate matter) from flue-gases of kiln firing processes to 1 – 20 mg/m³ as the daily average value by applying a combination of the following primary measures/techniques:

- a) utilisation of low ash fuels, e.g. natural gas, LNG, LPG and fuel oil extra light (see Section 4.1.4)
- b) minimisation of dust formation caused by the charging of the ware to be fired in the kiln (see Section 4.2).

By applying dry flue-gas cleaning with a filter (see Section 4.3.4.3), a dust emission level of less than 20 mg/m³ in the cleaned flue-gas is BAT (BAT AEL).

By applying cascade-type packed bed adsorbers (see Section 4.3.4.1), a dust emission level of less than 50 mg/m³ in the cleaned flue-gas is BAT (BAT AEL).

For expanded clay aggregates, see sector specific BAT (Section 5.2.4).

5.1.4 Gaseous compounds

General considerations regarding emissions of gaseous compounds can be found in Section 3.1.1.2.

5.1.4.1 Primary measures/techniques

- a) BAT is to reduce the emissions of gaseous compounds (i.e. HF, HCl, SO_x, VOC, heavy metals) from flue-gases of kiln firing processes by applying one or a combination of the following primary measures/techniques:**
 - I. reducing the input of pollutant precursors. In this context, see Section 4.3.1, where several possibilities for reducing the input of different pollutant precursors are presented
 - II. heating curve optimisation. In this context, see Section 4.3.3.1, where several aspects of process optimisation by optimising the heating curve of the firing process are presented.
- b) BAT is to keep the emissions of NO_x from flue-gases of kiln firing processes below 250 mg/m³, as the daily average value stated as NO₂, for kiln gas temperatures below 1300 °C, or below 500 mg/m³, as the daily average value stated as NO₂, for kiln gas temperatures of 1300 °C and higher, by applying a combination of primary measures/techniques (see Sections 4.3.1 and 4.3.3, in particular reducing the input of NO_x precursors) except for expanded clay aggregates.**
- c) BAT is to keep the emissions of NO_x from off-gases of cogeneration engines below 500 mg/m³, as the daily average value stated as NO₂, by applying process optimisation measures (see Sections 4.1.3 and 4.3.1).**

5.1.4.2 Secondary measures/techniques and in combination with primary measures/techniques

BAT is to reduce the emissions of gaseous inorganic compounds from flue-gases of kiln firing processes by applying one of the following secondary measures/techniques:

- a) cascade-type packed bed adsorbers (see Section 4.3.4.1)
- b) dry flue-gas cleaning with a filter (bag filter or electrostatic precipitator, see Section 4.3.4.3)

By applying a combination of primary measures/techniques as stated in Section 5.1.4.1.a and/or secondary measures/techniques as stated in this section, the following emission levels of gaseous inorganic compounds from flue-gases of kiln firing processes are BAT AELs:

Parameter	Unit, as a daily average value	BAT AEL ¹⁾
Fluoride stated as HF	mg/m ³	1 – 10 ²⁾
Chloride stated as HCl	mg/m ³	1 – 30 ³⁾
SO _x stated as SO ₂ Sulphur content in raw material ≤ 0.25 %	mg/m ³	<500
SO _x stated as SO ₂ Sulphur content in raw material >0.25 %	mg/m ³	500 – 2000 ⁴⁾
¹⁾ The ranges depend on the content of the pollutant (precursor) in the raw materials, i.e. for firing processes of ceramic products with a low content of the pollutant (precursor) in the raw materials, lower levels within the range are BAT and for firing processes of ceramic products with a high content of the pollutant (precursor) in the raw materials, higher levels within the range are BAT AELs.		
²⁾ The higher BAT level can be lower depending on the characteristics of the raw material.		
³⁾ The higher BAT level can be lower depending on the characteristics of the raw material. Also, the higher BAT AEL should not prevent the re-use of waste water.		
⁴⁾ The higher BAT level only applies to raw material with an extremely high sulphur content.		

Table 5.1: BAT associated emission levels for gaseous inorganic compounds from flue-gases of kiln firing processes

5.1.5 Process waste water (emissions and consumption)

General considerations regarding process waste water (emissions and consumption) can be found in Section 3.1.2 and Section 3.2.2.

- a) **BAT is to reduce water consumption by applying process optimisation measures. In this context, see Section 4.4.5.1 where several process optimisation measures are presented, which can be applied individually or in combination.**
- b) **BAT is to clean process waste water by applying process waste water treatment systems. In this context, see Section 4.4.5.2, where several process waste water treatment systems are presented, which can be applied individually or in combination to ensure that the water is adequately cleaned to be re-used in the manufacturing process or to be discharged directly into water or indirectly into a municipal waste water sewerage system.**
- c) **BAT is to reduce the emission load of pollutants in the waste water discharges. The following emission levels in waste water discharges are BAT AELs:**

Parameter	Unit	BAT AEL (2 hours composite sample)
Suspended solids	mg/l	50.0
AOX	mg/l	0.1
Lead (Pb)	mg/l	0.3
Zinc (Zn)	mg/l	2.0
Cadmium (Cd)	mg/l	0.07

Table 5.2: BAT associated emission levels of pollutants in waste water discharges

If more than 50 % of the process water is re-used in the manufacturing processes, higher concentrations of these pollutants may still be BAT AELs, as long as the specific pollutant load per production amount (kg of processed raw material) is not higher than the pollutant load resulting from a water recycling rate of less than 50 %.

5.1.6 Sludge

General considerations regarding sludge can be found in Section 3.1.3.

BAT is to recycle/re-use sludge by applying one or a combination of the following techniques:

- a) sludge recycling systems (see Section 4.5.1.1)
- b) sludge re-use in other products (see Section 4.5.1.2).

5.1.7 Solid process losses/solid waste

General considerations regarding solid process losses/solid waste can be found in Section 3.1.3.

BAT is to reduce solid process losses/solid waste by applying a combination of the following techniques:

- a) feedback of unmixed raw materials (see Section 4.5.2.1)
- b) feedback of broken ware into the manufacturing process (see Section 4.5.2.1)
- c) use of solid process losses in other industries (see Section 4.5.2.1)
- d) electronic controlling of firing (see Section 4.5.2.2)
- e) applying optimised setting (see Section 4.5.2.2).

5.1.8 Noise

General considerations regarding noise can be found in Section 3.1.4.

BAT is to reduce noise by applying a combination of the following techniques (see Section 4.6):

- a) enclosure of units
- b) vibration insulation of units
- c) using silencers and slow rotating fans
- d) situating windows, gates and noisy units away from neighbours
- e) sound insulation of windows and walls
- f) closing windows and gates
- g) carrying out noisy (outdoor) activities only during the day
- h) good maintenance of the plant.

5.2 Sector specific Best Available Techniques

This section contains specific BAT conclusions regarding each of the nine sectors explained and described in this document. ‘Best Available Techniques’ for a specific installation will usually be the use of one individual or a combination of the techniques and measures listed in this sector specific section and in the generic section (Section 5.1).

The best available techniques and presented ranges of emission or consumption levels associated with best available techniques (BAT AEL ranges) are related to installations with different kiln sizes, different kind of operation of the kiln, e.g. continuously or discontinuously, and different operational hours per year. Special local consideration cannot be taken fully account. BAT AEL does not define and suggest emission limit values (ELVs).

It is strongly recommended to read Chapter 5 in conjunction with Chapter 4, because not only the applicability, but also the restrictions regarding the applicability of the techniques and measures as mentioned in Chapter 4 have to be taken into account. The BAT conclusions from this Chapter 5 cannot correctly be interpreted unless it is read in conjunction with Chapter 4. To help the reader in this, references to Chapter 4 have been included in Chapter 5.

5.2.1 Bricks and roof tiles

5.2.1.1 Gaseous compounds/primary measures/techniques

BAT is to reduce the emissions of gaseous compounds (i.e. HF, HCl, SO_x) from the flue-gases of kiln firing processes by addition of calcium rich additives (see Section 4.3.2), if the quality of the end-product is not affected.

5.2.1.2 Volatile organic compounds

BAT is to reduce the emissions of volatile organic compounds from the flue-gases of firing processes – with raw gas concentrations of more than 100 to 150 mg/m³, depending on the raw gas characteristics, e.g. composition, temperature – to 5 – 20 mg/m³, as the daily average value stated as total C, by applying thermal afterburning either in a one or a three chamber thermoreactor (see Section 4.3.5.1).

5.2.2 Vitrified clay pipes

5.2.2.1 Channelled dust emissions

BAT is to reduce channelled dust emissions from spray glazing processes to 1 – 10 mg/m³, as the half hourly average value, by applying bag filters (see Section 4.2.3.2) or sintered lamellar filters (see Section 4.2.3.3).

5.2.3 Refractory products

5.2.3.1 Volatile organic compounds

- a) **BAT is to reduce the emissions of volatile organic compounds in low off-gas volumes from the treatment with organic compounds by applying activated carbon filters (see Section 4.3.4.5).
For high off-gas volumes, BAT is to reduce the emissions of volatile organic compounds from the treatment with organic compounds by applying thermal afterburning (see Section 4.3.5.1) to 5 – 20 mg/m³, as the daily average value stated as total C.**

- b) **BAT is to reduce the emissions of volatile organic compounds from the flue-gases of firing processes** – with raw gas concentrations of more than 100 to 150 mg/m³, depending on the raw gas characteristics, e.g. composition, temperature –to 5 - 20 mg/m³, as the daily average value stated as total C, by applying thermal afterburning either in a one or a three chamber thermoreactor (see Section 4.3.5.1).

5.2.3.2 Solid process losses/solid waste

BAT is to reduce the amount of solid process losses/solid waste in the form of used plaster moulds from the shaping by applying one individual or a combination of the following measures (see Section 4.5.2.2):

- a) replacing plaster moulds by polymer moulds
- b) replacing plaster moulds by metal moulds
- c) use of vacuum plaster mixers
- d) re-use of used plaster moulds in other industries.

5.2.4 Expanded clay aggregates

5.2.4.1 Channelled dust emissions

BAT is to reduce channelled dust emissions from hot off-gases to 5 – 50 mg/m³, as the daily average value, by applying electrostatic precipitators (see Section 4.2.3.5) or wet dust separators (see Section 4.2.3.4).

5.2.4.2 Gaseous compounds/primary measures/techniques

BAT is to keep the emissions of NO_x from the flue-gases of rotary kiln firing processes below 500 mg/m³, as the daily average value stated as NO₂, by applying a combination of primary measures/techniques (see Sections 4.3.1 and 4.3.3).

5.2.5 Wall and floor tiles

5.2.5.1 Channelled dust emissions

- a) **BAT is to reduce channelled dust emissions from spray drying processes to 1 - 30 mg/m³, as the half hourly average value, by applying bag filters (see Section 4.2.3.2), or to 1 – 50 mg/m³ by applying cyclones (see Section 4.2.3.1) in combination with wet dust separators (see Section 4.2.3.4) for existing installations, if the rinsing water can be re-used.**
- b) **BAT is to reduce channelled dust emissions from spray glazing processes to 1 - 10 mg/m³, as the half hourly average value, by applying bag filters (see Section 4.2.3.2) or sintered lamellar filters (see Section 4.2.3.3).**

5.2.5.2 Dust emissions from kiln firing processes

BAT is to reduce dust emissions (particulate matter) from the flue-gases of kiln firing processes to 1 – 5 mg/m³, as the daily average value, by applying dry flue-gas cleaning with a bag filter (see Section 4.3.4.3), also used for the removal of fluoride.

5.2.5.3 Gaseous compounds/secondary measures/techniques

- a) BAT is to reduce the emissions of HF from the flue-gases of kiln firing processes to 1 – 5 mg/m³, as the daily average value, by applying, e.g. dry flue-gas cleaning with a bag filter (see Section 4.3.4.3).
- b) BAT is to reduce the emissions of gaseous inorganic compounds from the flue-gases of kiln firing processes by applying module adsorbers (see Section 4.3.4.2), especially for lower flue-gas flowrates (below 18000 m³/h) and when raw gas concentrations of inorganic compounds other than HF (SO₂, SO₃, HCl) and of dust are low.

5.2.5.4 Re-use of process waste water

BAT is to re-use process waste water in the manufacturing process with process waste water recycling ratios of 50 – 100 % (depending on the type of tile to be manufactured, see Section 4.4.5.1) by applying a combination of process optimisation measures and process waste water treatment systems as stated in Section 4.4.5.

5.2.5.5 Re-use of sludge

BAT is to re-use the sludge arising from process waste water treatment in the ceramic body preparation process in a ratio of 0.4 - 1.5 % per weight of added dry sludge to the ceramic body, by applying a sludge recycling system (see Section 4.5.1.1), when applicable.

5.2.6 Table- and ornamental ware (household ceramics)

5.2.6.1 Channelled dust emissions

- a) BAT is to reduce channelled dust emissions from spray drying processes to 1 - 30 mg/m³, as the half hourly average value, by applying bag filters (see Section 4.2.3.2), or to 1 – 50 mg/m³ by applying cyclones (see Section 4.2.3.1) in combination with wet dust separators (see Section 4.2.3.4) for existing installations, if the rinsing water can be re-used.
- b) BAT is to reduce channelled dust emissions from spray glazing processes to 1 - 10 mg/m³, as the half hourly average value, by applying bag filters (see Section 4.2.3.2) or sintered lamellar filters (see Section 4.2.3.3).

5.2.6.2 Gaseous compounds/secondary measures/techniques

BAT is to reduce the emissions of gaseous inorganic compounds from the flue-gases of kiln firing processes by applying module adsorbers (see Section 4.3.4.2), especially for lower flue-gas flowrates (below 18000 m³/h) and when raw gas concentrations of inorganic compounds other than HF (SO₂, SO₃, HCl) and of dust are low.

5.2.6.3 Re-use of process waste water

BAT is to re-use process waste water in the manufacturing process with process waste water recycling ratios of 30 – 50 % by applying a combination of process optimisation measures and process waste water treatment systems as stated in Section 4.4.5.

5.2.6.4 Solid process losses/solid waste

BAT is to reduce the amount of solid process losses/solid waste in the form of used plaster moulds from the shaping by applying one individual or a combination of the following measures (see Section 4.5.2.2):

- a) replacing plaster moulds by polymer moulds
- b) replacing plaster moulds by metal moulds
- c) use of vacuum plaster mixers
- d) re-use of used plaster moulds in other industries.

5.2.7 Sanitaryware

5.2.7.1 Channelled dust emissions

BAT is to reduce channelled dust emissions from spray glazing processes to 1 – 10 mg/m³, as the half hourly average value, by applying bag filters (see Section 4.2.3.2) or sintered lamellar filters (see Section 4.2.3.3).

5.2.7.2 Gaseous compounds/secondary measures/techniques

BAT is to reduce the emissions of gaseous inorganic compounds from the flue-gases of kiln firing processes by applying module adsorbers (see Section 4.3.4.2), especially for lower flue-gas flowrates (below 18000 m³/h) and when raw gas concentrations of inorganic compounds other than HF (SO₂, SO₃, HCl) and of dust are low.

5.2.7.3 Re-use of process waste water

BAT is to re-use process waste water in the manufacturing process with process waste water recycling ratios of 30 – 50 % by applying a combination of process optimisation measures and process waste water treatment systems as stated in Section 4.4.5.

5.2.7.4 Solid process losses/solid waste

BAT is to reduce the amount of solid process losses/solid waste in the form of used plaster moulds from the shaping by applying one individual or a combination of the following measures (see Section 4.5.2.2):

- a) replacing plaster moulds by polymer moulds
- b) replacing plaster moulds by metal moulds
- c) use of vacuum plaster mixers
- d) re-use of used plaster moulds in other industries.

5.2.8 Technical ceramics

5.2.8.1 Channelled dust emissions

- a) BAT is to reduce channelled dust emissions from spray drying processes to 1 – 30 mg/m³, as the half hourly average value, by applying bag filters (see Section 4.2.3.2), or to 1 – 50 mg/m³ by applying cyclones (see Section 4.2.3.1) in combination with wet dust separators (see Section 4.2.3.4) for existing installations, if the rinsing water can be re-used.

- b) BAT is to reduce channelled dust emissions from spray glazing processes to 1 - 10 mg/m³, as the half hourly average value, by applying bag filters (see Section 4.2.3.2) or sintered lamellar filters (see Section 4.2.3.3).

5.2.8.2 Gaseous compounds/secondary measures/techniques

BAT is to reduce the emissions of gaseous inorganic compounds from the flue-gases of kiln firing processes by applying module adsorbers (see Section 4.3.4.2), especially for lower flue-gas flowrates (below 18000 m³/h) and when raw gas concentrations of inorganic compounds other than HF (SO₂, SO₃, HCl) and of dust are low.

5.2.8.3 Volatile organic compounds

BAT is to reduce the emissions of volatile organic compounds from the flue-gases of firing processes – with raw gas concentrations of more than 100 to 150 mg/m³, depending on the raw gas characteristics, e.g. composition, temperature –to 5 – 20 mg/m³, as the daily average value stated as total C, by applying thermal afterburning either in a one or a three chamber thermoreactor (see Section 4.3.5.1).

5.2.8.4 Solid process losses/solid waste

BAT is to reduce the amount of solid process losses/solid waste in the form of used plaster moulds from the shaping by applying one individual or a combination of the following measures (see Section 4.5.2.2):

- a) replacing plaster moulds by polymer moulds
- b) replacing plaster moulds by metal moulds
- c) use of vacuum plaster mixers
- d) re-use of used plaster moulds in other industries.

5.2.9 Inorganic bonded abrasives

5.2.9.1 Volatile organic compounds

BAT is to reduce the emissions of volatile organic compounds from the flue-gases of firing processes – with raw gas concentrations of more than 100 to 150 mg/m³, depending on the raw gas characteristics, e.g. composition, temperature –to 5 – 20 mg/m³, as the daily average value stated as total C, by applying thermal afterburning either in a one or a three chamber thermoreactor (see Section 4.3.5.1).

6 EMERGING TECHNIQUES FOR CERAMIC MANUFACTURING

6.1 Radiant tube burners

Reduction of water vapour levels in the kiln gases usually results in lower emission rates for fluoride, because the basic mechanism for the release of fluorine from clay minerals is pyrohydrolysis. This reaction occurs at temperatures of 800 °C and upwards.

In laboratory tests, it was found that reducing the water content in the kiln atmosphere, did result in reduced emissions of HF as well as of SO_x. In practice, a reduction of the water content in the kiln atmosphere would be technically difficult to achieve, given that water is produced during the combustion of the fossil fuels used to heat the kiln. This production of water can be avoided by heating the kiln indirectly with gas-fired radiant-tube burners (see Section 4.3.3.2).

For application in the ceramic industry, radiant-tube burners are made of silicon carbide with a high thermal conductivity and a high heat resistance to strongly fluctuating temperatures. With these radiant-tube burners, the kilns are heated indirectly (except the preheating zone of the kiln) and the flame of the burner is placed in a heat resistant tube, where combustion takes place. Heat transfer from the burner to the process is mainly carried out by thermal radiation, the corresponding high values for the heat flux are in a range of between 70 – 120 kW/m².

The radiant-tube burners are, in principle, applicable in the wall and floor tiles, table- and ornamentalware, sanitaryware, technical ceramics and inorganic bonded abrasives industries, but the production scale in the sectors bricks and roof tiles, vitrified clay pipes, refractory products and expanded clay aggregates is too large. Projects have proven that they can be applied in roller hearth kilns and shuttle kilns, although the technology is not yet proven for tunnel kilns.

A pilot project in the Netherlands, where a roller hearth kiln was equipped with radiant tube burners for the manufacture of wall and floor tiles, showed HF emissions of between 0.7 mg/m³ (wall tile manufacture) and 1.2 mg/m³ (floor tile manufacture), and specific HF emission factors of between 3 to 6 mg/kg. The additional costs for radiant tube burner equipment and operating a kiln with a production capacity of 500000 m² tiles per year were estimated at more than EUR 450000 [5, InfoMil, 2003].

6.2 Microwave assisted firing and microwave dryers

The firing or sintering of ceramic ware is a critical step in the manufacturing process. Heavy loads on large kiln cars make the heat transfer from the outside to the middle of the setting and into the centre of individual bricks difficult. Temperature gradients can lead to thermal stresses and damaged products – surface temperatures are frequently higher than those in the centre of the unit or setting.

Considerable research has been conducted on applying microwave energy in the firing of ceramic ware. This process heats the product directly – including the centre of the units. In order to avoid undue heat loss to the kiln structure, microwave energy has been used in combination with conventional heating such as gas or electrical energy.

Technical problems, including safety aspects still need to be solved before the process can be applied economically on full-scale manufacture kilns and also relatively high electrical energy costs have to be taken into account. However, experimental work has indicated a number of significant benefits which should be developed in the future:

- minimisation of thermal stresses throughout the firing cycle
- product throughputs considerably increased, i.e. much shorter firing cycles
- energy consumption for firing considerably reduced – but there may be less excess heat available for drying purposes
- reduction of solid process losses/solid waste
- quality improvements, including significant gain in mechanical properties
- enhanced binder removal (from refractory products)
- reduced emissions based upon less energy consumption and higher production output
- lower fluoride emissions – which are closely related to the time the product spends above 800 °C.

Microwave energy can, in principle, also be used for drying ceramic ware (see Section 2.2.5.8). The advantages and disadvantages, as listed above for firing, are also valid for drying processes with microwave ovens. Research showed that microwave assisted drying is not applicable for complex product shapes, only for thin shapes [20, CERAME-UNIE, 2004] [28, Schorcht, 2005] [30, TWG Ceramics, 2005].

6.3 New type of drying system for refractory products

Description and achieved environmental benefits

The drying of large size refractory building components such as ladle lids or the roofs of electric arc furnaces can be very time consuming and energy intensive. By placing heat resistant stainless steel foils (with heating temperatures of up to 1100 °C) or carbon fibres (at lower drying temperatures of less than 250 °C) as the heating element into the refractory mix which needs to be poured, the component can be dried from the inside out. The foils or carbon fibres adapt to the structure and cause no interference.

As drying takes place from the inside out, the water moves in the same direction as the temperature front. This reduces drying times considerably.

Controlling the setting temperature improves the quality of the building components substantially, resulting in more even drying with fewer dry cracks and improved structural stability. Improvements were achieved in the following parameters:

- cold crushing strength: +50 %
- bending strength: +50 %
- abrasion resistance: +70 %
- extension of service life: +50 %.

This drying technique results in considerable energy savings, which can be further increased – particularly in the case of very large building components – by insulating the refractory product during drying.

Cross-media effects

No issues.

Operational data and applicability

Carbon fibres can be used at temperatures of up to approx. 250 °C, and metal foils at higher temperatures of up to 1100 °C. Tests with a 9 tonne building component showed that the previous energy requirement for drying was 77000 kWh at residual moisture of 6 %. Installation of heating foils and insulation during drying reduced the energy requirement to 2000 kWh, which corresponds to about 97 % savings. The drying time decreased from about five days to about three days.

Economics

Significant cost savings can be achieved, particularly in the case of very large building components with weights of up to 20 tonnes, by reduced energy consumption.

Driving force for implementation

- better quality and longer service life of building components
- cost savings
- time savings.

Example plant and reference literature

The technique is used by several manufacturers, e.g. Wolf GmbH, Urbar, Germany, [30, TWG Ceramics, 2005] [32, TWG Ceramics, 2006].

6.4 Advanced process waste water management with integrated glaze recovery

An innovative model waste water treatment system has been built at a ceramics factory, resulting in considerable reductions in pollutants and savings in the manufacture of sanitaryware, tableware and wall and floor tiles.

The new process waste water system has five modules:

- microfiltration: the process waste water from the largest glazing process (white glazing, 80 % of total glaze consumption) is passed through a microfiltration plant for glaze recovery. The recovered glaze is returned to glaze preparation
- treatment of a tributary process waste water stream: the process waste water from paste preparation in wall and floor tile manufacture, which is low in volume but highly contaminated, is passed to a separate treatment plant. The resulting sewage sludge, which contains high quality components which help increase the sinter ability of the ceramic body, is sent to paste preparation while the effluent goes to the municipal waste water treatment plant for removal of biodegradable constituents
- inclusion of existing sedimentation tanks: the process waste water from glaze preparation is passed through a system of sedimentation tanks, which have been upgraded by additional measures and are monitored automatically. The resulting sewage sludge is also returned to paste preparation in wall and floor tile manufacture while the process waste water is passed to the new, substantially smaller process waste water treatment plant
- construction of a new central process waste water treatment plant: the previous process waste water treatment plant handled up to 3500 m³ of process waste water per day. The developed shed structures in the wall and floor tile works area made it impossible to separate rainwater and production waste water when the first waste water treatment plant was built in the early 1970s. The new centralised plant, which represents current state of the art, collects the process waste water from the factory and pumps it to the new system over ground, so that no mixing with rainwater occurs. An adjustment to the process waste water volumes of 700 – 800 m³/day, the reduced pollutant loads in process waste water streams, and improved technology have made it possible to design it as a fully automated plant whose operation requires only 20 % of the original personnel needs and generates considerable savings in energy and flocculants. Part of the sewage sludge from this plant can also be re-used in tile production. As its pollutant loads are lower and as it also has lower water content (25 % maximum) because of a new chamber filter press, the remainder can be stored at the factory's own disposal site without any risk. Tests showed that the material is also suitable to be used as a component of the mineral sealing layer of landfill final cover systems
- separation of rainwater: as process waste water is separated from the underground sewerage system, costly modernisation of old sewers and shafts is not required. Reduction and automation regarding the use of flocculants promises considerable material and cost savings.

The redesigning of the system has the following environmental advantages

- recovery of white glaze and re-use within the process
- saving of landfill capacity
- use of biocides and activated charcoal filters is no longer necessary
- highly contaminated process waste water is treated separately
- in-plant recycling of sewage sludge
- biologically polluted process waste water fractions are fed to the municipal waste water treatment plant
- no risk from polluted process waste water in the old sewerage system
- energy savings due to adaptation of the plants
- savings in flocculants for sludge separation.

Cost advantages

- reduction of personnel costs to 20 % of the original number of staff required through automation
- reduction of energy costs
- reduction in chemical additives
- recovery of re-usable glaze
- reduction of landfill costs.

The total costs of the process waste water treatment system are EUR 2.8 million. Because of the resulting savings, the expected payback period is 3 – 4 years.

Potential disadvantages

Although the system presented here can be characterised as a model system, the risks that could result when circumstances differ from those described, may lead to the following economic and qualitative disadvantages:

- energy costs for the filtration technology may exceed the savings achieved from recovery of raw materials (depending on the original rate of raw material loss)
- incorrect design of the microfiltration plant with the consequence of excessive investment costs or insufficient capacity
- long phase of research into the use of recovered glaze (colour corrections may be necessary)
- mixing of tributary streams is possible to a limited extent only, otherwise the saving effects from high quality recovery are no longer achieved
- high technical competence is necessary regarding the overall system
- redundancy measures have to be taken into account in the planning phase.

Conclusion: this kind of implementation of state-of-the-art environmental technology continues to be an industrial trial of model character subject to strictly defined conditions [30, TWG Ceramics, 2005] [32, TWG Ceramics, 2006].

6.5 Lead-free glazing of high quality table porcelain

Description and achieved environmental benefits

Lead glazes have been used in the past mainly for high quality table porcelain. The advantages of lead glazing include perfect surfaces and simple processing techniques in particular due to the melting and wetting behaviour typical of glazes containing lead.

Lead-free glaze formulations based on alkali boron silicates have been developed by a tableware producer, which are very much like systems containing lead in terms of quality and properties of application. This has led to annual savings in lead oxide of 60 tonnes. The use of minimal quantities of organic process additives means that environmental impacts due to organic emissions during firing are largely avoided.

The glazes are applied by wet spraying using rheologically adapted glazing suspensions. Process waste water streams generated in the spray booth, such as overspray and water from booth and rack cleaning, as well as glaze dust from the dry separator are treated and re-used for glazing together with fresh glaze. This closed glazing cycle has made it possible to optimise glaze input (glaze losses and actual requirement). The downstream thermal processes drying and firing have been adapted to the new glazing systems and optimised.

Simple patterns do not require additional firing and can be baked together with the glaze using an under-glaze technique. Complex, coloured on- and in-glaze patterns have to be baked separately.

Cross-media effects

A higher energy requirement is needed for the treatment and recovery of process waste water from glaze application.

Operational data and applicability

This technique is used for high quality table porcelain. Its use for colourful under-glaze patterns is not yet possible or would require additional investment.

Economics

With this technique, the manufacturer currently makes annual savings in lead oxide of 60 tonnes at two production sites. The conversion to this technique was carried out in the framework of a fundamental optimisation of the whole process. The implementation of this technique as part of modern process technology has led to increased economic viability and competitiveness in the world market.

Driving force for implementation

Cost savings for feedstock and the prevention of lead emissions.

Example plants and reference literature

Villeroy & Boch AG, Germany, [30, TWG Ceramics, 2005], [32, TWG Ceramics, 2006]

7 CONCLUDING REMARKS

Timing of the work process

The information exchange on Best Available Techniques for Ceramic Manufacturing was carried out from late 2003 to the beginning of 2006 within the international technical working group (TWG) which was established for this purpose. It took approximately two and a half years to draft and develop this document based on the information provided and comments arising from the two consultations and the final TWG meeting. Table 7.1 shows the milestones of the work.

Start of Ceramics BREF work	October 2003
Kick-off meeting	1 – 2 December 2003
Draft 1	October 2004
Draft 1 comments	January 2005
Draft 2	June 2005
Draft 2 comments	September 2005
Change of the BREF author	September 2005
Final TWG meeting	14 – 17 February 2006
Final draft	September 2006

Table 7.1: Timing of the work process on the BREF on Ceramic Manufacturing

Sources of information and development of this document

This document is based on over 30 sources of information, with key information from both industry and Member States. Some reports were elaborated already prior to the kick-off meeting on purpose to provide targeted information for the development of this document and many contributions were also provided after the kick-off meeting. The reports were submitted by CERAME UNIE, the industry association representing the majority of European ceramic manufacturers, and the Member States Austria, Belgium, Finland, Germany, Italy, the Netherlands, Portugal and Spain and can be considered the building blocks of this document.

Additional useful information was obtained by visiting ceramic manufacturing sites in Austria, Belgium, Denmark, Finland, France, Germany, Italy and Spain, usually organised and accompanied by TWG members.

This document was developed based on about 1000 comments to the first draft and more than 750 comments to the second draft from almost all of the TWG members. In this context it has to be noted that in fact the information exchange was carried out within EU-15, because the 10 new Member States of EU-25, with a few exceptions, did not participate actively.

Based on the information provided and the comments received, the scope and the structure of this document were developed so that the nine major ceramic sectors are covered. These are:

- wall and floor tiles
- bricks and roof tiles
- table- and ornamentalware (household ceramics)
- refractory products
- sanitaryware
- technical ceramics
- vitrified clay pipes
- expanded clay aggregates
- inorganic bonded abrasives.

The order of the chapters of this document (Executive Summary, Preface, Scope, Chapters 1 – 9 including BAT – Chapter 5 and Concluding Remarks – Chapter 7) follows the standard order of the BREF Outline and Guide. This BREF Outline and Guide was given by the Information Exchange Forum (IEF), which is established by the European Commission to assist the IPPC information exchange (in this context, see also the Preface).

Information gaps that still exist

Despite much very useful information and many comments provided, regarding several issues, some data problems and the corresponding consequences for the document have to be pointed out:

- to a certain extent, a lack of consistent quantitative information regarding actual economic (cost) data for some abatement techniques other than flue-gas cleaning techniques in context with the corresponding performance data. This has resulted in some qualitative rather than quantitative economic statements especially in Chapter 4 and consequently in some BAT conclusions, which are now based mainly on a qualitative approach
- the multitude of product groups and individual manufacturing process steps have also led to qualitative rather than quantitative statements especially the BAT conclusions regarding energy efficiency. The data which were submitted in this context, show many specific aspects or details, but lead to the conclusion that, until now, general quantitative statements regarding this issue can hardly be made
- regarding the use of alternative (e.g. biogas/biomass) or solid fuels (e.g. coal, petroleum coke) only few emission and consumption data were provided, most of them very late in this document's development process – some of them even during the final TWG meeting – and therefore they could not be fully taken into consideration.

Level of consensus at the final TWG meeting

The main discussion items at the final TWG meeting were the BAT conclusions, which were set out on two levels:

- generic BAT conclusions, i.e. those that are generally applicable to the whole ceramic industry
- sector specific BAT conclusions, i.e. those for the nine major ceramic sectors under the scope.

The BAT proposals were discussed case by case and in this context, it was also discussed and concluded that the BAT chapter does not set or propose emission limit values but suggests consumption and emission values that are associated with the use of a selection of BAT and that 'Best Available Techniques' for a specific installation will usually be the use of one individual or a combination of the techniques and measures listed in the BAT chapter under the generic and sector specific sections.

Another discussion point was to explicitly mention in the Concluding Remarks Chapter the difficulties in handling the information which was received very late. This is in particular relevant to petroleum coke as a fuel for the kiln firing process, along with the recommendation for further information gathering in order to help with the updating of this ceramics document.

A high degree of consensus was achieved during the final TWG meeting, no split views were recorded, and therefore – as also seen retrospectively over the whole information exchange period – the information exchange process can be considered successful.

Recommendations for future work

The information exchange and its result, i.e. this document, present an important step forward in achieving the integrated prevention and control of pollution from ceramic manufacturing. Further work could continue the process by providing information from all EU-25 Member States including actual cost data of abatement techniques and more data on energy efficiency linked with the corresponding techniques.

Also more information regarding alternative and solid fuels including all kinds of emission and consumption data, e.g. real measured emission data, will be necessary to obtain a full understanding of the emission behaviour for a future revision of this document.

Additionally, the BAT associated emission levels (BAT AEL) have to be peer reviewed for a revision of this document, in particular regarding the high BAT AEL range for SO_x emissions from the kiln firing process by using raw material with high sulphur content, taking into account advancing abatement techniques.

For the revision of this document, an oxygen level of 17 % should be considered as the reference level.

Suggested topics for future R&D work

In particular regarding the techniques described in the Emerging Techniques Chapter (Chapter 6), some future R&D work will still be necessary and useful, so that these techniques can be considered in the determination of BAT for ceramic manufacturing.

Besides that, the EC is launching and supporting, through its RTD programmes, a series of projects dealing with clean technologies, emerging effluent treatment and recycling technologies and management strategies. Potentially these projects could provide a useful contribution to future BREF reviews. Readers are therefore invited to inform the EIPPCB of any research results which are relevant to the scope of this document (see also the preface of this document).

8 REFERENCES

- 1 BMLFUW (2003). "Austrian Study on State of the Art of Manufacturing Ceramic Goods by Firing".
- 2 VITO (2003). "The Flemish BAT-report on the ceramic industry (brick and roof tile industry), English translation of parts of the original Dutch version - published in 1999".
- 3 CERAME-UNIE (2003). "Proposed Best Available Techniques (BAT) Reference Document (BREF) for the European Ceramic Industry, Rev. Nov. 2003".
- 4 UBA (2001). "Exemplary Investigation into the State of Practical Realisation of Integrated Environmental Protection within the Ceramics Industry under Observance of the IPPC-Directive and the Development of BAT Reference Documents".
- 5 InfoMil (2003). "Dutch Fact Sheets for the Production of Ceramics".
- 6 Timellini, G., Canetti, A. (2004). "The Italian Ceramic Tile Industry. Contribution to the identification and specification of the Best Available Techniques".
- 7 Dodd, A., Murfin, D. (1994). "Dictionary of Ceramics", The Institute of Materials.
- 8 Ullmann's (2001). "Encyclopedia of Industrial Chemistry, Sixth Edition", Wiley-VCH Verlag GmbH, Weinheim, Germany.
- 10 Navarro, J. E. (1998). "Integrated Pollution Prevention and Control in the Ceramic Tile Industry. Best Available Techniques (BAT)".
- 11 Shreve, R. N. (1945). "The Chemical Process Industries, The Ceramic Industries", McGraw-Hill Chemical Engineering Series.
- 12 CTCV (2004). "Portuguese Ceramic Industry Data".
- 13 SYKE (2004). "The contribution of Finland to the exchange of information in the EU on the use of BAT to control the environmental impact of the manufacture of ceramic products, DRAFT June 28, 2004".
- 14 UBA (2004). "Production of inorganic bonded abrasives".
- 17 Burkart, M. (2004). "Personal Communication by site visits".
- 20 CERAME-UNIE (2004). "Proposed Best Available Techniques (BAT) Reference Document (BREF) for the European Ceramic Industry, Rev. Jan. 2004".
- 21 Almeida, M., Vaz, S., Baio, D. (2004). "Impactes Ambientais e Comércio de Emissões Indústria Cerâmica - Un caso de estado".
- 22 SYKE (2004). "Report on Best Available Techniques in the Finnish ceramic industry".
- 23 TWG Ceramics (2005). "Merged and sorted comments master spread sheet on draft 1".
- 24 VKI-Germany (2004). "Breviary Technical Ceramics".
- 25 Volland, T., Leuenberger, C., Roque, R. (2004). "Statistic correlations between two methods of pollutant emission evaluation", L'INDUSTRIE CÉRAMIQUE & VERRIÈRE, No 994 - Mai-Juin 2004, pp. 54 - 66.

References

- 26 UBA (2005). "Basic information and data on the expanded clay industry in Germany", Compilation by German National Working group and German expanded clay industry.
- 27 VDI (2004). "Emission control ceramic industry, VDI Guideline 2585, Draft July 2004".
- 28 Schorcht, F. (2005). "Personal Communication by site visits".
- 29 IMA-Europe (2005). "IMA-Europe's comments on the inclusion of calcined clays, 4. May 2005".
- 30 TWG Ceramics (2005). "Merged and sorted comments master spread sheet on draft 2".
- 31 Probst, R. (2005). "Development of processes for cleaning ceramic waste water", cfi ceramic forum international Berichte der Deutschen Keramischen Gesellschaft.
- 32 TWG Ceramics (2006). "Final TWG meeting Ceramics".

9 GLOSSARY

ENGLISH TERM	MEANING
absorption	a volume process, in which one substance permeates another (soaking up).
acid	proton donor. A substance that, more or less readily, gives off hydrogen ions in a water solution.
acidification	adding acid to a substance to achieve acidic properties.
acute effect	an adverse effect on any living organism in which severe symptoms develop rapidly and often subside after the exposure stops.
acute toxicity	adverse effects that result from a single dose or single exposure of a chemical; any poisonous effect produced within a short period of time, usually less than 96 hours. This term is normally used to describe effects in experimental animals.
adsorption	a surface process; the accumulation of molecules of a gas or liquid to form a thin film on the surface of a solid (surface assimilation).
aeration	the act of mixing a liquid with air (oxygen).
aerobic	a biological process that occurs in the presence of oxygen
alkali	proton acceptor. A substance that, more or less readily, takes up hydrogen ions in a water solution.
anaerobic	a biological process which occurs in the absence of oxygen.
AOCI	adsorbable organic chlorine compounds.
AOX	adsorbable organic halogen compounds. The total concentration in milligrams per litre, expressed as chlorine, of all halogen compounds (except fluorine) present in a sample of water that are capable of being adsorbed on activated carbon.
atm	normal atmosphere (1 atm = 101325 N/m ²).
bar	bar (1.013 bar = 1 atm).
BAT	best available techniques
BAT AEL	BAT associated emission level
BF	batch wise flocculation.
BFW	boiler feed-water to produce steam.
biochemicals	Chemicals that are either naturally occurring or identical to naturally occurring substances. Examples include hormones, pheromones and enzymes. Biochemicals function as pesticides through non-toxic, non-lethal modes of action, such as disrupting the mating pattern of insects, regulating growth or acting as repellents.
biodegradable	that can be broken down physically and/or chemically by micro-organisms. For example, many chemicals, food scraps, cotton, wool and paper are biodegradable.
biodiversity	the number and variety of different organisms in the ecological complexes in which they naturally occur. Organisms are organised at many levels, ranging from complete ecosystems to the biochemical structures that are the molecular basis of heredity. Thus, the term encompasses different ecosystems, species and genes that must be present for a healthy environment. A large number of species must characterise the food chain, representing multiple predator-prey relationships.
biscuit	(1) pottery that has been fired but not yet glazed. (2) this word, meaning 'unglazed', is used in compound terms such as 'biscuit firing'.
BOD	biochemical oxygen demand: the quantity of dissolved oxygen required by micro-organisms in order to decompose organic matter. The unit of measurement is mg O ₂ /l. In Europe, BOD is usually measured after 3 (BOD ₃), 5 (BOD ₅) or 7 (BOD ₇) days.

ENGLISH TERM	MEANING
body	(1) a blend of raw materials awaiting shaping into ceramic products. (2) the interior part of pottery, as distinct from the glaze.
BREF	BAT reference document.
BTEX	benzene, toluene, ethylbenzene, xylene
BTX	benzene, toluene, xylene
calcite	crystalline form of calcium carbonate
cassette	special shaped kiln furniture to support, e.g. roof tiles during firing.
CEN	European Committee for Standardization
ceramics	generally the term 'ceramics' (ceramic products) is used for inorganic materials (with possibly some organic content), made up of non-metallic compounds and hardened by a firing process
chalk	amorphous type of calcium carbonate
clay	a natural material characterised by its plasticity, as taken from the clay pit or after it has been ground and mixed with water.
COD	chemical oxygen demand: the amount of potassium dichromate, expressed as oxygen, required to chemically oxidise at approx. 150 °C substances contained in waste water.
cross-media effects	the calculation of the environmental impacts of water/air/soil emissions, energy use, consumption of raw materials, noise and water extraction (i.e. everything required by the IPPC Directive).
dH	grade of water hardness
diffuse emission	emissions arising from direct contact of volatile or light dusty substances with the environment (atmosphere, under normal operating circumstances). These can result from: <ul style="list-style-type: none"> - inherent design of the equipment (e.g. filters, dryers, etc.) - operating conditions (e.g. during transfer of material between containers) - type of operation (e.g. maintenance activities) - or from a gradual release to other media (e.g. to cooling water or waste water). Fugitive emissions are a subset of diffuse emissions.
diffuse sources	sources of similar diffuse or direct emissions which are multiple and distributed inside a defined area.
DN	nominal width.
dolomite	type of limestone the carbonate fraction of which is dominated by the mineral dolomite, calcium magnesium carbonate, CaMg(CO ₃).
DS	dry solids (content). The mass of a material remaining after drying by the standard method of test.
EC50	effect concentration 50. The concentration at which effects are observed in 50 % of the test population after administering a single dose. Effects include the immobilisation of daphnia, inhibition of growth, cell division or biomass production, or the production of chlorophyll by algae.
effluent	physical fluid (air or water together with contaminants) forming an emission.
EIPPCB	European IPPC Bureau.
emission	the direct or indirect release of substances, vibrations, heat or noise from individual or diffuse sources in the installation into the air, water or land.
emission limit values	the mass, expressed in terms of certain specific parameters, concentration and/or level of an emission, which may not be exceeded during one or more periods of time.

ENGLISH TERM	MEANING
end-of-pipe technique	a technique that reduces final emissions or consumptions by some additional process but does not change the fundamental operation of the core process. Synonyms: 'secondary technique', 'abatement technique'. Antonyms: 'process-integrated technique', 'primary technique' (a technique that in some way changes the way in which the core process operates thereby reducing raw emissions or consumptions).
engobe	a coating of slip, white or coloured, applied to a porous ceramic body to improve its appearance.
ESP	electrostatic precipitator.
eutrophication	the pollution of a body of water by sewage, fertilisers washed from the land, and industrial wastes (inorganic nitrates and phosphates). These compounds stimulate the growth of algae, reducing the oxygen content in the water, and so killing animals with a high oxygen requirement.
existing installation	an installation in operation or, in accordance with legislation existing before the date on which this Directive is brought into effect, an installation authorised or in the view of the competent authority the subject of a full request for authorisation, provided that that installation is put into operation no later than one year after the date on which this Directive is brought into effect.
firing	the process of heat treatment of ceramic ware in a kiln to develop a vitreous or crystalline bond, thus giving the ware properties associated with a ceramic material.
flue-gas	off-gas from firing/combustion processes.
flux	a substance that, even in small quantities, lowers the fusion point of material in which it is naturally present (e.g. alkalis in clay) or of material to which it has been added (e.g. borax added to glazes).
frit	a ceramic composition that has been fused, quenched to form a glass and usually granulated.
fuel oil EL	fuel oil extra light
fugitive emission	emission caused by non-tight equipment/leak: emission into the environment resulting from a gradual loss of tightness from a piece of equipment designed to contain an enclosed fluid (gaseous or liquid), basically caused by a difference of pressure and a resulting leak. Examples of fugitive emissions: leak from a flange, a pump, a sealed or tightened equipment, etc.
GDP	gross domestic product.
GJ	gigajoule.
glass	a solid with no long range order in the arrangement of its atoms.
glaze	a thin glassy layer formed on the surface of a ceramic product by firing-on an applied coating.
glost	this word, meaning 'glazed', is used in compound terms such as 'glost ware' and 'glost firing'.
green ware	ceramic products, shaped, but not dried or fired
HFO	heavy fuel oil.
hPa	hectopascal.
IEF	Information Exchange Forum (informal consultation body in the framework of the IPPC Directive).
immission	occurrence and level of polluting substance, odour or noise in the environment.

ENGLISH TERM	MEANING
installation	a stationary technical unit where one or more activities listed in Annex I of the IPPC Directive are carried out, and any other directly associated activities which have a technical connection with the activities carried out on that site and which could have an effect on emissions and pollution.
IPPC	integrated pollution prevention and control.
I-TEQ	dioxin/furan toxicity equivalent.
K	Kelvin (0 °C = 273.15 K).
kaolin	name derived from Chinese Kao-Lin, a high ridge where this white firing clay was first discovered (also named China Clay).
kcal	kilocalorie (1 kcal = 4.19 kJ).
kiln	a high temperature installation used for firing ceramic ware.
kiln capacity	fired volume of the kiln.
kiln furniture	general term for pieces of refractory material used for the support of ceramic products during kiln firing ('firing auxiliaries').
facing brick	a type of building brick, which may be either of engineering-brick or facing-brick quality with low water absorption and high crushing strength.
kWh	kilowatt-hour (1 kWh = 3600 kJ = 3.6 MJ).
LAS	linear alkylbenzene sulphonate.
LC50	lethal concentration 50. The lowest concentration of a substance in water or ambient air in milligrams per litre sufficient to cause death in 50 % of the test population within a defined period (e.g. 96 hours for fish, 48 hours for daphnia).
LD50	lethal dose 50. The lowest dose of a substance administered to species such as mice and rats sufficient to cause death in 50 % of the test population within a defined period (no more than 14 days), expressed in milligrams of test substance per kilogram of bodyweight.
limestone	mineral rock consisting merely of CaCO ₃ ; used as such or as raw material to produce by decarbonisation quicklime (calcium oxide) and by hydration of quicklime, hydrated lime (calcium hydroxide)
LNG	liquefied natural gas.
LOEC	lowest observed effect concentration. The lowest experimentally determined concentration of a test substance at which adverse effects can be observed.
LPG	liquefied petroleum gas.
LWA	lightweight expanded clay aggregate: a bloated clay aggregate made by the sudden heating of suitable clays either in a rotary kiln or on a sinter-hearth.
m ³ /h	volume flow: if not otherwise mentioned in this document, the volume flows refer to 18 vol-% oxygen and standard state.
magnesia	magnesium oxide (MgO).
magnesite	magnesium carbonate (MgCO ₃).
mg/m ³	concentration: if not otherwise mentioned in this document, the concentrations of gaseous substances or mixtures of substances refer to dry flue-gas at 18 vol-% oxygen and standard state, and benzene concentrations refer to 15 vol-% oxygen and standard state.
MJ	megajoule (1 MJ = 1000 kJ = 10 ⁶ J).
monitoring	process intended to assess or to determine the actual value and the variations of an emission or another parameter, based on procedures of systematic, periodic or spot surveillance, inspection, sampling and measurement or another assessment methods intended to provide information about emitted quantities and/or trends for emitted pollutants.
MPa	megapascal.

ENGLISH TERM	MEANING
multi-media effects	see cross-media effects.
n/a	not applicable.
n.a.	not available.
naphthenes	hydrocarbons containing one or more saturated rings of 5 or 6 carbon atoms in their molecules, to which paraffinic-type branches are attached (adjective: naphthenic).
n/d	no data.
N-Kj	nitrogen analysed by Kjeldahl method.
Nm ³	normal cubic metre (273 K, 1013 hPa).
NOAC	no observed acute effect concentration.
NOEC	no observed effect concentration.
off-gas	general term for gas/air released during combustion processes or extraction processes at ambient temperatures.
operator	any natural or legal person who operates or controls the installation or, where this is provided for in national legislation, to whom decisive economic power over the technical functioning of the installation has been delegated.
particulate matter	dust.
pH	symbol for the acidity or alkalinity of a solution. It is a number equivalent to the logarithm, to the base of 10, of the reciprocal of the concentration of hydrogen ions in an aqueous solution.
pollutant	individual substance or group of substances which can harm or affect the environment.
pottery	this term is generally understood to mean domestic ceramic ware.
ppm	parts per million.
primary measure/technique	a technique that in some way changes the way in which the core process operates thereby reducing raw emissions or consumptions (see end-of-pipe technique).
PTFE	Polytetrafluoroethylene (Teflon).
rpm	revolutions per minute.
secondary measure/technique	see end-of-pipe technique.
setting density	mass of the ware to be fired without firing auxiliaries in the fired volume of the kiln in reference to the overall fired volume of the kiln.
sintering	general term for the densification by heat of a powder compact to produce a polycrystalline body.
slip	a suspension of clay and/or other ceramic materials in water.
sludge	a suspension with a relatively high solids content.
SME	small and medium enterprise(s).
sorption	the process, in which one substance takes up or holds another by either absorption or adsorption.
specific emission	emission related to a reference basis, such as production capacity, or actual production (e.g. mass per tonne or per unit produced).
SS	suspended solids (content) (in water) (See also TSS).
standard state	refers to a temperature of 273 K and a pressure of 1013 hPa.
TJ	terajoule.
TOC	total organic carbon.
TS	total solids (content). Solid content before drying of the material.
TSS	total suspended solids (content) (in water) (See also SS).
TWG	technical working group.
vitreous	this term meaning 'glassy', is applied to ceramic ware, that as a result of a high degree of vitrification (as distinct from sintering) has an extremely low porosity.
vitrification	the progressive partial fusion of a clay, or of a body, as a result of a firing process.

ENGLISH TERM	MEANING
VOC	volatile organic compounds.
vol-%	percentage by volume.
W/(mK)	thermal conductivity.
wt-%	percentage by weight.
µg	microgram.
µS	microsiemens.

CHEMICAL SYMBOLS

Al...Aluminium	H ₂ O...Water	PbO...Lead oxide
Al ₂ O ₃ ... Aluminium oxide	HCl...Hydrogen chloride	Pr...Praseodymium
BaO...Barium oxide	HCN...Hydrocyanic acid	Pt...Platinum
BN...Boron nitride	HF...Hydrogen fluoride	Rh...Rhodium
Ca...Calcium	K ₂ O...Potassium oxide	S...Sulphur
Ca(OH) ₂ ...Calcium hydroxide	MgCO ₃ ...Magnesium carbonate	Sb...Antimony
CaCl ₂ ...Calcium chloride	MgO...Magnesium oxide	Si...Silicon
CaCO ₃ ...Calcium carbonate	Mn...Manganese	SiC...Silicon carbide
CaF ₂ ...Calcium fluoride	Mo...Molybdenum	SiO ₂ ...Silicon dioxide
CaO...Calcium oxide	Na ₂ CO ₃ ...Sodium carbonate	Sn...Tin
CaSO ₃ ...Calcium sulphite	Na ₂ O...Sodium oxide	SO ₂ ...Sulphur dioxide
CaSO ₄ ...Calcium sulphate	Na ₂ SO ₃ ...Sodium sulphite	SO ₃ ...Sulphur trioxide
Cd...Cadmium	NaCl...Sodium chloride	SO _x ...Sulphur oxides
Ce...Cerium	NaF...Sodium fluoride	Ti...Titanium
Co...Cobalt	NaHCO ₃ ...Sodium hydrogen carbonate	TiN...Titanium nitride
CO...Carbon monoxide	NaOH...Sodium hydroxide	TiO ₂ ...Titanium dioxide
CO ₂ ...Carbon dioxide	NH ₃ ...Ammonia	V...Vanadium
Cr...Chromium	Ni...Nickel	W...Tungsten
Cu...Copper	NO ₂ ...Nitrogen dioxide	WB ₂ ...Tungsten boride
F...Fluorine	NO _x ...Nitrogen oxides	Zn...Zinc
Fe...Iron	O ₂ ...Oxygen	Zr...Zirconium
Fe ₂ O ₃ ...Iron oxide	Pb...Lead	ZrO ₂ ...Zirconium dioxide